

# User Manual



## AFG310 and AFG320 Arbitrary Function generator

**071-0175-50**

Copyright © Tektronix Japan, Ltd. All rights reserved.

Copyright © Tektronix, Inc. All rights reserved.

Tektronix products are covered by U.S. and foreign patents, issued and pending. Information in this publication supercedes that in all previously published material. Specifications and price change privileges reserved.

Tektronix Japan, Ltd., 5-9-31 Kitashinagawa, Shinagawa-ku, Tokyo 141-0001 Japan

Tektronix, Inc., P.O. Box 500, Beaverton, OR 97077

TEKTRONIX and TEK are registered trademarks of Tektronix, Inc.

## WARRANTY

Tektronix warrants that the products that it manufactures and sells will be free from defects in materials and workmanship for a period of three (3) years from the date of shipment. If a product proves defective during this warranty period, Tektronix, at its option, either will repair the defective product without charge for parts and labor, or will provide a replacement in exchange for the defective product.

In order to obtain service under this warranty, Customer must notify Tektronix of the defect before the expiration of the warranty period and make suitable arrangements for the performance of service. Customer shall be responsible for packaging and shipping the defective product to the service center designated by Tektronix, with shipping charges prepaid. Tektronix shall pay for the return of the product to Customer if the shipment is to a location within the country in which the Tektronix service center is located. Customer shall be responsible for paying all shipping charges, duties, taxes, and any other charges for products returned to any other locations.

This warranty shall not apply to any defect, failure or damage caused by improper use or improper or inadequate maintenance and care. Tektronix shall not be obligated to furnish service under this warranty a) to repair damage resulting from attempts by personnel other than Tektronix representatives to install, repair or service the product; b) to repair damage resulting from improper use or connection to incompatible equipment; c) to repair any damage or malfunction caused by the use of non-Tektronix supplies; or d) to service a product that has been modified or integrated with other products when the effect of such modification or integration increases the time or difficulty of servicing the product.

**THIS WARRANTY IS GIVEN BY TEKTRONIX IN LIEU OF ANY OTHER WARRANTIES, EXPRESS OR IMPLIED. TEKTRONIX AND ITS VENDORS DISCLAIM ANY IMPLIED WARRANTIES OF MERCHANTABILITY OR FITNESS FOR A PARTICULAR PURPOSE. TEKTRONIX' RESPONSIBILITY TO REPAIR OR REPLACE DEFECTIVE PRODUCTS IS THE SOLE AND EXCLUSIVE REMEDY PROVIDED TO THE CUSTOMER FOR BREACH OF THIS WARRANTY. TEKTRONIX AND ITS VENDORS WILL NOT BE LIABLE FOR ANY INDIRECT, SPECIAL, INCIDENTAL, OR CONSEQUENTIAL DAMAGES IRRESPECTIVE OF WHETHER TEKTRONIX OR THE VENDOR HAS ADVANCE NOTICE OF THE POSSIBILITY OF SUCH DAMAGES.**



# Table of Contents

|                            |                                     |            |
|----------------------------|-------------------------------------|------------|
|                            | <b>General Safety Summary</b> ..... | <b>ix</b>  |
|                            | <b>Preface</b> .....                | <b>xi</b>  |
| <b>Getting Started</b>     |                                     |            |
|                            | Product Description .....           | 1-1        |
|                            | Initial Inspection .....            | 1-2        |
|                            | Power Cord Options .....            | 1-2        |
|                            | Accessories .....                   | 1-3        |
|                            | Installation .....                  | 1-4        |
|                            | Cooling .....                       | 1-4        |
|                            | Repackaging for Shipment .....      | 1-12       |
| <b>Operating Basics</b>    |                                     |            |
|                            | <b>Operating Basics</b> .....       | <b>2-1</b> |
|                            | Controls and Connectors .....       | 2-2        |
|                            | Basic Menu Operations .....         | 2-6        |
|                            | Tutorials .....                     | 2-27       |
| <b>Reference</b>           |                                     |            |
|                            | Menu Structure .....                | 3-1        |
|                            | Menu Button Functions .....         | 3-8        |
| <b>Syntax and Commands</b> |                                     |            |
|                            | Remote Interface .....              | 4-1        |
|                            | Command Syntax .....                | 4-5        |
|                            | Command Groups .....                | 4-16       |
|                            | Command Descriptions .....          | 4-28       |
|                            | Programming Examples .....          | 4-76       |
| <b>Status and Events</b>   |                                     |            |
|                            | Error and Event Status Block .....  | 5-1        |
|                            | Registers .....                     | 5-3        |
|                            | Event Codes and Messages .....      | 5-10       |

## Appendices

|  |            |
|--|------------|
| <b>Appendix A: Specifications</b> .....                      | <b>A-1</b> |
| <b>Appendix B: Self Test and Calibration Procedure</b> ..... | <b>B-1</b> |
| <b>Appendix C: Inspection and Cleaning</b> .....             | <b>C-1</b> |
| <b>Appendix D: Floating Connections</b> .....                | <b>D-1</b> |
| <b>Appendix E: Miscellaneous</b> .....                       | <b>E-1</b> |

## Index

# List of Figures

|  |      |
|--|------|
| <b>Figure 1–1: Rack Mount Kit (EIA)</b> .....  | 1–4  |
| <b>Figure 1–2: Cooling for rackmounted instrument(s)</b> .....   | 1–5  |
| <b>Figure 1–3: Bench Top Installation</b> .....  | 1–5  |
| <b>Figure 1–4: Rear Panel Controls</b> .....   | 1–6  |
| <b>Figure 1–5: POWER Switch</b> .....  | 1–10 |
| <b>Figure 1–6: The LCD Display at Power On</b> .....   | 1–10 |
| <b>Figure 1–7: The LCD Display When Error is Found</b> .....   | 1–11 |
| <br>   |      |
| <b>Figure 2–1: Front Panel Controls</b> .....  | 2–2  |
| <b>Figure 2–2: Rear Panel</b> .....  | 2–4  |
| <b>Figure 2–3: Default Display</b> .....   | 2–7  |
| <b>Figure 2–4: Menu Item Display</b> .....   | 2–8  |
| <b>Figure 2–5: Item Buttons and Main Menu Buttons</b> .....  | 2–8  |
| <b>Figure 2–6: Display Example for a Main Menu Selected</b> .....  | 2–9  |
| <b>Figure 2–7: Display Example for a Numeric Item Selected</b> .....   | 2–10 |
| <b>Figure 2–8: Buttons and Keys for Inputting Numeric Value</b> .....  | 2–11 |
| <b>Figure 2–9: Example for Inputting Numeric Value</b> .....   | 2–11 |
| <b>Figure 2–10: Buttons for Changing Numeric Value</b> .....   | 2–12 |
| <b>Figure 2–11: CH Button and Channel Indicators</b> .....   | 2–14 |
| <b>Figure 2–12: Sin(X)/X Pulse</b> .....   | 2–20 |
| <b>Figure 2–13: Double Exponential Pulse</b> .....   | 2–21 |
| <b>Figure 2–14: Damped Sine Wave</b> .....   | 2–21 |
| <b>Figure 2–15: Pseudo-random Signals Generated with Shift Register</b> .....  | 2–22 |
| <b>Figure 2–16: NRZ Random Signal</b> .....  | 2–22 |
| <b>Figure 2–17: Hookup for Observing Output Waveforms</b> .....  | 2–28 |
| <b>Figure 2–18: OUTPUT Switches and Indicators on the Front Panel</b> .  | 2–32 |
| <b>Figure 2–19: MANUAL Button on the Front Panel</b> .....   | 2–33 |
| <b>Figure 2–20: Setup for Sweep Parameters</b> .....   | 2–33 |
| <b>Figure 2–21: Hookup for Observing Output Waveforms</b> .....  | 2–34 |
| <b>Figure 2–22: User Waveform to be Created</b> .....  | 2–38 |
| <b>Figure 2–23: Hookup for Observing Output Waveforms</b> .....  | 2–38 |
| <b>Figure 2–24: Fixed points (one period signal) User Waveform when<br/>Output Frequency = Display Frequency = 32 kHz.</b> ..... | 2–45 |
| <b>Figure 2–25: Fixed points (one period signal) User Waveform when<br/>Output Frequency = Display Frequency = 16 kHz.</b> ..... | 2–45 |

|  |      |
|--|------|
| Figure 2–26: Fixed points (one period signal) User Waveform when<br>Output Frequency = Display Frequency = 8 kHz. ....                                 | 2–45 |
| Figure 2–27: Variable points (one period signal) User Waveform when<br>Output Frequency = Display Frequency = 16 kHz , 256 kHz Internal<br>clock ..... | 2–46 |
| Figure 2–28: Variable points (one period signal) User Waveform when<br>Output Frequency = Display Frequency = 16 kHz , 512 kHz Internal<br>clock ..... | 2–46 |
| Figure 2–29: Fixed point (one period signal) User Waveform when<br>Output Frequency = Display Frequency = 32 kHz. ....                                 | 2–47 |
| Figure 2–30: Fixed point User Waveform when<br>(two period signal) Display Frequency = 32 kHz,<br>(one period signal) Output Frequency = 64 kHz. ....  | 2–47 |
| Figure 2–31: Hookup for Importing Waveform .....   | 2–48 |
|  |      |
| Figure 3–1: Setting Menu Structure .....   | 3–2  |
| Figure 3–2: Parameter Menu Structure .....   | 3–4  |
| Figure 3–3: Edit Menu Structure .....  | 3–5  |
| Figure 3–4: Recall and Save Menu Structure .....   | 3–6  |
| Figure 3–5: System Menu Structure .....  | 3–7  |
| Figure 3–6: Location of the SHIFT Button and Indicator .....   | 3–8  |
| Figure 3–7: Channel Indicators .....   | 3–8  |
| Figure 3–8: Pulse Duty .....   | 3–14 |
| Figure 3–9: Timing Chart in the Triggered Mode .....   | 3–14 |
| Figure 3–10: Timing Chart in the Burst Mode .....  | 3–15 |
| Figure 3–11: Timing Chart of Dual Channel Instrument .....   | 3–16 |
| Figure 3–12: Relationship between External Modulating Wave and<br>AM Modulated Output .....  | 3–18 |
| Figure 3–13: Frequency Sweep in Case of “START < STOP” .....   | 3–19 |
| Figure 3–14: Spacing Type .....  | 3–20 |
| Figure 3–15: FSK Modulation .....  | 3–22 |
| Figure 3–16: Add or Delete Data by Changing Number of Points ...   | 3–23 |
| Figure 3–17: Append a Waveform at the End of the Edit Waveform   | 3–24 |
| Figure 3–18: Append a Waveform to the Front of the Edit Waveform   | 3–25 |
| Figure 3–19: LCD Display When LINE Item is Selected and<br>Confirmed .....   | 3–26 |
| Figure 3–20: Example of LINE Editing on the Three Points .....   | 3–26 |
| Figure 3–21: LCD Display When CUT Item is Selected and<br>Confirmed .....  | 3–27 |
| Figure 3–22: Example of Cutting Data Between Specified Points ...  | 3–28 |
| Figure 3–23: Error Display When Errors Were Detected .....   | 3–36 |



---

|   |             |
|---|-------------|
| <b>Figure 3–24: Error Display When Errors Were Detected</b> .....                         | <b>3–37</b> |
| <b>Figure 4–1: IEEE STD 488 Port</b> .....  | <b>4–2</b>  |
| <b>Figure 4–2: GPIB System Configurations</b> .....                                       | <b>4–2</b>  |
| <b>Figure 4–3: LCD Display When GPIB ADDRESS Item is Displayed</b>                        | <b>4–3</b>  |
| <b>Figure 4–4: LCD Display When GPIB CONFIG Item is Displayed</b> .                       | <b>4–4</b>  |
| <b>Figure 4–5: Program Messages and Response Messages</b> .....                           | <b>4–6</b>  |
| <b>Figure 4–6: GPIB: Retrieving Response Messages</b> .....                               | <b>4–14</b> |
| <br>  |             |
| <b>Figure 5–1: Error and Event Handling Process Overview</b> .....                        | <b>5–2</b>  |
| <br>  |             |
| <b>Figure B–1: Initial Test Hookup</b> .....  | <b>B–6</b>  |
| <b>Figure B–2: Initial Test Hookup</b> .....  | <b>B–9</b>  |
| <b>Figure B–3: Initial Test Hookup</b> .....  | <b>B–11</b> |
| <b>Figure B–4: Initial Test Hookup</b> .....  | <b>B–19</b> |
| <b>Figure B–5: 1 cycle, <math>\pm 180^\circ</math> phase</b> .....                        | <b>B–22</b> |
| <b>Figure B–6: 1 cycle, <math>0^\circ</math> phase (<math>\pm 360^\circ</math>)</b> ..... | <b>B–22</b> |
| <b>Figure B–7: 1 cycle, <math>+270^\circ</math> phase (<math>-90^\circ</math>)</b> .....  | <b>B–23</b> |
| <b>Figure B–8: 1 cycle, <math>+90^\circ</math> phase (<math>-270^\circ</math>)</b> .....  | <b>B–23</b> |
| <b>Figure B–9: 3 cycle, <math>0^\circ</math> phase (<math>\pm 360</math>)</b> .....       | <b>B–24</b> |
| <b>Figure B–10: 3 cycle, <math>+90^\circ</math> phase (<math>-270</math>)</b> .....       | <b>B–24</b> |
| <b>Figure B–11: 3 cycle, <math>+180^\circ</math> phase (<math>-180</math>)</b> .....      | <b>B–25</b> |
| <b>Figure B–12: 3 cycle, <math>+270^\circ</math> phase (<math>-90</math>)</b> .....       | <b>B–25</b> |
| <b>Figure B–13: Initial Test Hookup</b> .....   | <b>B–27</b> |

## List of Tables

|  |             |
|--|-------------|
| <b>Table 1–1: Power Cord Options</b> .....                               | <b>1–2</b>  |
| <b>Table 1–2: Fuse And Fuse Cap Part Numbers</b> .....                   | <b>1–6</b>  |
| <b>Table 1–3: Instrument Voltage Settings</b> .....                      | <b>1–7</b>  |
| <b>Table 1–4: AC Line Power Requirements</b> .....                       | <b>1–8</b>  |
| <b>Table 1–5: Voltage Ranges and Switch Settings</b> .....               | <b>1–8</b>  |
| <b>Table 1–6: Power Cord Identification</b> .....                        | <b>1–9</b>  |
| <br>   |             |
| <b>Table 2–1: Numeric Value Input Example 1</b> .....                    | <b>2–13</b> |
| <b>Table 2–2: Numeric Value Input Example 2</b> .....                    | <b>2–14</b> |
| <b>Table 2–3: Case 1: Fixed points (one period signal)</b> .....         | <b>2–44</b> |
| <b>Table 2–4: Case 2: Variable points (one period signal)</b> .....      | <b>2–46</b> |
| <b>Table 2–5: Case 3: Fixed points (including M period signal)</b> ..... | <b>2–47</b> |
| <br>   |             |
| <b>Table 3–1: Frequency Setting Range</b> .....                          | <b>3–10</b> |
| <b>Table 3–2: Phase Range</b> .....                                      | <b>3–12</b> |
| <b>Table 3–3: Setting Range for the Frequency Deviation</b> .....        | <b>3–21</b> |
| <b>Table 3–4: Combination of Key Click and Beep</b> .....                | <b>3–33</b> |
| <br>   |             |
| <b>Table 4–1: BNF Symbols and Meanings</b> .....                         | <b>4–5</b>  |
| <b>Table 4–2: Decimal Numeric Notation</b> .....                         | <b>4–9</b>  |
| <b>Table 4–3: Query Responses</b> .....                                  | <b>4–13</b> |
| <b>Table 4–4: CALibration Subsystem Commands</b> .....                   | <b>4–16</b> |
| <b>Table 4–5: FORMat Subsystem Commands</b> .....                        | <b>4–17</b> |
| <b>Table 4–6: INSTRument Subsystem Commands</b> .....                    | <b>4–18</b> |
| <b>Table 4–7: MODE Subsystem Commands</b> .....                          | <b>4–18</b> |
| <b>Table 4–8: OUTPut Subsystem Commands</b> .....                        | <b>4–19</b> |
| <b>Table 4–9: SOURce Subsystem Commands</b> .....                        | <b>4–21</b> |
| <b>Table 4–10: STATus Subsystem Commands</b> .....                       | <b>4–23</b> |
| <b>Table 4–11: SYSTem Subsystem Commands</b> .....                       | <b>4–25</b> |
| <b>Table 4–12: TRACe DATA Subsystem Commands</b> .....                   | <b>4–26</b> |
| <b>Table 4–13: IEEE-488.2 Common Commands</b> .....                      | <b>4–27</b> |
| <br>   |             |
| <b>Table 5–1: SBR Bit Functions</b> .....                                | <b>5–4</b>  |
| <b>Table 5–2: SESR Bit Functions</b> .....                               | <b>5–5</b>  |
| <b>Table 5–3: OCR Bit Functions</b> .....                                | <b>5–6</b>  |
| <b>Table 5–4: QCR Bit Functions</b> .....                                | <b>5–7</b>  |

|   |             |
|---|-------------|
| <b>Table 5–5: Definition of Event Codes</b> .....                   | <b>5–10</b> |
| <b>Table 5–6: Normal Condition</b> .....                            | <b>5–11</b> |
| <b>Table 5–7: Command Errors (CME Bit:5)</b> .....                  | <b>5–11</b> |
| <b>Table 5–8: Execution Errors (EXE Bit:4)</b> .....                | <b>5–12</b> |
| <b>Table 5–9: Internal Device Errors (DDE Bit:3)</b> .....          | <b>5–14</b> |
| <b>Table 5–10: Query Errors (QYE Bit:2)</b> .....                   | <b>5–14</b> |
| <b>Table 5–11: Device Dependent Device Errors (DDE Bit:3)</b> ..... | <b>5–14</b> |
| <b>Table 5–12: Device Dependent Device Errors (DDE Bit:3)</b> ..... | <b>5–15</b> |
| <b>Table 5–13: Device Dependent Device Errors (DDE Bit:3)</b> ..... | <b>5–15</b> |
|   |             |
| <b>Table A–1: Operating Mode</b> .....                              | <b>A–1</b>  |
| <b>Table A–2: Burst Count</b> .....                                 | <b>A–1</b>  |
| <b>Table A–3: Waveforms</b> .....                                   | <b>A–2</b>  |
| <b>Table A–4: Frequency</b> .....                                   | <b>A–2</b>  |
| <b>Table A–5: Amplitude</b> .....                                   | <b>A–2</b>  |
| <b>Table A–6: Offset</b> .....                                      | <b>A–3</b>  |
| <b>Table A–7: Phase</b> .....                                       | <b>A–3</b>  |
| <b>Table A–8: Main Output</b> .....                                 | <b>A–4</b>  |
| <b>Table A–9: Modulation and Sweep</b> .....                        | <b>A–5</b>  |
| <b>Table A–10: Auxiliary Output</b> .....                           | <b>A–5</b>  |
| <b>Table A–11: Auxiliary Input</b> .....                            | <b>A–6</b>  |
| <b>Table A–12: Isolation</b> .....                                  | <b>A–6</b>  |
| <b>Table A–13: Display</b> .....                                    | <b>A–6</b>  |
| <b>Table A–14: AC Line Power</b> .....                              | <b>A–7</b>  |
| <b>Table A–15: Mechanical</b> .....                                 | <b>A–7</b>  |
| <b>Table A–16: Environmental</b> .....                              | <b>A–8</b>  |
| <b>Table A–17: Installation Requirements</b> .....                  | <b>A–8</b>  |
| <b>Table A–18: Certifications and compliances</b> .....             | <b>A–9</b>  |
|   |             |
| <b>Table B–1: Self Test Requirements</b> .....                      | <b>B–2</b>  |
| <b>Table B–2: Calibration Test Requirements</b> .....               | <b>B–3</b>  |
| <b>Table B–3: Test Equipment</b> .....                              | <b>B–5</b>  |
| <b>Table B–4: Output Waveform Test Requirements</b> .....           | <b>B–6</b>  |
| <b>Table B–5: Oscilloscope settings</b> .....                       | <b>B–7</b>  |
| <b>Table B–6: AFG320 Output Waveform</b> .....                      | <b>B–8</b>  |
| <b>Table B–7: Frequency Accuracy Test Requirements</b> .....        | <b>B–9</b>  |
| <b>Table B–8: Amplitude Accuracy Test Requirements</b> .....        | <b>B–11</b> |
| <b>Table B–9: DC Voltage Accuracy Test Requirements</b> .....       | <b>B–16</b> |
| <b>Table B–10: Operating Mode and Phase Test Requirements</b> ..... | <b>B–19</b> |

|  |             |
|--|-------------|
| <b>Table B–11: Oscilloscope settings</b> .....                         | <b>B–19</b> |
| <b>Table B–12: Signal generator settings</b> .....                     | <b>B–21</b> |
| <b>Table B–13: Modulation Function Test Requirements</b> .....         | <b>B–26</b> |
| <b>Table B–14: Oscilloscope settings</b> .....                         | <b>B–27</b> |
| <br>   |             |
| <b>Table C–1: External Inspection Check List</b> .....                 | <b>C–1</b>  |
| <br>   |             |
| <b>Table E–1: Initial Settings</b> .....                               | <b>E–3</b>  |
| <b>Table E–2: Secure Settings</b> .....                                | <b>E–4</b>  |
| <b>Table E–3: Initial Value for the Command Argument</b> .....         | <b>E–5</b>  |
| <b>Table E–4: The Arbitrary Function Generator Character Set</b> ..... | <b>E–6</b>  |
| <b>Table E–5: ASCII and GPIB Code Chart</b> .....                      | <b>E–7</b>  |
| <b>Table E–6: GPIB Interface Function Implementation</b> .....         | <b>E–10</b> |
| <b>Table E–7: GPIB Interface Messages</b> .....                        | <b>E–12</b> |

# General Safety Summary

Review the following safety precautions to avoid injury and prevent damage to this product or any products connected to it. To avoid potential hazards, use this product only as specified.

*Only qualified personnel should perform service procedures.*

While using this product, you may need to access other parts of the system. Read the *General Safety Summary* in other system manuals for warnings and cautions related to operating the system.

## To Avoid Fire or Personal Injury

**Use Proper Power Cord.** Use only the power cord specified for this product and certified for the country of use.

**Use Proper Voltage Setting.** Before applying power, ensure that the line selector is in the proper position for the power source being used.

**Connect and Disconnect Properly.** Do not connect or disconnect probes or test leads while they are connected to a voltage source.

**Ground the Product.** This product is grounded through the grounding conductor of the power cord. To avoid electric shock, the grounding conductor must be connected to earth ground. Before making connections to the input or output terminals of the product, ensure that the product is properly grounded.

**Observe All Terminal Ratings.** To avoid fire or shock hazard, observe all ratings and markings on the product. Consult the product manual for further ratings information before making connections to the product.

Do not apply a potential to any terminal, including the common terminal, that exceeds the maximum rating of that terminal.

**Do Not Operate Without Covers.** Do not operate this product with covers or panels removed.

**Use Proper Fuse.** Use only the fuse type and rating specified for this product.

**Avoid Exposed Circuitry.** Do not touch exposed connections and components when power is present.

**Do Not Operate With Suspected Failures.** If you suspect there is damage to this product, have it inspected by qualified service personnel.

**Do Not Operate in Wet/Damp Conditions.**

**Do Not Operate in an Explosive Atmosphere.**

**Keep Product Surfaces Clean and Dry.**

**Provide Proper Ventilation.** Refer to the manual's installation instructions for details on installing the product so it has proper ventilation.

**Symbols and Terms**

**Terms in this Manual.** These terms may appear in this manual:



---

**WARNING.** *Warning statements identify conditions or practices that could result in injury or loss of life.*

---



---

**CAUTION.** *Caution statements identify conditions or practices that could result in damage to this product or other property.*

---

**Terms on the Product.** These terms may appear on the product:

DANGER indicates an injury hazard immediately accessible as you read the marking.

WARNING indicates an injury hazard not immediately accessible as you read the marking.

CAUTION indicates a hazard to property including the product.

**Symbols on the Product.** The following symbols may appear on the product:



# Preface

This is the user manual for the AFG310 and AFG320 Arbitrary Function Generators.

The *Getting Started* section briefly describes the Arbitrary Function Generators, provides installation instructions, options listing, accessories listing, and power on instructions.

The *Operating Basics* section covers the basic operation principles of the generator. The operating procedures and examples help you understand how your generator operates.

The *Reference* section provides detailed information about the specific functions for each menu.

The *Syntax and Commands* section defines the command syntax and processing conventions, describes command notation, and explains how to connect and set up for a remote operation.

The *Status and Events* section explains the status information and event messages reported by the Arbitrary Function Generators.

The *Appendices* provide specifications, functional check procedures, and other useful information.

## Conventions

In this manual you will find various procedures which contain steps of instructions for you to perform. *Appendix B: Self Test and Calibration Procedure* section uses the following conventions:

- Names appear in the same case (all uppercase) and the same abbreviation as is used on the Arbitrary Function Generator front panel, buttons, and menus.
- Instruction steps are numbered. The number is omitted if there is only one step. Some instruction steps have substeps listed in alphabetical order.
- When steps require that you make a sequence of selections using front panel buttons, an arrow ( → ) marks each transition between front panel buttons:

CH → FUNC → > to display TRIA

Using the convention just described results in instructions that are graphically intuitive and simplifies procedures. For example, the instruction just given replaces these three steps:

1. Press the front panel button CH.
2. Press the front panel button FUNC.
3. Repeatedly press the front panel button > until TRIA is displayed on the LCD (liquid crystal display).

This manual also shows instrument setups using tables. For example, *Operating Basics* section uses tables to show specific setups.

The header of each table contains names of button groups that represent the controls, menus, and items used to set up the instrument. To make a specific setup, read the table from left to right and then from top to bottom as shown below. The table contains the symbol “—” if no action is required.

| Main Button                                      | Control Button Or Numeric Input Key   |  |
|--|---|--|
|  | First Level in the Menu Layers  | Second Level in the Menu Layers  |
| 1. Press Menu or Item Button on the front panel. | 2. Press < or > button several times to display desired item.<br>3. Press ENTER button to confirm your selection. | 4. For the selection, press ^ or v button several times to display desired selection.<br>5. For the numeral, press numeric keys to input value.<br>6. Press ENTER or Unit button to confirm your selection or numeric input. |
| 7  | 8.  | 9.   |
| —  | 10.   | 11.  |
| —  | —   | 12. Press EXIT button to move to upper level in the menu layer.  |
| —  | 13. Press EXIT button to move to default display.   | —  |



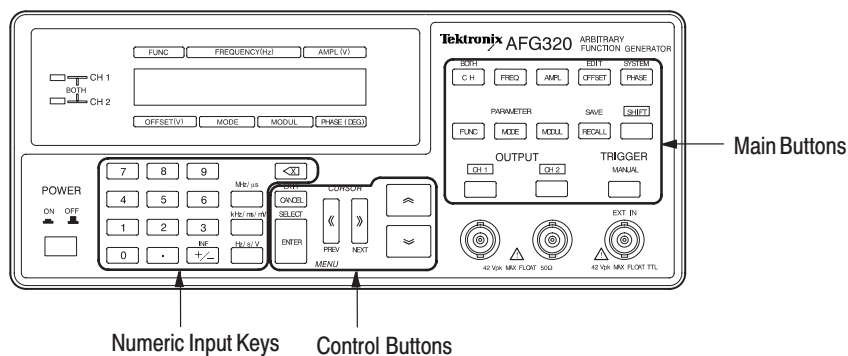

## Default Model

This manual documents the Arbitrary Function Generators. However, the AFG320 display (LCD and channel indicators) appears as the default display wherever a display is illustrated in this manual.

## Contacting Tektronix

|                          |  |
|--------------------------|--|
| <b>Phone</b>             | 1-800-833-9200*  |
| <b>Address</b>           | Tektronix, Inc.<br>Department or name (if known)<br>14200 SW Karl Braun Drive<br>P.O. Box 500<br>Beaverton, OR 97077<br>USA          |
| <b>Web site</b>          | www.tektronix.com  |
| <b>Sales support</b>     | 1-800-833-9200, select option 1*   |
| <b>Service support</b>   | 1-800-833-9200, select option 2*   |
| <b>Technical support</b> | Email: techsupport@tektronix.com<br><br>1-800-833-9200, select option 3*<br>1-503-627-2400<br><br>6:00 a.m. – 5:00 p.m. Pacific time |

\* **This phone number is toll free in North America. After office hours, please leave a voice mail message. Outside North America, contact a Tektronix sales office or distributor; see the Tektronix web site for a list of offices.**



# Getting Started

This section provides the following information:

- Description and features of the Arbitrary Function Generators
- Initial inspection
- Power cord options
- Standard and optional accessories
- Installation procedures
- Repackaging information

## Product Description

The Arbitrary Function Generators are portable waveform generators equipped with both arbitrary waveform editing functions and standard waveform generator functions. The AFG310 Arbitrary Function Generator is a single-channel output model, and the AFG320 Arbitrary Function Generator is two-channel output model.

### Main Features

- Seven types of standard function waveforms:  
Sine, Square, Triangle, Ramp, Pulse, DC, and Noise
- Maximum output frequency is 16 MHz
- 50  $\Omega$  impedance floating output
- Three operating modes:  
Continuous, Triggered, and Burst
- Four types of modulation functions:  
Sweep function, FM modulation, FSK modulation, and AM modulation
- Creating and editing waveforms by edit functions and equipped with four user waveform memories
- 20 setup memories  
Saving and recalling setup in the memory; step recall mode is selectable for recalling
- Standard GPIB interface is:  
You can control the instrument through this interface and import waveforms from other instruments

## Initial Inspection

Inspect the Arbitrary Function Generators carton for external damage. If the carton is damaged, notify the carrier.

Remove the Arbitrary Function Generator from its package and check that it has not been damaged in transit. Verify that the carton contains the basic instrument and its standard accessories. Refer to Accessories on page 1–3.

This instrument was thoroughly inspected for mechanical and electrical defects before shipment. It should be free of scratches and meet or exceed all electrical specifications. To confirm this, inspect the instrument for physical damage incurred in transit and test the electrical performance by following the procedures in *Appendix B: Self Test and Calibration*. Contact your distributor if a discrepancy is found.

---

***NOTE.** Save the shipping carton and packaging materials for repackaging in case shipment becomes necessary.*

---

## Power Cord Options

The following power cords are available with this instrument.

**Table 1–1: Power Cord Options**

| Option | Description              | Tektronix Part Number |
|--------|--------------------------|-----------------------|
| A1     | Europe, 220 V/6A         | 161-0104-06           |
| A2     | United Kingdom, 240 V/6A | 161-0104-07           |
| A3     | Australia, 240 V/6A      | 161-0104-05           |
| A4     | North America, 240 V/6A  | 161-0104-08           |
| A5     | Switzerland, 220 V/6A    | 161-0167-00           |

## Accessories

### Standard Accessories

The Arbitrary Function Generators include the following standard accessories:

| Description  | Part Number |
|--|-------------|
| AFG310 and AFG320 Arbitrary Function Generator User Manual | 071-0175-50 |
| Power Cord 125 V/6A  | 161-0230-01 |

### Optional Accessories

The following optional accessories are recommended for use with the instrument.

| Description   | Part Number |
|---|-------------|
| AFG310 and AFG320 Arbitrary Function Generator Service Manual | 071-0176-50 |
| Wavewriter (Waveform Capture and Editing Software)            | S3FT400     |
| GPIB Cable  | 012-0991-00 |
| 50 $\Omega$ BNC Cable   | 012-1342-00 |
| 50 $\Omega$ BNC Cable (double shielded)                       | 012-1256-00 |
| Rack Mount Kit (EIA)  | 016-1674-00 |

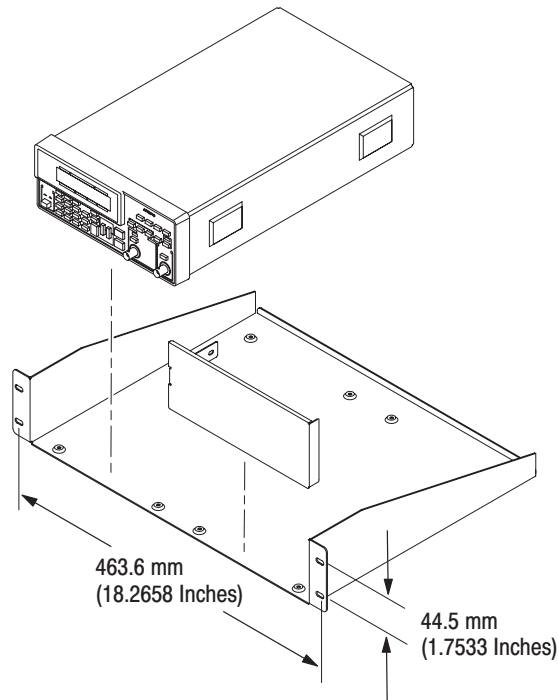

**Figure 1-1: Rack Mount Kit (EIA)**

## Installation

Before you begin, refer to the *General Safety Summary* at the front of this manual for power source, grounding, and other safety information.

### Environment

Verify that you have the correct operating environment.

The instrument operates correctly in ambient temperatures from 0° C to +40° C and relative humidity from 0% to 95% and also in ambient temperatures from 40° C to +50° C and relative humidity from 0% to 75%.



---

**CAUTION.** *Damage to the instrument can occur if this instrument is powered on at temperatures outside the usage temperature range.*

---

For more information on the operating environment, refer to *Appendix A: Specifications*.

### Cooling

The cooling air goes inside from the air intakes at top and goes outside from the rear.

Leave space for cooling. Verify that the air intake holes on the top of the cabinet

and exhaust holes on the rear of the instrument are not obstructed. Allow at least 5 cm (2 inches) of clearance on top and rear.

Leave at least 5 cm(2 inches) free on top when you install the another rack-mounted instrument above the instrument.  
See Figure 1-2.

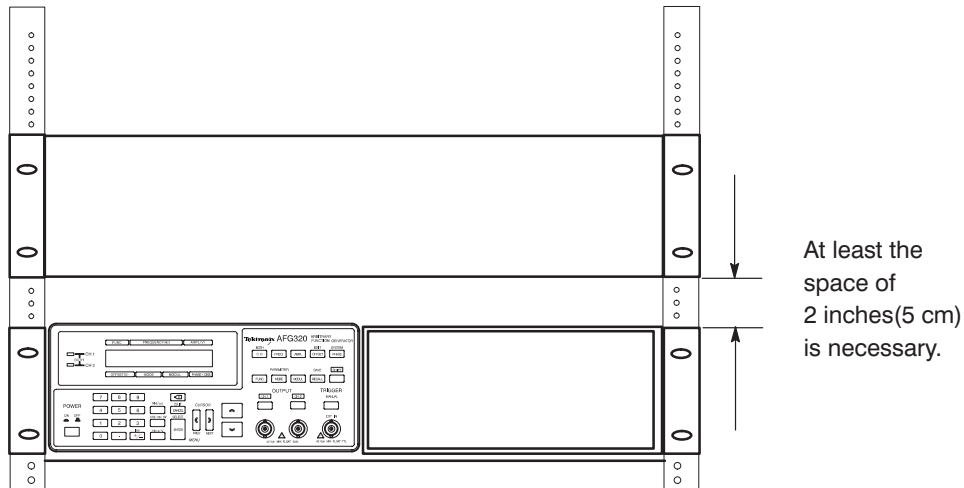

**Figure 1-2: Cooling for rackmounted instrument(s)**

### Installation Set Up

This instrument must be placed in a horizontal position or with the front stand pulled forward until it locks in place. See Figure 1-3.

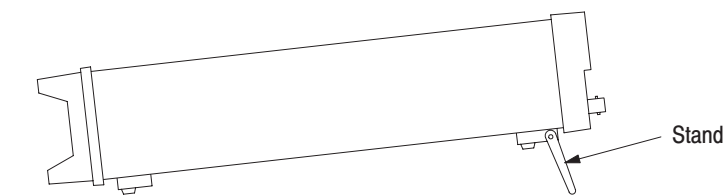

**Figure 1-3: Bench Top Installation**

Install the instrument on a flat, sturdy desk or table.



**CAUTION.** Do not use the instrument standing vertically balanced on its rear panel. This position is unstable and the instrument will be damaged if it falls over.

If you are installing this instrument in a dedicated rack, refer to the instruction sheet that comes with the rack mounting kit.

**Check Fuse**

Check the fuse to be sure it is the proper type and rating.



**WARNING.** To avoid electrical shock, be sure that the power cord is disconnected before checking the fuse.

To remove the fuse, push in and turn the fuse holder cap counterclockwise with a screwdriver. See Figure 1–4 for the fuse location.

The instrument order specified either a UL approved or an IEC approved fuse. Each fuse requires its own cap. See Table 1–2.

**Table 1-2: Fuse And Fuse Cap Part Numbers**

| Fuse   | Tektronix Fuse Part Number | Fuse Cap Part Number |
|--|----------------------------|----------------------|
| 0.25 inch × 1.25 inch (UL 198.6, 3 AG):<br>1 A fast, 250 V | 159-0022-01                | 200-2264-00          |
| 5 mm × 20 mm (IEC 127): 0.5 A (T), 250 V                   | 159-0413\00                | 200-2265-00          |

The fuse approved under the IEC standards is used in equipment sold in the European market.

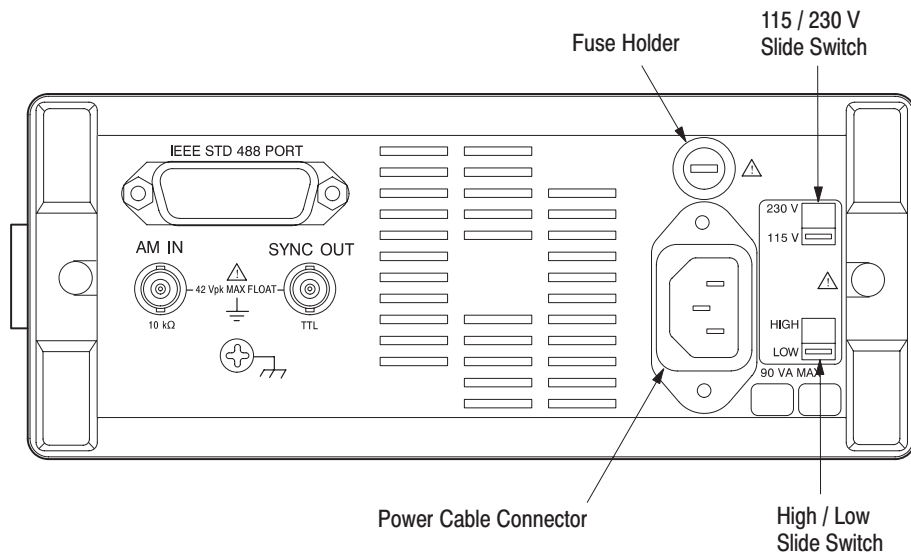

**Figure 1-4: Rear Panel Controls**



**Check Voltage Settings**

Check that you have the proper electrical connections. The instrument requires 90 to 250 VAC<sub>RMS</sub>, 48 Hz to 440 Hz, and may require up to 70 W.

The instrument voltage setting must be adapted to power source voltage. See Table 1–3 for switch settings.

**Table 1–3: Instrument Voltage Settings**

| <b>115/230 Switch</b> | <b>High/Low Switch</b> | <b>Power Source</b> |
|-----------------------|------------------------|---------------------|
| 115 V                 | Low                    | 90 V to 110 V       |
| 115 V                 | High                   | 108 V to 132 V      |
| 230 V                 | Low                    | 180 V to 220 V      |
| 230 V                 | High                   | 216 V to 250 V      |

Table 1–4 contains information for the Arbitrary Function Generators power requirements.

**Table 1–4: AC Line Power Requirements**

















| Name   | Description   |
|--|---|
| Line Frequency Range:<br>48.0 Hz to 63.0 Hz<br>48.0 Hz to 440 Hz | VAC <sub>RMS</sub> :<br>127 V to 250 V<br>90 V to 127 V |
| Maximum Power Consumption  | 70 W  |
| Maximum Current  | 2 A   |



**CAUTION.** To avoid damaging the instrument, be sure that the power cord is disconnected before changing the voltage setting.

Check the voltage settings on the two slide switches on the rear panel. The correspondence between the voltage ranges and the switch settings for those ranges is shown in Table 1–5.

**Table 1–5: Voltage Ranges and Switch Settings**

| Voltage Range                   | 90 V ~ 110 V   | 108 V ~ 132 V  | 180 V ~ 220 V  | 216 V ~ 250 V  |
|---------------------------------|--|--|--|--|
| 115 V / 230 V<br>Voltage Switch | 230 V <br>115 V  | 230 V <br>115 V  | 230 V <br>115 V  | 230 V <br>115 V  |
| High / Low<br>Range Switch      | High <br>Low     | High <br>Low     | High <br>Low     | High <br>Low     |

**Connect Cable**

Connect the proper power cord from the rear panel power connector to the power system. See Table 1–6.



**CAUTION.** The instrument is shipped with a power cord appropriate for use with your power systems (normal 115 V power system or 230 V power system). If the instrument is to be used with a power system other than what the order specified, the power cord must be replaced with one appropriate for the power source used. See Power Cord Options in this section, for the available power cord types.

**Table 1-6: Power Cord Identification**

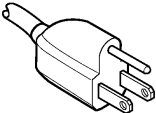
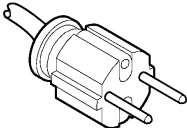
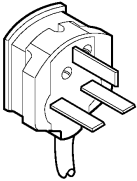
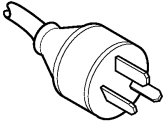
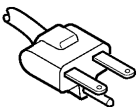
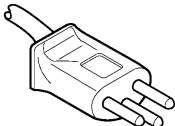
| Plug configuration  | Normal usage            | Option number |
|---|-------------------------|---------------|
|    | North America<br>125 V  | Standard      |
|    | Europe<br>230 V         | A1            |
|    | United Kingdom<br>230 V | A2            |
|   | Australia<br>230 V      | A3            |
|  | North America<br>230 V  | A4            |
|  | Switzerland<br>230 V    | A5            |

**Power On** The LCD display is blank when the instrument is turned off. Push the front panel switch labeled POWER to power on the instrument. See Figure 1-5.

Make sure that the fan is turning.

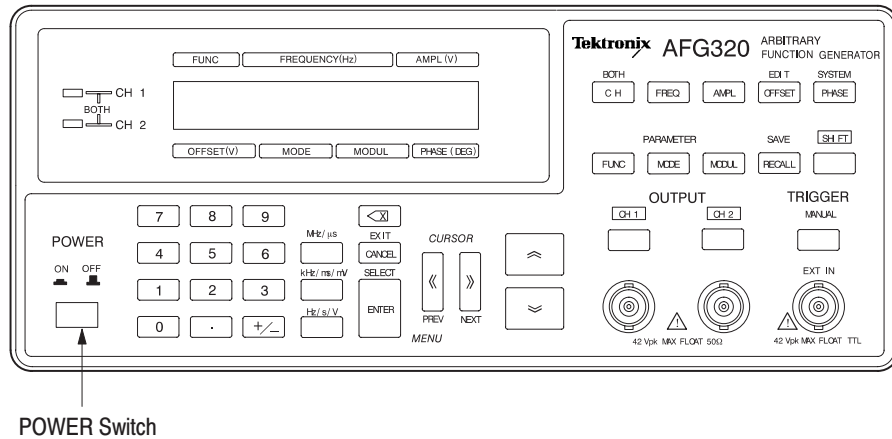

Figure 1-5: POWER Switch

**Self Test**

Check the results of the startup self test.

Power-on tests occur automatically each time you power on the instrument. See Figure 1-6 for the LCD display.

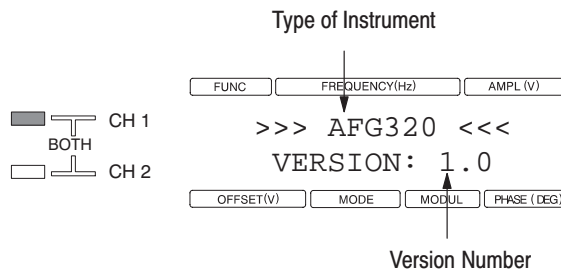

Figure 1-6: The LCD Display at Power On

The system continues to the default display after the start-up tests are complete.

---

**NOTE.** Allow a 20-minute warm-up for the instrument to operate at its optimum precision.

---

If an error is detected (see Figure 1-7), an error message is displayed on the first line, and the test item is displayed on the second line. When multiple errors are detected, use the  $\vee$  and  $\wedge$  buttons to scroll through the failed test items. Although you can clear the error display state and use the instrument, waveform output will not be reliable until you resolve the errors.

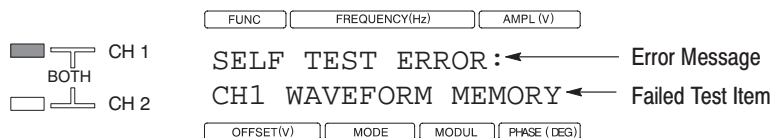

**Figure 1-7: The LCD Display When Error is Found**

To exit the error display, press the CANCEL/EXIT button.

If the self test fails, contact your distributor about details of warranty and service.

---

**NOTE.** The power-on self test consists of a subset of the tests performed by the SYSTEM menu SELF TEST item. Instrument calibration is not performed at power on unless an error is found in the internally stored calibration data. Use the SYSTEM menu self test and calibration items for more thorough self testing and calibration.

This instrument uses flash memory as its internal nonvolatile memory. After this memory has been written about 1000 times, the instrument rewrites the whole chip. This provides wear leveling (distributed writing and periodic deletion/re-writing). This operation causes the time required between power on and the point the instrument can be used to be about ten seconds longer than usual.

---

**Power Off** To power off the instrument, press the POWER switch.

---

**NOTE.** The instruments current settings are not automatically stored at power off. To store instrument settings for the next power on, use the SAVE menu before powering off.

---

## Repackaging for Shipment

If this instrument is shipped by commercial transportation, use the original packaging material. If the original packaging is unfit for use or is not available, repackage the instrument as follows:

1. Obtain a corrugated cardboard shipping carton having inside dimensions at least six inches greater than the instrument dimensions and having a carton test strength of at least 124.74 kg (275 pounds).
2. If the instrument is being shipped to a Tektronix Service Center for repair or calibration, attach a tag to the instrument showing the following: owner of the instrument (with address), the name of a person at your firm who may be contacted if additional information is needed, complete instrument type and serial number, and a description of the service required.
3. Wrap the instrument with polyethylene sheeting or equivalent to protect the outside finish and prevent entry of packing materials into the instrument.
4. Cushion the instrument on all sides by tightly packing dunnage or urethane foam between the carton and the instrument, allowing for three inches of padding on each side (including top and bottom).
5. Seal the carton with shipping tape or with an industrial stapler.
6. Mark the address of the Tektronix Service Center and your return address on the carton in one or more prominent locations.

# Operating Basics

This section provides the following information:

- Provides an overview of the instrument controls and their functions
- Provides an LCD display example
- Describes basic operating procedures grouped by function
- Explains how to enter numbers
- Explains how to output a waveform
- Explains how to edit, save, and input waveforms
- Describes the terminology and content of representative screen displays
- Provides tutorials covering basic procedures for waveform output and basic settings on the AFG320

## Controls and Connectors

**Front Panel** Figure 2–1 shows the locations of the front-panel controls and connectors.

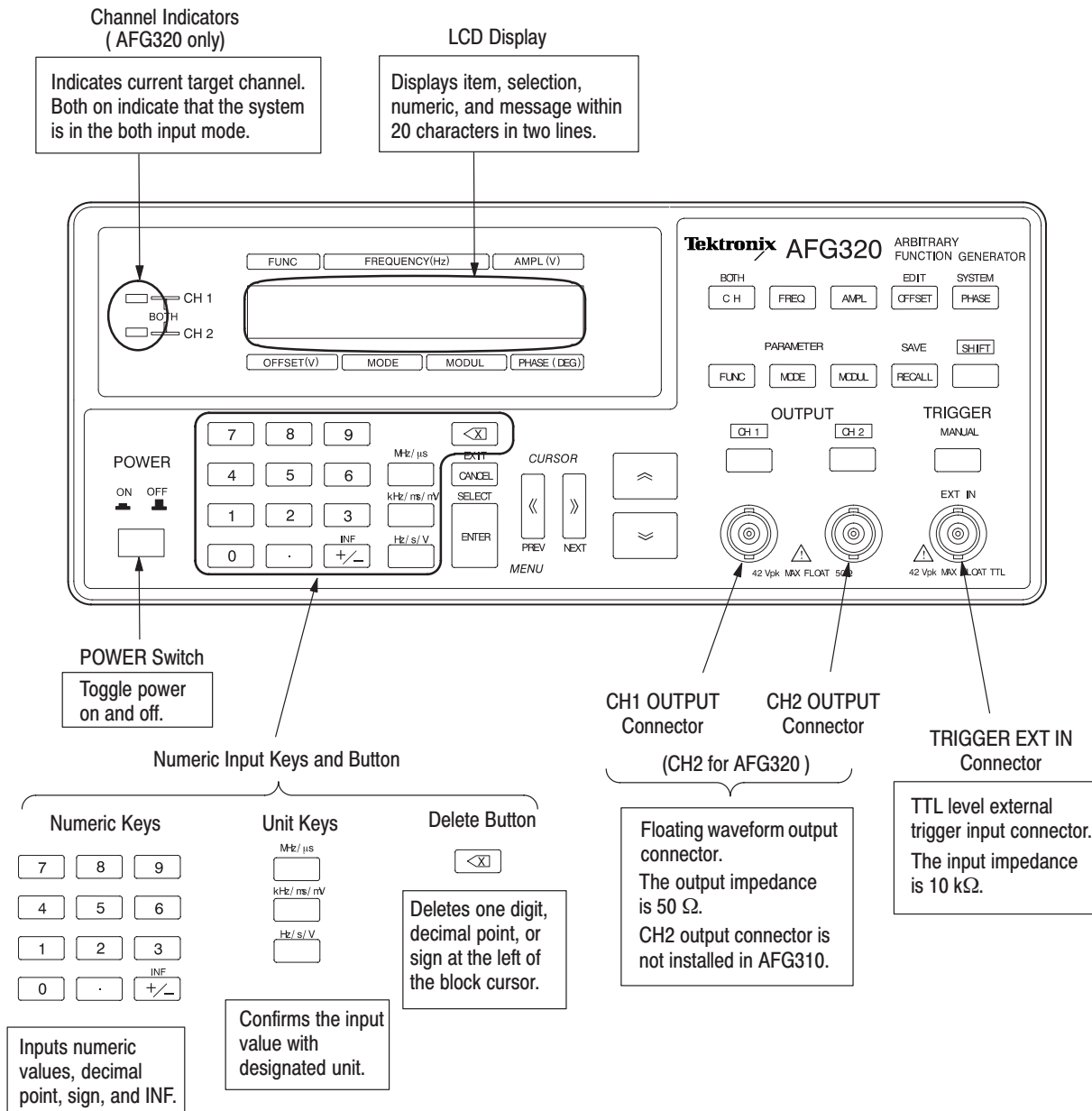

**Figure 2–1: Front Panel Controls**



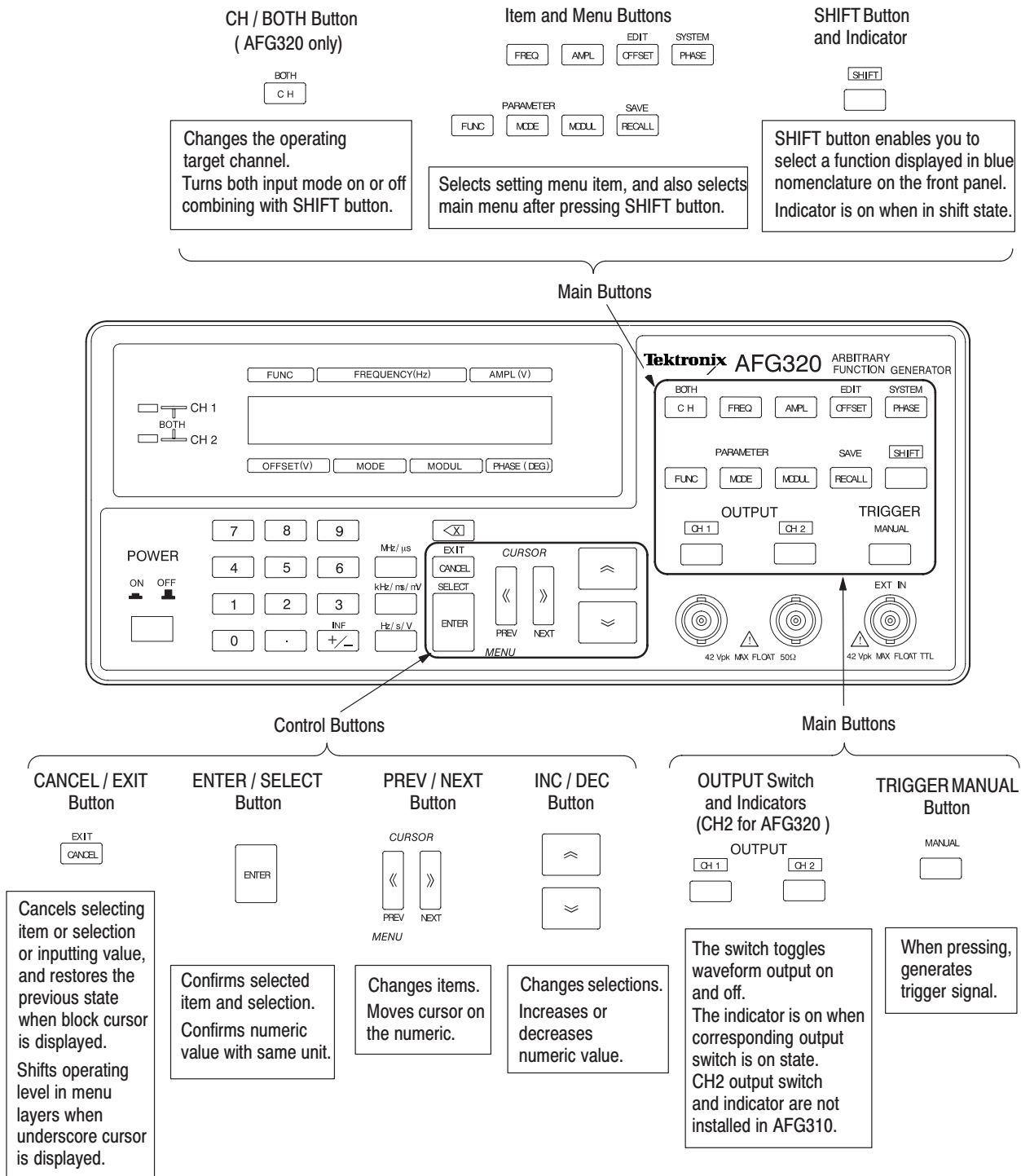
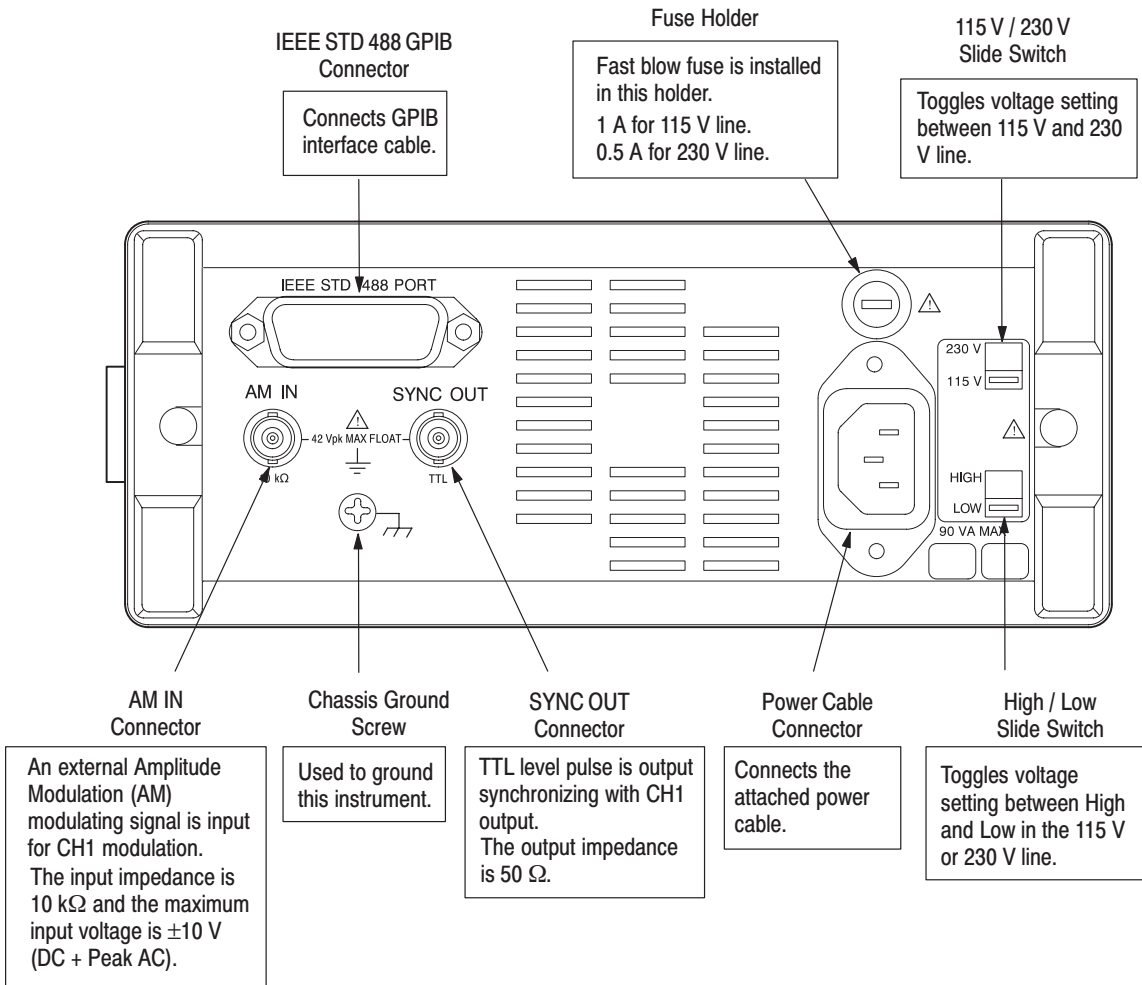

Figure 2-1 : Front Panel Controls (cont.)

**Rear Panel** Figure 2–2 shows the rear panel controls and connectors.



**Figure 2–2: Rear Panel**

## Input and Output Connectors

This instrument provides an OUTPUT, SYNC OUT, TRIGGER EXT IN, and AM IN connector. These are floating outputs or floating inputs. The note “42 VpkMAX FLOAT” appears on the panel adjacent to each of these connectors to indicate that they are floating connections. For examples of floating connections, refer to Appendix D: Floating Connections.



---

**WARNING.** To prevent electrical shocks, do not apply voltages in excess of 42 Vpk to any BNC connector ground or to the chassis ground.

All BNC commons must be at the same potential.

---

**OUTPUT Connector.** The output connector outputs the waveforms generated by the instrument. The AFG310 provides a CH1 connector and the AFG320 provides a CH1 and a CH2 connector.

- The output impedance is 50  $\Omega$ . The voltage displayed on the LCD is the voltage output when a 50  $\Omega$  termination is provided. When the output is open, a voltage twice that displayed on the LCD is output from the OUTPUT connector(s).



---

**CAUTION.** To prevent damage to the instrument, do not short output pins or apply external voltages could result.

---

**SYNC OUT Connector.** This connector outputs a TTL level pulse synchronized with the CH1 output. See *Appendix D: Sync Signal Output* on page E-1, for details on signal output timing.

- The output impedance is 50  $\Omega$ .



---

**CAUTION.** Do not short output pins or apply external voltages. Damage to the instrument could result.

---

**TRIGGER EXT IN Connector.** The EXT IN connector inputs a TTL level external trigger signal.

- The input impedance is 10 k $\Omega$ .



---

**CAUTION.** Do not apply excessive inputs over +5 V. Damage to the instrument could result.

---

**AM IN Connector.** The AM IN connector inputs an external AM modulation signal. See page 3–17, *AM (AM) Modulation*, for details on input level and modulation depth.

- The input impedance is 10 k $\Omega$ .



---

**CAUTION.** Do not apply excessive inputs over  $\pm 5$  V. Damage to the instrument could result.

---

## Basic Menu Operations

*Basic Menu Operations* contains the following information:

- Reading an LCD display
- Moving between menus
- Entering Numeric input
- Outputting a waveform
- Setting the waveform parameters
- Setting the operation mode
- Applying modulation/sweep to the output waveform
- Recalling a setting
- Saving setups
- Editing, saving, and importing waveforms
- Setting the instrument system

## LCD Display

The LCD (liquid crystal display), shows the Default Display or the Menu Item Display. Refer to Figure 2–1 for the location of the LCD Display on the front panel. For an example of the Default Display, refer to Figure 2–3. For an example of the Menu Item Display, refer to Figure 2–4.

**Default Display.** In this state, the current CH1 values for the setting menu items (FUNC, FREQ, AMPL, OFFSET, MODUL, MODE, and PHASE) are displayed.

The instrument goes to the default display state after power on, after executing the initialization procedure, and after executing the secure operation.

Press the EXIT (CANCEL) button repeatedly to return to the default display from states in which menu items are displayed. Also, pressing any one of the OFFSET, MODE, MODUL, or PHASE buttons returns to the default display.

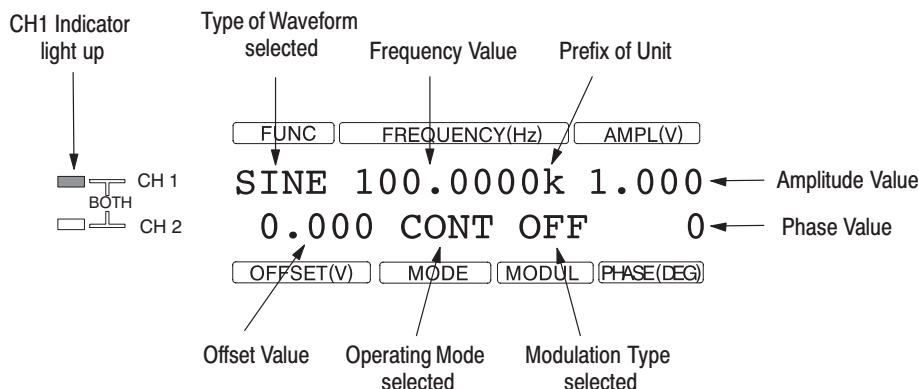

**Figure 2–3: Default Display**

**Menu Item Display.** When the SHIFT button and then one of the EDIT, SYSTEM, FUNC PARAMETER, MODE PARAMETER, MODUL PARAMETER, or RECALL buttons are pressed sequentially, or when the SAVE button is pressed, the corresponding menu item will be displayed in the second line of the LCD. The display example shown below occurs when the FUNC PARAMETER menu has been selected.

In some cases the FUNC PARAMETER, MODE PARAMETER, or MODUL PARAMETER, shown in the second line of the LCD, is not a valid parameter for the FUNC displayed in the first line of the LCD. For example, the FUNC PARAMETER Pulse Duty has no effect on the FUNC SINE as displayed in Figure 2–4.

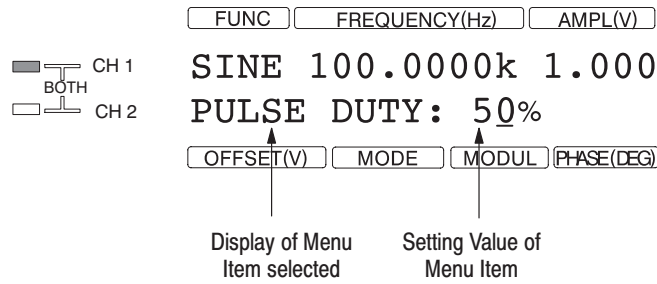
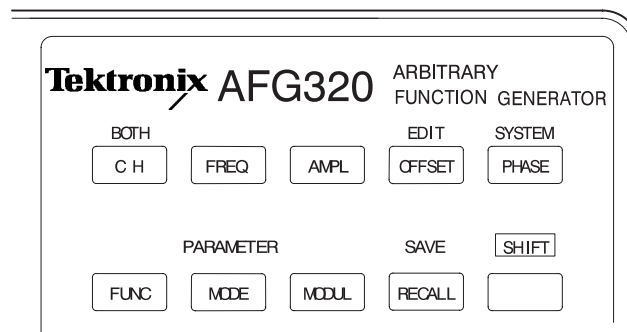

**Figure 2-4: Menu Item Display**

**Moving Between Menus**

The buttons used for selecting main menus and items from the setting menu are located in the upper right of the front panel. Refer to Figure 2-5.

- Item buttons in the Setting menu (seven items)  
**FREQ, AMPL, OFFSET, PHASE, FUNC, MODE, MODUL**
- Main menu buttons (seven types)  
**EDIT, SYSTEM, FUNC-PARAMETER, MODE-PARAMETER, MODUL-PARAMETER, RECALL, SAVE**



**Figure 2-5: Item Buttons and Main Menu Buttons**

**Operation for Setting the Menu Items.** Follow the steps below for setting the menu items:

1. Select the desired item using the front panel item buttons.

Depending on the item selected, the underscore cursor will be displayed at either numeric value or at selection on the LCD display.

2. Enter the numeric value, or make the selection.
  - Numeric values can be changed with the  $\wedge$  and  $\vee$  buttons. Alternatively, the value can be entered with the numeric keys and confirmed by pressing a unit key or the ENTER button.
  - Use the  $\wedge$  and  $\vee$  buttons to change a selection. Confirm the selection with the ENTER button.

Prior to confirmation (when the block cursor is blinking), numeric values and selections can be restored to their original states by pressing the CANCEL button.

**Operation for the Main Menus.** Follow the steps below for main menu operation:

1. Select the desired menu using the front panel menu buttons.

One of the items included in the selected menu will appear to the left of the colon in the second row on the LCD screen, and one numeric value or selection for that item is displayed to the right of the colon. See Figure 2–6.

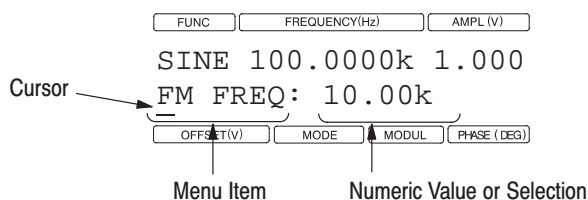

**Figure 2–6: Display Example for a Main Menu Selected**

The underscore cursor will appear either in the item to the left of the colon or in the selection area or numerical value to the right of the colon. For menus with only one item, the cursor will be displayed immediately at the selection or numeric value.

The procedure from this point will depend on whether the cursor is displayed to the left or right of the colon:

- If the cursor is displayed on the item (to the left of the colon), proceed to Step 2.
- If the cursor is displayed in the selection area or number (to the right of the colon), proceed to Step 3, or press the EXIT (CANCEL) button to go to the item selection level and then proceed to Step 2.

2. Use the < and > buttons to change items until the desired item is displayed. Then confirm the selected item with the ENTER button.

The cursor moves to selection or numeric value to the right of the colon.

3. Enter the numeric value, or make the selection.
  - Numeric values can be changed with the ^ and v buttons. Alternatively, the value can be entered with the numeric keys and confirmed by pressing a unit key or the ENTER button.
  - Use the ^ and v buttons to change a selection. Then confirm the selection with the ENTER button.

Prior to confirmation (when the block cursor is blinking), numeric values and selections can be restored to their original states by pressing the CANCEL button.

4. Press the EXIT (CANCEL) button to switch to the higher level (to the item selection level) and to make it possible to repeat Steps 2 through 4.

It is possible to select another menu or setting item at any time while the underscore cursor is displayed. When a menu is selected, the same item and its selection will be displayed with same cursor location as they were the last time that menu was selected.

Each time the EXIT (CANCEL) button is pressed, the system switches to the next higher level, and finally returns to the default display. In addition to the EXIT (CANCEL) button, the OFFSET, PHASE, MODE, and MODUL buttons can also be used to return to the default display.

### Numeric Input

An underscore is displayed at one of the digits in the numeric value on the LCD display when numeric input is required. See Figure 2-7.

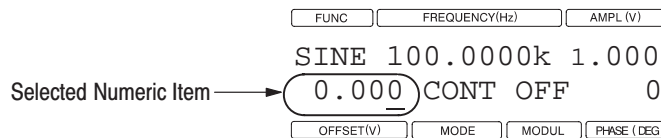

**Figure 2-7: Display Example for a Numeric Item Selected**

The numeric keys and control buttons are used for numeric input. The following describes the techniques for entering numeric values.



**Using the Numeric Buttons.** Follow the steps below to input numeric values.

Use the buttons and keys, shown in Figure 2–8, to input numeric values with the numeric keys.

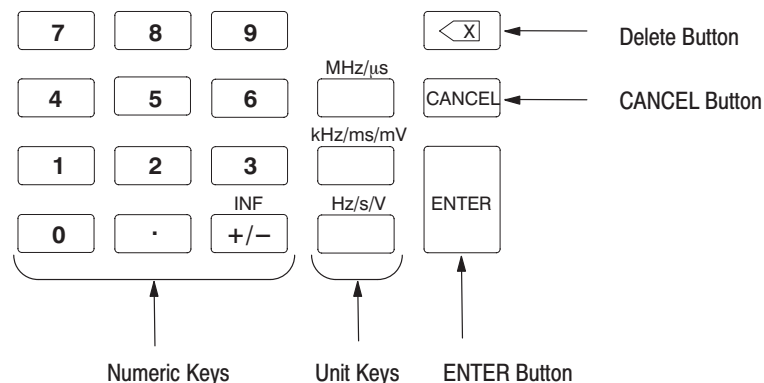

**Figure 2–8: Buttons and Keys for Inputting Numeric Value**

1. Input the target value using the numeric keys.

Figure 2–9 shows the input of the value –1.0. When the numeric keys are used for input, a block cursor is displayed as shown in the figure.

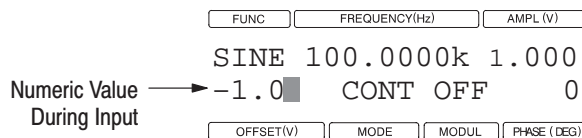

**Figure 2–9: Example for Inputting Numeric Value**

Use either the delete key or the CANCEL button to correct an input.

- **Delete Button.** This button deletes one digit, decimal point, or the +/- character to the left of the block cursor. If the delete button is pressed and held down; the delete operation is repeated.
- **CANCEL Button.** The value input is cancelled, and the original value is redisplayed.

2. The input numeric value is confirmed by pressing a unit key or the ENTER button.

---

**NOTE.** The +/- character can be input at any point prior to confirming the numeric value for numeric items that allow a negative value.

If a value outside the valid range for a numeric item is entered, the value will be replaced by the smallest or largest value in that range when the value is confirmed. If a value is entered to greater precision than the resolution of the numeric item, the value will be rounded off when confirmed.

---

**Using the Control Buttons.** Follow the steps below to change the numeric value.

Use the buttons shown in Figure 2–10 to change numeric values.

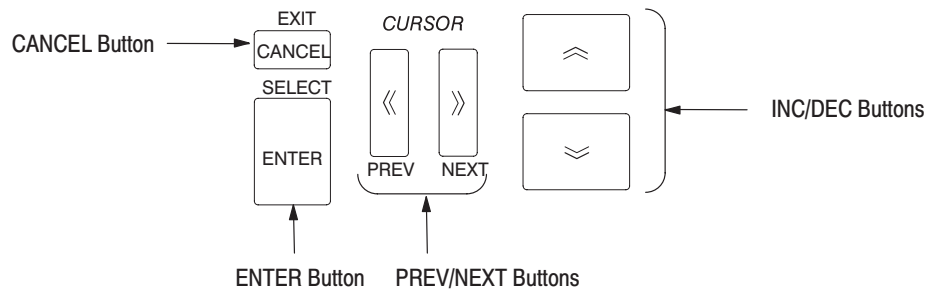

**Figure 2-10: Buttons for Changing Numeric Value**

1. Place the cursor on the digit that will be changed by pressing the < or > button.
2. Use the ^ and v buttons to change the numeric value.

Use the CANCEL button to correct an input. Note that this operation is valid when the block cursor is displayed. The CANCEL button cancels the input value and redisplay the original value.

If the cursor is placed on the highest digit and the digit is reduced to 1, the value will not change if the v button is pressed again. At this point the value can be reduced by moving the cursor to the next lower digit. Amplitude and offset values are the exception.

- Amplitude. The value to the left starting at the position of the cursor can be reduced to 1 (in the case of values like 1.030 and 0.120) or 0 (in the case of values like 0.235 and 0.080). Then pressing the v button reduces the value to the minimum value of 0.050.

- Offset. If the current offset value is positive, pressing the  $\vee$  button reduces the value to the left starting at the position of the cursor to 0. Pressing this button again reduces the value in the minus region. If the current offset value is negative, pressing the  $\wedge$  button increases the value across 0 as well.

Phase values can be negative as well. However, to change the value above or below zero, the cursor must be moved temporarily to the least significant digit.

3. After a value has been changed, the value can be confirmed by pressing a unit key or the ENTER button if the block cursor is blinking.

When a value has been changed, some items require that the front panel ENTER button be pressed. If an underscore cursor is displayed after a value has been changed, that item is already confirmed. If the block cursor is blinking after the value has been changed, either a unit key or the ENTER button must be pressed to confirm that value. See Tables 2-1 and 2-2.

When the underscore cursor is displayed, it is not necessary to press the ENTER button.

The numeric values for the **FREQ**, **AMPL**, **OFFSET**, and **PHASE** items in the setting menu have the characteristics of the numeric values in setting Example 1.

**Table 2-1: Numeric Value Input Example 1**

| Buttons for Input | LCD Display | Numeric Value Status |
|-------------------|-------------|----------------------|
|                   | 1.00<br>_   | Before input         |
| >                 | 1.00<br>_   | During input         |
| $\vee$            | 0.90<br>_   |                      |
| $\vee$            | 0.80<br>_   | Entered              |

When the underscore cursor has changed to the block cursor, either a unit key or the ENTER button must be pressed to confirm the value. If a unit key or the ENTER button is not pressed, the value will revert to the previously set value after exiting from the menu.

The numeric values for other than the **FREQ**, **AMPL**, **OFFSET**, and **PHASE** items in the setting menu have the characteristics of the numeric values in setting Example 2.

**Table 2-2: Numeric Value Input Example 2**

| Buttons for Input | LCD Display | Numeric Value Status |
|-------------------|-------------|----------------------|
|                   | 121.0 k     | Before input         |
| <                 | 121.0 k     | During input         |
| ∨                 | 120.0 k     |                      |
| <                 | 120.0 k     |                      |
| ∨                 | 110.0 k     |                      |
| ∨                 | 100.0 k     |                      |
| ∨                 | 90.00 k     |                      |
| ENTER             | 90.00 k     | Entered              |

**Outputting the Waveform**

Follow the steps below to output a waveform:

1. Connect an oscilloscope to the Arbitrary Function Generator to observe the output waveform.
2. Select a target channel for operation.

The settings can be set for each channel independently. Select the desired channel before setting each item.

The CH indicator displays the selected channel. Press the CH button to change the channel.

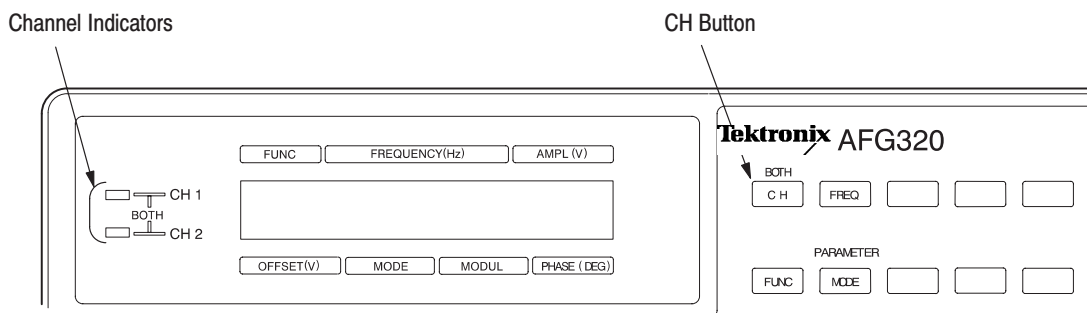

**Figure 2-11: CH Button and Channel Indicators**

3. Select one of the standard waveforms.
  - a. Press the FUNC button on the front panel.

- b. Use the  $\wedge$  and  $\vee$  buttons to scroll through the waveform names until the desired standard waveform is displayed in the LCD.
  - c. Press the ENTER button to confirm the selected waveform.
4. Press the OUTPUT switch to start the waveform output.

The OUTPUT switch opens and closes the line that connects the instruments internal output circuit to the output connector. When this switch is on a waveform corresponding to the currently set output mode (continuous, triggered, or burst mode), the waveform will be output from the OUTPUT connector.

### Setting Waveform Parameters

The following procedure provides information on setting waveform parameters.

**Frequency, Amplitude, Offset, Phase.** Follow the steps below to set the parameters (frequency, amplitude, offset, and phase):

1. Press the FREQ, AMPL, OFFSET, or PHASE button according to the parameter type to be set.
2. Input the target value using the numeric keys or control buttons.

**Setting the Both Input Mode** Follow the steps below to set the BOTH input mode.

---

**NOTE.** *The BOTH input mode is available for the AFG320 only.*

---

1. Press the FREQ, AMPL, OFFSET, or PHASE button according to the parameter type to be set.
2. Press the SHIFT button, and then press the CH button.

At this point the value of the selected parameter for both CH1 and CH2 will be changed to the value currently displayed. However, if the channel that is not displayed exceeds the maximum value, both channels will be set to that maximum value.

3. Input the target value using the numeric keys or control buttons.

**Cancel the Both Input Mode.** Follow the steps below to cancel the Both input mode.

1. Press the parameter item button for which BOTH input has been set.
2. Press the SHIFT button, and then press the CH button.

**Duty.** Follow the steps below to change the duty of the standard function pulse waveform:

1. Press the SHIFT button and then press the FUNC button.

This will result in the following display.

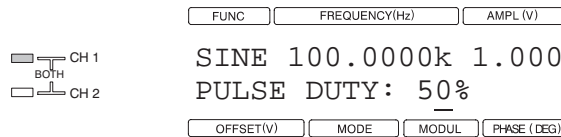

2. Change the duty value using the numeric keys or control buttons.
3. Press the ENTER button to confirm the changed value.

## Setting Operation Mode

The following procedures provide information on setting operation mode.

**Selecting the Operation Mode.** Follow the steps below to select the operation mode:

1. Press the MODE button on the front panel.
2. Use the  $\wedge$  and  $\vee$  buttons to scroll through the mode names until the desired mode is displayed in the LCD.
3. Press the ENTER button to confirm the selected mode.

**Burst Count.** The burst count is only valid when burst mode has been selected. The burst count can be input at any time.

Follow the steps below to change the burst count:

1. Press the SHIFT button and then press the MODE button.

This will result in the following display.



2. Change the burst count.

The burst count can be set to an arbitrary value from 1 to 60,000 or to infinity.

To set a numeric value, change the value using the numeric keys or the control buttons, and then press the ENTER button.

To set an unlimited number of counts, press the SHIFT button, and then press the INF (+/-) key.

### Apply Modulation/Sweep to the Output Waveform

The following procedures provide information on modulation/sweep to the output waveform.

**Selecting Modulation/Sweep.** Follow the steps below to select Modulation/Sweep:

1. Press the MODUL button on the front panel.
2. Use the ^ and v buttons to scroll through the modulation/sweep names until the desired modulation/sweep is displayed in the LCD.
3. Press the ENTER button to confirm the selected modulation/sweep.

**Modify Modulation/Sweep.** Follow the steps below to modify Modulation/Sweep:

1. Press the SHIFT button and then press the MODUL button.

This will result in the following display.



The sweep, FM modulation, and FSK modulation can be customized.

2. Select a target parameter of the sweep or modulation for customizing using the ^ and v buttons to scroll through the modulation/sweep parameter names until the desired parameter name is displayed in the LCD.
3. Press the ENTER button to confirm the selected parameter.
4. Enter the numeric value or make the selection.

Parameters are either set to a numeric value or selected from a set of selections.

Follow the steps below to select a parameter selection:

5. Use the ^ and v buttons to scroll through the set of selections until the desired selection is displayed in the LCD.
6. Press the ENTER button to confirm the selection.

Follow the steps below to input numeric values:

7. Change the value using the numeric keys or control buttons.
8. Press the ENTER button or unit key to confirm the numeric value.

## **Recall a Setting**

The following procedures provide information on recalling a setting.

**Recall by Designating Memory Number.** Follow the steps below to recall by designating Memory Number:

1. Press the RECALL button on the front panel.
2. Use the  $\wedge$  and  $\vee$  buttons to scroll through the memory numbers until the desired Memory Number is displayed in the LCD.
3. Press the ENTER button to confirm the selected number.

**Recall by the Step Recall.** Follow the steps below to recall by using Step Recall:

1. Set the step recall mode to ON state in the SYSTEM menu.
2. Set the value for the LAST RECALL STEP in the SYSTEM menu.

This value is the last setting memory number recalled.

Once the STEP RECALL and LAST RECALL STEP items have been set, there is no need to perform Steps 1 and 2 in this procedure again. Since these settings are stored in nonvolatile memory, they are not reset when the power is turned on or off or when the instrument is initialized.

3. Press the RECALL button on the front panel.
4. Use the  $\wedge$  and  $\vee$  buttons to scroll through the memory numbers until the memory number to be recalled first is displayed in the LCD.
5. Press the ENTER button to confirm the selected number.

The setup for the displayed memory number can be recalled by pressing the ENTER button. At the same time, the displayed memory number will be increased.



---

**NOTE.** In step 4 if you selected a memory number that was equal to or greater than the value of the *LAST RECALL STEP*, the following actions occur when you press *ENTER*:

- The selected memory number is recalled.
  - The memory number is then referred to zero.
- 

6. To intermit recall under step recall mode, exit from the *RECALL* menu with the *EXIT (CANCEL)* button. The instrument will return to the default display.

In addition to the *EXIT (CANCEL)* button, the *OFFSET*, *PHASE*, *MODE*, and *MODUL* buttons also can be used to return to default display.

### Saving a Setup

Follow the steps below to save a setup:

1. Press the *SHIFT* button and then press the *RECALL* button to access the save mode.

---

**NOTE.** Pressing the shift button enables you to select a function displayed in blue nomenclature on the front panel. The indicator is on when in shift state.

---

2. Use the  $\wedge$  and  $\vee$  buttons to scroll through the memory numbers until the memory number in which the current settings are saved is displayed in the LCD.
3. Press the *ENTER* button to execute the save function.

### Sample Waveforms

The sample waveforms are saved in user waveform memory from *USER1* to *USER4* when this instrument is shipped from the factory. To output these sample waveforms, select the user waveform memory name with the *FUNC* item. There are four sample waveforms as follows:

- *USR1*: Sampling Function  $\text{SIN}(x)/x$  Pulse
- *USR2*: Double Exponential Pulse
- *USR3*: Damped Sine Wave
- *USR4*: NRZ Random Signal

When a save operation is executed to the user waveform memory, the previous contents are overwritten. The sample waveforms can be restored by executing the *SECURE* function in the *SYSTEM* menu.

**NOTE.** When the SECURE function is executed, the data stored in nonvolatile memory (user waveform memory and setting memory) is initialized, and restores the instrument to the factory settings.

**Sampling Function SIN(X)/X Pulse.** The settings of the Sampling Function are as follows:

|                           |  |
|---------------------------|--|
| Number of Points:         | 1600                                       |
| Peak Location:            | 800th point                                |
| Maximum Output Frequency: | 10 kHz                                     |
|                           | 40 oscillations in one period of the pulse |

Refer to Figure 2–12 for an example of Sin(X)/X Pulse.

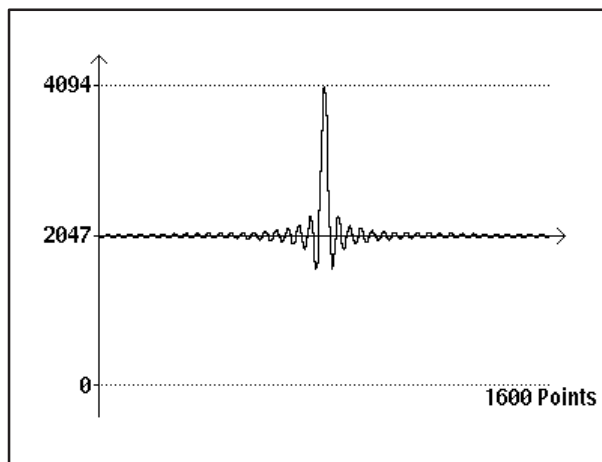
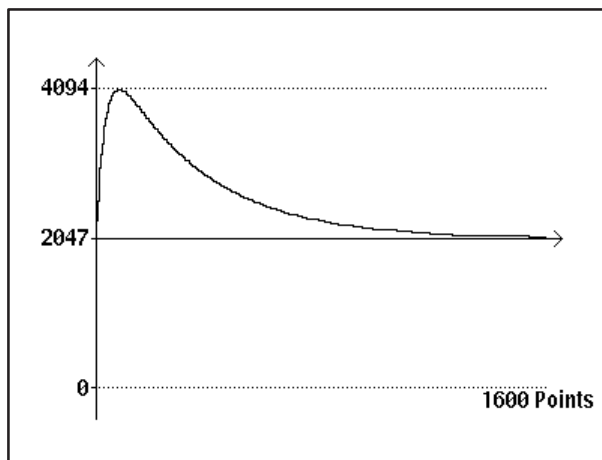

**Figure 2–12: Sin(X)/X Pulse**

**Double Exponential Pulse.** The settings of the double exponential pulse are as follows:

|                           |  |
|---------------------------|--|
| Number of Points:         | 1600   |
| Ratio of Time Constant:   | $\tau_2 = 10 \tau_1$<br>(rise time constant: $\tau_1$ , fall time constant: $\tau_2$ ) |
| Peak Location:            | 82th point   |
| Maximum Output Frequency: | 10 kHz   |

Refer to Figure 2–13 for an example of the rising and falling double exponential function pulse.

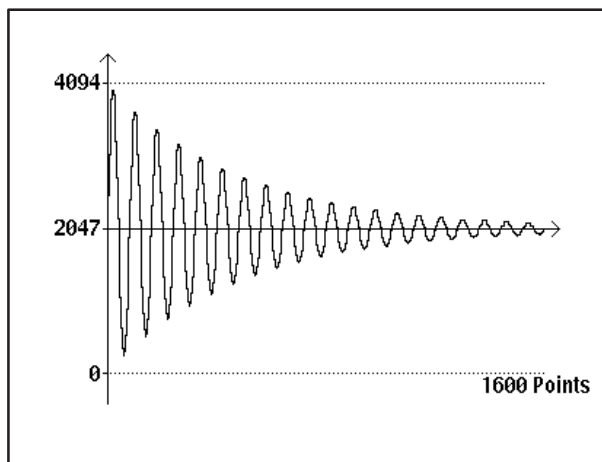

**Figure 2–13: Double Exponential Pulse**

**Damped Sine Wave.** The settings of damped sine wave are as follows:

Number of Points: 1600  
 Maximum Output Frequency: 10 kHz

Refer to Figure 2–14 for an example of the rising and falling damped sine wave.



**Figure 2–14: Damped Sine Wave**

**NRZ Random Signal.** This is a m-series, pseudo-random signal generated with the shift register shown in Figure 2–15.

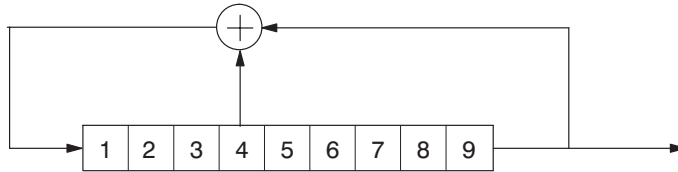
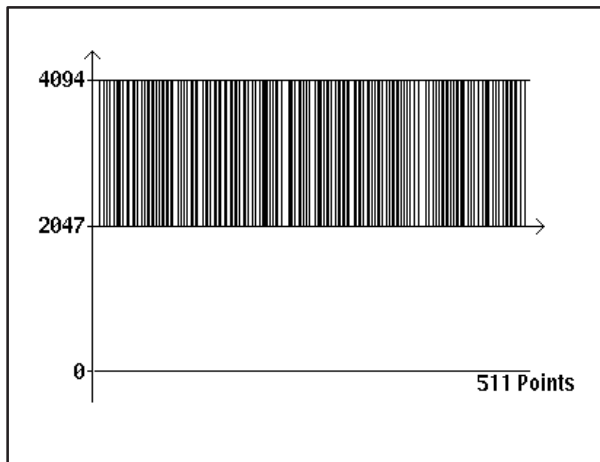

**Figure 2–15: Pseudo-random Signals Generated with Shift Register**

The shift register bits are initially set to 1 and the data is changed every two samples. The one sequence of m-series pseudo-random signal consists of  $(2^9 - 1) \times 2$  points. The settings of register are as follows:

|                           |              |
|---------------------------|--------------|
| Register Length:          | 9            |
| Points/Step:              | 1            |
| Coding:                   | NRZ          |
| Number of Points:         | 511          |
| Maximum Output Frequency: | 31.31115 kHz |

Refer to Figure 2–16 for an example of the NRZ random signal.



**Figure 2–16: NRZ Random Signal**

## Editing, Saving, and Importing Waveforms

The following procedures provide information on editing, saving, and importing waveforms.

**Editing a Waveform.** Follow the steps below to edit a waveform:

1. Press the EDIT button, or press the SHIFT button, and then press the OFFSET button.

This will result in the following display.

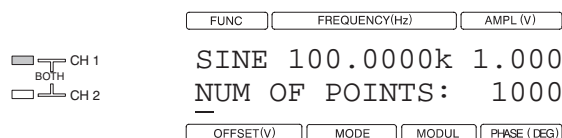

2. Select one of edit functions by using the  $\wedge$  and  $\vee$  buttons to scroll through the edit items until the desired edit item is displayed in the LCD.
3. Press the ENTER button to confirm the selected item.
4. Enter the numeric value, or make the selection.

Editing is either set to a numeric value or selected from a set of selections.

Use the following procedure to select one of the selections.

- a. Use the  $\wedge$  and  $\vee$  buttons to scroll through the set of selections until the desired selection is displayed in the LCD.
- b. Press the ENTER button to confirm the selection.
- c. Press the EXIT (CANCEL) button.

The EXIT (CANCEL) button can be used to return to Step 2; then select the next edit function.

Use the following procedure to input numeric values. Repeat Steps d and e in the following procedure in steps that require the input of multiple numeric values.

- d. Change the value using the numeric keys or control buttons.
- e. Press the ENTER button or unit key to confirm the numeric value.
- f. Press the EXIT (CANCEL) button.

The EXIT (CANCEL) button can be used to return to Step 2.

**Saving an Edited Waveform.** Follow the steps below to save an edited waveform:

1. Select the save function for the edited waveform by using the  $\wedge$  and  $\vee$  buttons to scroll through the edit items until the SAVE TO item is displayed in the LCD.

If the system has not entered into the edit menu, press the EDIT button, or press the SHIFT button, and then press the OFFSET button.

2. Press the ENTER button to confirm the selected item.

This will result in the following display.

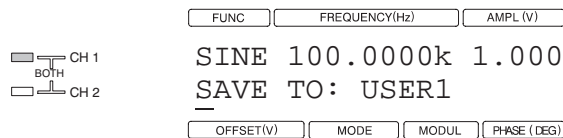

3. Select the user waveform memory name by using the  $\wedge$  and  $\vee$  buttons to scroll through the user waveform memory names until the desired name is displayed in the LCD.
4. Press the ENTER button to confirm the selection.
5. Press the EXIT (CANCEL) button.

The EXIT (CANCEL) button can be used to return to Step 2. Press the EXIT (CANCEL) button again to exit the edit menu.

**Importing a Waveform.** Follow the steps below to import a waveform:

1. Connect the instrument to a transfer source instrument using a GPIB cable. Refer to *Syntax and Commands* on page 4-1 to install a GPIB connection.

To maximize the resolution of the resulting waveform, adjust the vertical settings of the source instrument so that the waveform covers the entire screen and is centered around the horizontal midpoint.

2. Set the GPIB CONFIG to DSOLINK in the SYSTEM menu.
3. Press the EDIT button, or press the SHIFT button, and then press the OFFSET button.
4. Select the import function of waveform by using the  $\wedge$  and  $\vee$  buttons to scroll through the edit items until the IMPORT FROM item is displayed in the LCD.

5. Press the ENTER button to confirm the selected item.

This will result in the following display:



6. Select the transfer source instrument series by using the ^ and v buttons to scroll through the set of selections until the desired instrument name is displayed in the LCD.

The instrument names are TDS, 2400, AFG, and AWG.

7. Press the ENTER button.

The ENTER button starts the import operation. The transfer destination is the edit memory. During the waveform transfer, the block cursor will blink at the IMPORT FROM item selection. When the import completes, the block cursor will change to the underscore cursor.

If the import failed, the message “IMPORT ERROR CHECK CONNECTION” will be displayed. Press the EXIT (CANCEL) button to exit from the error display.

The waveform import function only transfers the waveform shape as it is stored in the memory of the DSO which may be larger than the viewing area. Cyclic frequency, amplitude, and offset information of the waveform are not conserved. Therefore, these waveform parameters need to be adjusted manually. Note that the frequency setting defines the repetition rate for the waveform in memory, and not the cycle frequency.

8. Press the EXIT (CANCEL) button.

The EXIT (CANCEL) button can be used to select the next edit function. Pressing the EXIT (CANCEL) button again exits from the edit menu.

## Setting the Instrument System

Follow the steps below to set the instrument system:

1. Press the SYSTEM button, or press the SHIFT button, and then press the PHASE button.

This will result in the following display:



2. Select the system item in the system menu by using the ^ and v buttons to scroll through the set of selections until the desired item name is displayed in the LCD.
3. Press the ENTER button to confirm the selected item.

---

**NOTE.** The three types of selections in the system menu are: setting a numeric value, selecting from a set of selections, or executing.

---

4. Enter the numeric value, make the selection, or do the execution.

Complete the following steps to input numeric values:

- a. Change the value using the numeric keys or control buttons.
- b. Press the ENTER button to confirm the numeric value.

Complete the following steps to select one of the selections:

- c. Use the ^ and v buttons to scroll through the set of selections until the desired selection is displayed in the LCD.
- d. Press the ENTER button to confirm the selection.

Complete the following step to execute the selected execution selection.

- e. Press the ENTER button.

5. Press the EXIT (CANCEL) button.

The EXIT (CANCEL) button can be used to return to Step 2 and select the next system item. Pressing the EXIT (CANCEL) button again exits from the system menu.

In addition to the EXIT (CANCEL) button, the OFFSET, PHASE, MODE, and MODUL buttons also can be used to return to default display.



## Tutorials

This manual provides simple tutorials to learn the basic procedures for waveform output and basic settings on the AFG320. Four tutorials will be given; these are listed below:

Tutorial 1 : Outputting Standard Waveforms

Tutorial 2 : Setting up Sweep and Output Waveform

Tutorial 3 : Creating a User Waveform and Output Waveform

Tutorial 4 : Importing a Waveform from another instrument

---

**NOTE.** *These tutorials do not cover all of the functions and special features of the instrument. The purpose of the tutorials is only to give you practice in executing basic operations on the instrument.*

---

The AFG310 model (single channel instrument) does not support the CH2 connection, channel switching and BOTH input setting operations in the tutorials. Also note that the settings performed for CH2 in Tutorial 1 can be performed in the same manner for CH1.

The tutorials show the procedures starting from the initial settings state immediately after power on. If these tutorials are attempted without reapplying power or initializing the instrument (with the INITIALIZE item on the SYSTEM menu), the LCD display may differ from that in the tutorials, and operations different from those in the descriptions may be required.

In the sample operation procedure, the cursor must be on an item in the menu to be selected. When performing the sample operation, if the cursor is in the selection area or numeric area, press the EXIT (CANCEL) button to return to the item selection level, and then proceed from this menu level.

---

**NOTE.** *The initialization performed after power is first applied and that performed by an explicit initialization operation are slightly different. See Initialize in the Reference section on page 3–35 for details on the differences.*

---

Refer to *Getting Started* for instructions on how to power on this instrument.

Refer to the beginning of this section if a detailed description of a function is needed.

The following equipment is necessary to execute the tutorials:

- Digital storage oscilloscope. (Tektronix TDS-Series or equivalent.)
- Two 50  $\Omega$  cables. (One cable is needed for tutorial 2 through 4.)
- Two 50  $\Omega$  terminators. (Not necessary if the oscilloscope has 50  $\Omega$  input.)

- One GPIB cable. (Needed for tutorial 4.)
- Signal generator. (Needed for tutorial 1 and 4.)

### Tutorial 1. Outputting Standard Waveforms

This tutorial sets up a model AFG320 as described below, and outputs the waveforms.

|           |                    |           |                    |
|-----------|--------------------|-----------|--------------------|
| CH1       |                    | CH2       |                    |
| FUNCTION  | SINE               | FUNCTION  | PULS               |
| AMPLITUDE | 2 V <sub>p-p</sub> | AMPLITUDE | 5 V <sub>p-p</sub> |
| OFFSET    | 0 V                | OFFSET    | 2.5 V              |
| FREQUENCY | 50 kHz             | FREQUENCY | 50 kHz             |
|           |                    | DUTY      | 25 %               |
| MODE      | CONTinuous         | MODE      | BURST (INFinite)   |

1. Connect the instrument to an oscilloscope using two 50 Ω cables with 50 Ω terminations as shown in Figure 2–17. The instrument is calibrated for waveform output to a 50 Ω load.

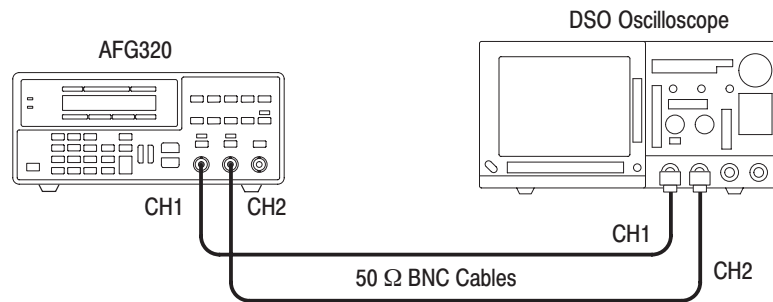

**Figure 2–17: Hookup for Observing Output Waveforms**

2. Set up the oscilloscope as follows and display traces for CH1 and CH2 on the oscilloscope screen.

|                          |          |
|--------------------------|----------|
| Vertical                 | CH1, CH2 |
| CH1, CH2 Scale           | 2 V/div  |
| CH1, CH2 Input Impedance | 50 Ω     |
| Sweep                    | 5 μs/div |
| Trigger Mode             | Auto     |

3. Set CH1 to sine wave and CH2 to pulse wave output.

In the initial setting state or power on default, CH1 and CH2 are both set up for sine wave output. Use the following substep to change the CH2 waveform.

| Main Button           | Control Button or Numeric Input Key |  |
|-----------------------|-------------------------------------|--|
|                       | First Level in the Menu Layers      | Second Level in the Menu Layers                |
| CH, FUNC <sup>1</sup> |                                     | ^ or v button until PULS is displayed<br>ENTER |

<sup>1</sup> If the cursor is on the SINE, there is no need to press the FUNC button.

The figure on the left below shows the power-on default display and the figure on the right below shows that pulse is just confirmed for the CH2 waveform.

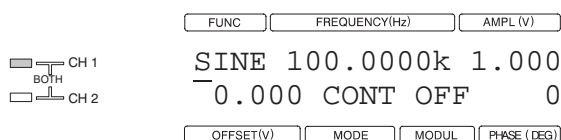

CH 1 LCD Display

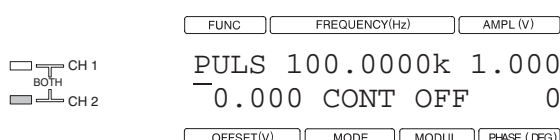

CH 2 LCD Display

4. Set the CH1 and CH2 frequencies to 50 kHz using BOTH input mode.

| Main Button                    | Control Button or Numeric Input Key |                                 |
|--------------------------------|-------------------------------------|---------------------------------|
|                                | First Level in the Menu Layers      | Second Level in the Menu Layers |
| FREQ<br>SHIFT, CH <sup>1</sup> |                                     | 5, 0, kHz/ms/mV <sup>2</sup>    |
| SHIFT, CH <sup>3</sup>         |                                     |                                 |

<sup>1</sup> In BOTH input mode, CH1 and CH2 indicators are on.

<sup>2</sup> The value can be increased or decreased by using the ^ and v buttons.

<sup>3</sup> Cancel the both input mode.

When Pressing the FREQ button, the cursor will be displayed at the frequency value as in the figure below.

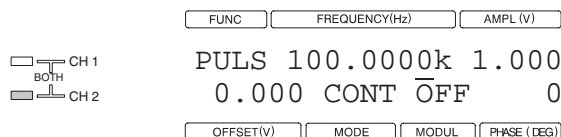

5. Set CH1 amplitude to 2 V<sub>p-p</sub> and CH2 amplitude to 5 V<sub>p-p</sub> output.

| Main Button       | Control Button or Numeric Input Key |                                 |
|-------------------|-------------------------------------|---------------------------------|
|                   | First Level in the Menu Layers      | Second Level in the Menu Layers |
| AMPL <sup>1</sup> |                                     | 5, Hz/s/V                       |
| CH, AMPL          |                                     | 2, Hz/s/V                       |

<sup>1</sup> Make sure that the CH2 indicator is on before pressing the AMPL button.

When Pressing the AMPL button, the cursor will be displayed at the amplitude value as in the figure below.

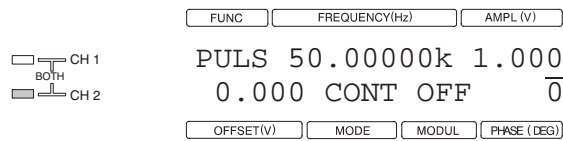

6. Set CH1 offset voltage to 0 V and CH2 offset voltage to 2.5 V output.

In the initial setting state or power on default, CH1 and CH2 offset voltages are both set up for 0 V output. Use the following substep to change the CH2 offset voltage.

| Main Button              | Control Button or Numeric Input Key |                                 |
|--------------------------|-------------------------------------|---------------------------------|
|                          | First Level in the Menu Layers      | Second Level in the Menu Layers |
| CH <sup>1</sup> , OFFSET |                                     | 2, ., 5, Hz/s/V                 |

<sup>1</sup> Make sure that the CH2 indicator is on.

When pressing the OFFSET button, the cursor will be displayed at the offset value as in the figure below.

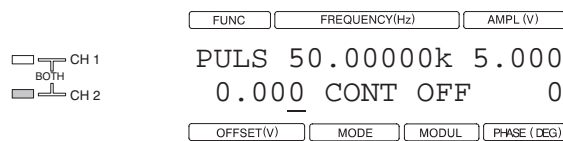

- Set the CH2 pulse waveform duty ratio to 25%.

| Main Button               | Control Button or Numeric Input Key |                                 |
|---------------------------|-------------------------------------|---------------------------------|
|                           | First Level in the Menu Layers      | Second Level in the Menu Layers |
| SHIFT <sup>1</sup> , FUNC |                                     | 2, 5, ENTER                     |

<sup>1</sup> Make sure that the SHIFT indicator is on.

The SHIFT indicator shows that the shift function, which is displayed in blue for the main buttons on the front panel, can be selected.

Since this menu only consists of the pulse wave duty setting item, the cursor is displayed at the location of the duty value.

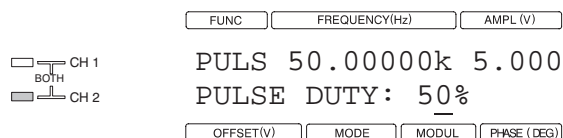

- Set the CH2 burst count to INF (infinity).

| Main Button | Control Button or Numeric Input Key |                                 |
|-------------|-------------------------------------|---------------------------------|
|             | First Level in the Menu Layers      | Second Level in the Menu Layers |
| SHIFT, MODE |                                     |                                 |
| SHIFT       |                                     | +/-                             |

Since this menu only consists of the burst count setting item, the cursor is displayed at the location of the count value.

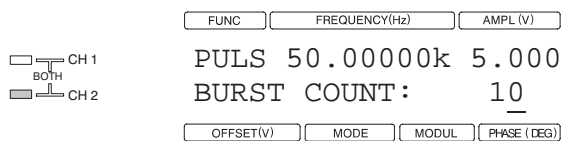

To set the burst count to a value other than infinity, enter the count value using the numeric keys or the ^ and v buttons and confirm that value with the ENTER button.

- Set CH1 operating mode to continuous and CH2 operating mode to burst.

In the initial setting state or power-on default, CH1 and CH2 operating mode are both set up for continuous output. Use the following substep to change the CH2 operating mode.

| Main Button | Control Button or Numeric Input Key |  |
|-------------|-------------------------------------|--|
|             | First Level in the Menu Layers      | Second Level in the Menu Layers                |
| MODE        |                                     | ^ or v button until BRST is displayed<br>ENTER |

When pressing the MODE button, the cursor will be displayed at the name of operating mode as in the figure below.

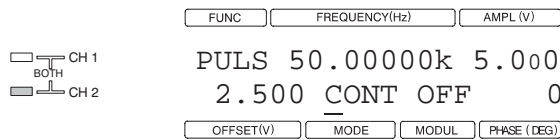

- Press CH1 and CH2 OUTPUT switches to turn on signal output. The LED for the corresponding channel will light.

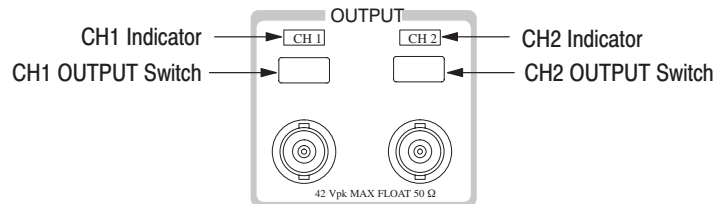

**Figure 2-18: OUTPUT Switches and Indicators on the Front Panel**

A 2 V<sub>p-p</sub> 50 kHz sine wave will be displayed on the oscilloscope as the CH1 waveform. Since CH2 is in the trigger wait state, a linear trace will be displayed.

- When the MANUAL button is pressed a 50 kHz, 25% duty pulse wave with a low level of 0 V and a high level of 5 V will be displayed on the oscilloscope as the CH2 waveform.

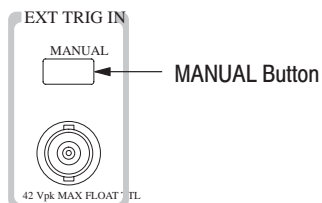
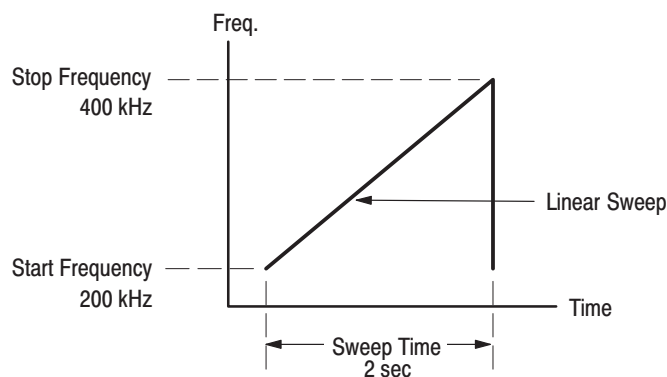

**Figure 2-19: MANUAL Button on the Front Panel**

**Tutorial 2. Setting Up Sweep and Output Waveform**

This tutorial sets up a model AFG320 as described below and outputs the waveforms.

|           |                    |             |         |
|-----------|--------------------|-------------|---------|
| CH1       |                    |             |         |
| FUNCTION  | SINE               | SWP START   | 200 kHz |
| AMPLITUDE | 2 V <sub>p-p</sub> | SWP STOP    | 400 kHz |
| MODE      | CONTINUOUS         | SWP TIME    | 2 sec   |
|           |                    | SWP SPACING | LINEAR  |

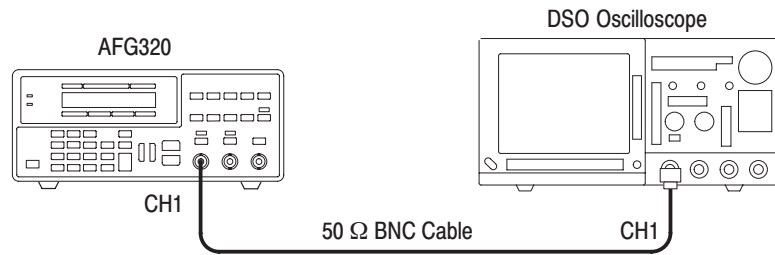

**Figure 2-20: Setup for Sweep Parameters**

There are four sweep parameters: SWP START, SWP STOP, SWP TIME, and SWP SPACING.

Follow the steps below to complete Tutorial 2:

1. Connect the instrument to an oscilloscope using a 50 Ω cable with a 50 Ω termination as shown in Figure 2-21. The instrument is calibrated for waveform output to a 50 Ω load.



**Figure 2-21: Hookup for Observing Output Waveforms**

- Set up the oscilloscope as follows, and display traces for CH1 on the oscilloscope screen.

|                     |          |
|---------------------|----------|
| Vertical            | CH1      |
| CH1 Scale           | 1 V/div  |
| CH1 Input Impedance | 50 Ω     |
| Sweep               | 5 μs/div |
| Trigger Mode        | Auto     |

- Set CH1 amplitude to 2 V<sub>p-p</sub> output.

| Main Button         | Control Button or Numeric Input Key |                                 |
|---------------------|-------------------------------------|---------------------------------|
|                     | First Level in the Menu Layers      | Second Level in the Menu Layers |
| AMPL <sup>1,2</sup> |                                     | 2, Hz/s/V                       |

- Make sure that the CH1 indicator is on before pressing the AMPL button.
- If the cursor is already on the amplitude value, it is not necessary to press the AMPL button.

When Pressing the AMPL button, the cursor will be displayed at the amplitude value as in the figure below.

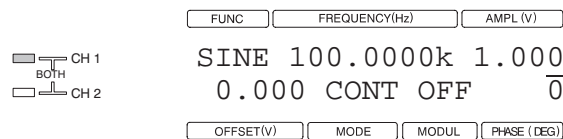



- Set the CH1 sweep start frequency (SWP START) to 200 kHz.

| Main Button  | Control Button or Numeric Input Key      |                                 |
|--------------|--|---------------------------------|
|              | First Level in the Menu Layers           | Second Level in the Menu Layers |
| SHIFT, MODUL | < or > button to display SWP START ENTER | 2, 0, 0, kHz/ms/mV              |
|              |  | EXIT                            |

When Pressing the ENTER button to confirm the SWP START item, the cursor will be displayed at the frequency value as in the figure below.



- Set the CH1 sweep stop frequency (SWP STOP) to 400 kHz.

| Main Button | Control Button or Numeric Input Key |                                 |
|-------------|-------------------------------------|---------------------------------|
|             | First Level in the Menu Layers      | Second Level in the Menu Layers |
|             | > button to display SWP STOP ENTER  | 4, 0, 0, kHz/ms/mV              |
|             |                                     | EXIT                            |

When Pressing the ENTER button to confirm the SWP STOP item, the cursor will be displayed at the frequency value as in the figure below.

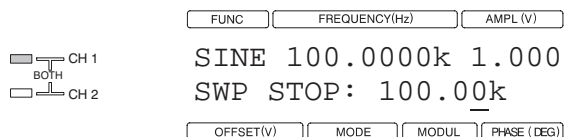

- Set the CH1 sweep time (SWP TIME) to 2 s.

| Main Button | Control Button or Numeric Input Key   |                                 |
|-------------|---------------------------------------|---------------------------------|
|             | First Level in the Menu Layers        | Second Level in the Menu Layers |
|             | > button to display SWP TIME<br>ENTER | 2, Hz/s/V                       |
|             |                                       | EXIT                            |

When Pressing the ENTER button to confirm the SWP TIME item, the cursor will be displayed at the frequency value as in the figure below.

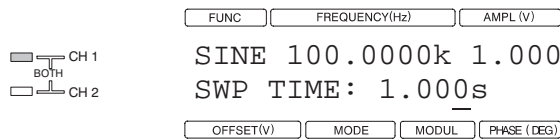

- Select the CH1 sweep spacing (SWP SPACING) for LINEAR.

| Main Button | Control Button or Numeric Input Key                   |  |
|-------------|---|--|
|             | First Level in the Menu Layers                        | Second Level in the Menu Layers          |
|             | > button to display SWP SPACING<br>ENTER <sup>1</sup> | ^ or v button to display LINEAR<br>ENTER |

<sup>1</sup> If LINEAR is displayed as the sweep spacing, there is no need to press the ENTER button. Proceed to step 8.

The figure below shows that the SWP SPACING item is just selected and LINEAR is displayed as the sweep spacing.



In the initial state or power on default, LINEAR is set as the sweep spacing.

8. Set the CH1 modulation (MODUL) mode to sweep (SWP).

| Main Button | Control Button or Numeric Input Key |                                       |
|-------------|-------------------------------------|---------------------------------------|
|             | First Level in the Menu Layers      | Second Level in the Menu Layers       |
| MODUL       |                                     | ^ or v button to display SWP<br>ENTER |

The figure below shows that the MODUL button is just pressed, and the cursor is placed on the OFF.

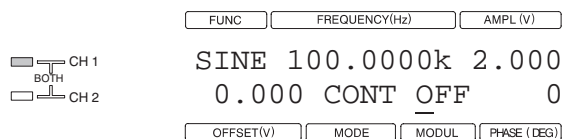

In the initial state or power on default, OFF is set as the current modulation.

9. Press CH1 OUTPUT switches to turn on the signal output. The LED for the corresponding channel will light. See Figure 2–18 for the switch location.

A 2 V<sub>p-p</sub> sine wave that is swept linearly over the sweep frequency range of 200 kHz to 400 kHz with a sweep time of two seconds will be displayed on the oscilloscope as the CH1 output.

### Tutorial 3. Creating a User Waveform and Output Waveform

This tutorial creates the user waveform shown in Figure 2–22 while monitoring the CH1 output waveform. The created waveform is stored in the USER4 user waveform memory.

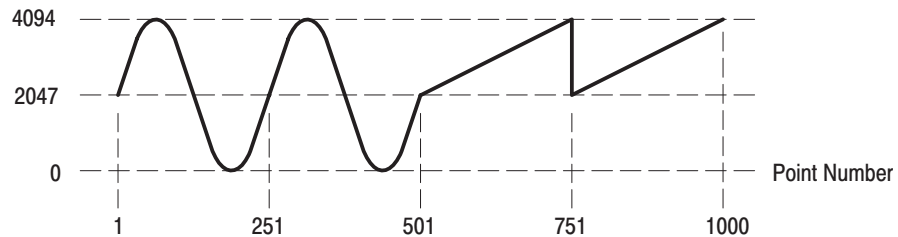

**Figure 2–22: User Waveform to be Created**

This procedure uses the USER4 user waveform memory to save the waveform. It assumes that the lock is released and that the contents of that memory are no longer required. See *Lock Wave* in the *Reference* section on page 3–34 and *Unlock Wave* on page 3–34 for details on locking and unlocking user waveform memory locations.

1. Connect the instrument to an oscilloscope using a 50  $\Omega$  cable with a 50  $\Omega$  termination as shown in Figure 2–23. The instrument is calibrated for waveform output to a 50  $\Omega$  load.

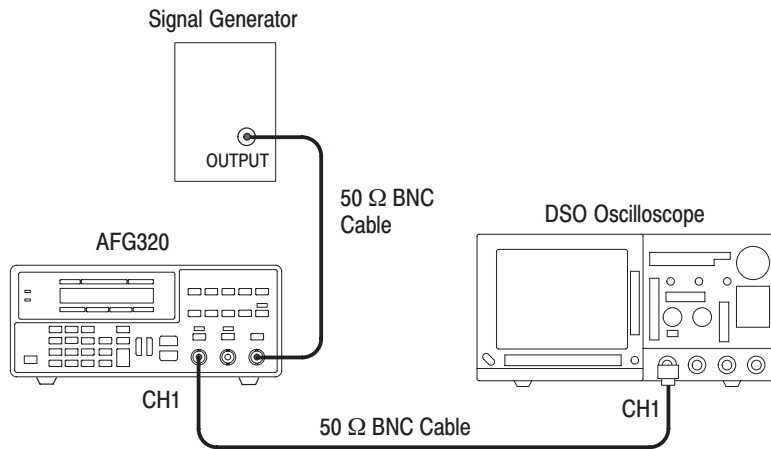

**Figure 2–23: Hookup for Observing Output Waveforms**

2. Set up the oscilloscope as follows, and display traces for CH1 on the vertical center of the oscilloscope screen.

Oscilloscope

|                     |           |
|---------------------|-----------|
| Vertical            | CH1       |
| CH1 Scale           | 0.2 V/div |
| CH1 Input Impedance | 50 Ω      |
| Sweep               | 1 μs/div  |
| Trigger Mode        | Auto      |

Signal Generator

|                  |                 |
|------------------|-----------------|
| Output Frequency | About 1 kHz     |
| Output Waveform  | TTL Level Pulse |

3. Select EDIT as the waveform output from the CH1 connector.

EDIT is the waveform name for the edit memory that will be used for creating and editing the user waveform. This selection allows the waveform being edited to be observed with an oscilloscope in real time.

| Main Button | Control Button or Numeric Input Key |                                     |
|-------------|-------------------------------------|-------------------------------------|
|             | First Level in the Menu Layers      | Second Level in the Menu Layers     |
| FUNC 1, 2   |                                     | ^ or v button to display EDIT ENTER |

- 1 Make sure that the CH1 indicator is on before pressing FUNC button.
- 2 If the cursor is placed in the FUNC column, there is no need to press FUNC button.

The figure below shows that the cursor is displayed at the name of the waveform (or in the FUNC column), and the waveform has not been changed to EDIT.

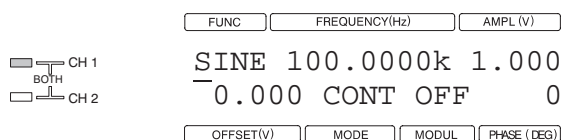

4. Set CH1 operating mode to triggered.

| Main Button | Control Button or Numeric Input Key |                                     |
|-------------|-------------------------------------|-------------------------------------|
|             | First Level in the Menu Layers      | Second Level in the Menu Layers     |
| MODE        |                                     | ^ or v button to display TRIG ENTER |

When Pressing the MODE button, the cursor will be displayed at the name of the operating mode CONT as in figure below.

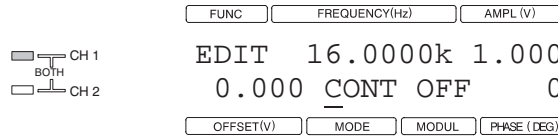

5. Press CH1 OUTPUT switch to turn on signal output. The LED for the corresponding channel will light.

The procedure has set up an oscilloscope display with five vertical divisions and 10 horizontal divisions of the 12 bit by 1000 point edit memory waveform. However, since at this point edit memory has been initialized to the zero level (decimal code value: 2047) by the power-on default, a linear trace will be displayed on the oscilloscope.

6. Enter the edit menu.

| Main Button   | Control Button or Numeric Input Key |                                 |
|---------------|-------------------------------------|---------------------------------|
|               | First Level in the Menu Layers      | Second Level in the Menu Layers |
| SHIFT, OFFSET |                                     |                                 |

When entering the EDIT menu, one of the edit function items is displayed.

In the power-on default, the cursor will be displayed at the location of the first edit function item, NUM OF POINTS as shown in figure below.

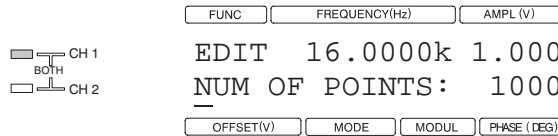

Since there are ten items of edit function in the edit menu, the < and > buttons must be used to switch the item display.

7. Write one period of a 250-point sine wave to edit memory.

| Main Button | Control Button or Numeric Input Key           |                                 |
|-------------|---|---------------------------------|
|             | First Level in the Menu Layers                | Second Level in the Menu Layers |
|             | < or > button to display NUM OF POINTS, ENTER | 2, 5, 0, ENTER                  |
|             |   | EXIT                            |

When pressing the ENTER button to confirm the NUM OF POINTS item selection, the cursor will move to the location of the point value.

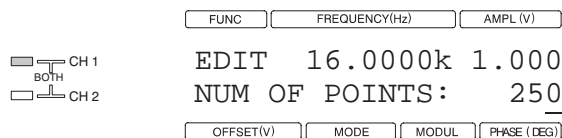

| Main Button | Control Button or Numeric Input Key |                                      |
|-------------|-------------------------------------|--------------------------------------|
|             | First Level in the Menu Layers      | Second Level in the Menu Layers      |
|             | > button to display NEW, ENTER      | ^ or v button to display SINE, ENTER |
|             |                                     | EXIT                                 |

When pressing the ENTER button to confirm the NEW item selection, the cursor will move to the location of the function name. SINE is displayed as the power on default.

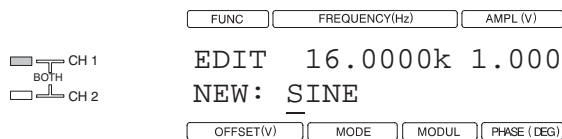

- Convert the 250-point sine wave in edit memory to a four-period, 1000 point waveform.

| Main Button | Control Button or Numeric Input Key |  |
|-------------|-------------------------------------|--|
|             | First Level in the Menu Layers      | Second Level in the Menu Layers                          |
|             | > button to display APPEND, ENTER   | ^ or v button to display EDIT MEMORY, ENTER <sup>1</sup> |
|             |                                     | ENTER <sup>2</sup>                                       |
|             |                                     | EXIT   |

- <sup>1</sup> Increasing one period, 250-points sine wave to two period ,500-points sine wave in the edit memory.
- <sup>2</sup> Increasing two period, 500-points sine wave to four period, 1000-points sine wave in the edit memory.

When pressing the ENTER button to confirm the APPEND item selection, the cursor will move to the location of the source memory name. USER1 is displayed as the power-on default.



- Convert the latter two periods of the sine wave in the edit memory to be two periods of a sawtooth waveform. See Figure 2–22.

| Main Button | Control Button or Numeric Input Key |  |
|-------------|-------------------------------------|--|
|             | First Level in the Menu Layers      | Second Level in the Menu Layers  |
|             | > button to display LINE, ENTER     | 5, 0, 1, ENTER<br>(enter data point value)                             |
|             |                                     | 2, 0, 4, 7, ENTER<br>(enter data value at 501 data point)              |
|             |                                     | 7, 5, 0, ENTER<br>(enter data point value)                             |
|             |                                     | 4, 0, 9, 4, ENTER <sup>1</sup><br>(enter data value at 750 data point) |
|             |                                     | 7, 5, 1, ENTER<br>(enter data point value)                             |
|             |                                     | 2, 0, 4, 7, ENTER<br>(enter data value at 751 data point)              |
|             |                                     | 1, 0, 0, 0, ENTER<br>(enter data point value)                          |
|             |                                     | 4, 0, 9, 4, ENTER<br>(enter data value at 1000 data point)             |
|             |                                     | EXIT   |

<sup>1</sup> Linear interpolation between points is executed when the data values for the second and following points are confirmed with the ENTER button.

**NOTE.** Line Edit is for Auto lines editing and Data Edit is for point by point editing. Refer to EDIT Button of Reference page 3–22.

When pressing the ENTER button to confirm the LINE item selection, the cursor will move to the location of the point number. The number one is displayed as the power-on default.





Two values are displayed, separated by a comma. The value at the left indicates the waveform point number, and the value at the right indicates the vertical value for that point number. Point numbers start from the number one. The vertical axis values range from 0 to 4094 in decimal code. The value 2047 corresponds to the zero level.

When pressing the ENTER button to confirm the point number, the cursor will move to the location of the vertical value for that point number.



If the data value is already the desired value, there is no need to change that value. The ENTER button may be pressed instead.

This completes the creation of the desired user waveform.

**NOTE.** *If the power is turned off at this point, the edit memory waveform will be lost. To allow this waveform to be used the next time the power is turned on, the edit waveform must be saved to a user waveform memory.*

**10.** Save the waveform in the edit memory to the USER4 waveform memory.

| Main Button | Control Button or Numeric Input Key |  |
|-------------|-------------------------------------|--|
|             | First Level in the Menu Layers      | Second Level in the Menu Layers                    |
|             | > button to display SAVE TO, ENTER  | ^ or v button to display USER4, ENTER <sup>1</sup> |
|             |                                     | EXIT   |

<sup>1</sup> **Pressing the ENTER button writes the edit wave to the user waveform memory selected.**

When pressing the ENTER button to confirm the SAVE TO item, the cursor will move to the location of the user waveform memory name for the destination. USER4 is displayed as the power-on default.



The message “\*\*\*SAVING\*\*\*” is displayed in the first line of the LCD while waveform data is being stored in a user waveform memory (nonvolatile memory).

**NOTE.** Do not turn off the power while “\*\*\*SAVING\*\*\*” is displayed, since waveform data stored in internal nonvolatile memory may be lost.

11. Confirm the waveform saved in USER4.

| Main Button | Control Button or Numeric Input Key |                                      |
|-------------|-------------------------------------|--------------------------------------|
|             | First Level in the Menu Layers      | Second Level in the Menu Layers      |
| FUNC        |                                     | ^ or v button to display USR4, ENTER |

**NOTE.** Output Frequency vs. Display Frequency at ARB (EDIT and USER) waveform:

Output Frequency and Display Frequency depend on the AFG internal clock and waveform data points. According to Display Frequency value, the internal clock is generated after calculating internally and set. Therefore USER can not set and change the internal clock value directly. Table 2-3, 2-4, 2-5 and Figure 2-22 to 2-29 are example of Output Frequency vs. Display Frequency at ARB (EDIT and USER) waveform.

**Table 2-3: Case 1: Fixed points (one period signal)**

| Output Frequency = Display Frequency |                      |                     |                     |
|--------------------------------------|----------------------|---------------------|---------------------|
|                                      | minimum              | ◀ example ▶         | maximum             |
| Display Frequency                    | 0.01 Hz              | 32 kHz              | 1.0 MHz             |
| Output Frequency                     | 0.01 Hz              | 32 kHz              | 1.0 MHz             |
| Internal Clock                       | 0.16 Hz              | 512 kHz             | 16 MHz              |
|                                      | 0.01 Hz = 0.16 Hz/16 | 32 kHz = 512 kHz/16 | 1.0 MHz = 16 MHz/16 |

Limitation: Maximum internal clock is 16 MHz. Minimum data points are 10.

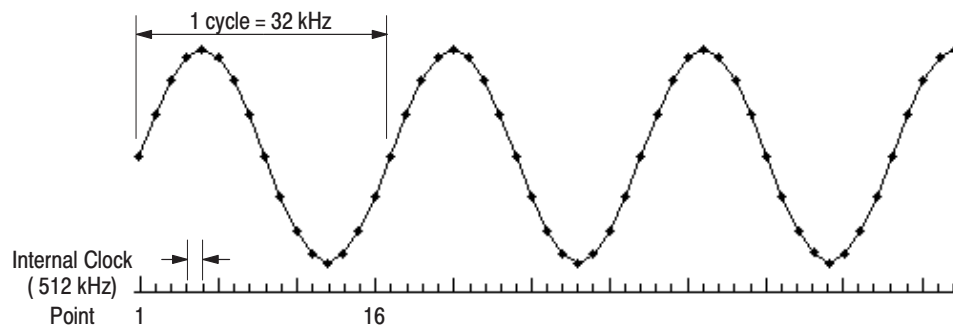

**Figure 2-24: Fixed points (one period signal) User Waveform when Output Frequency = Display Frequency = 32 kHz.**

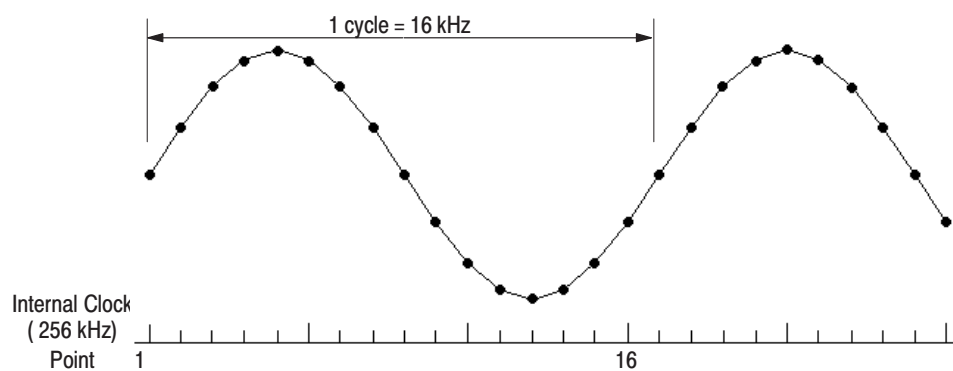

**Figure 2-25: Fixed points (one period signal) User Waveform when Output Frequency = Display Frequency = 16 kHz.**

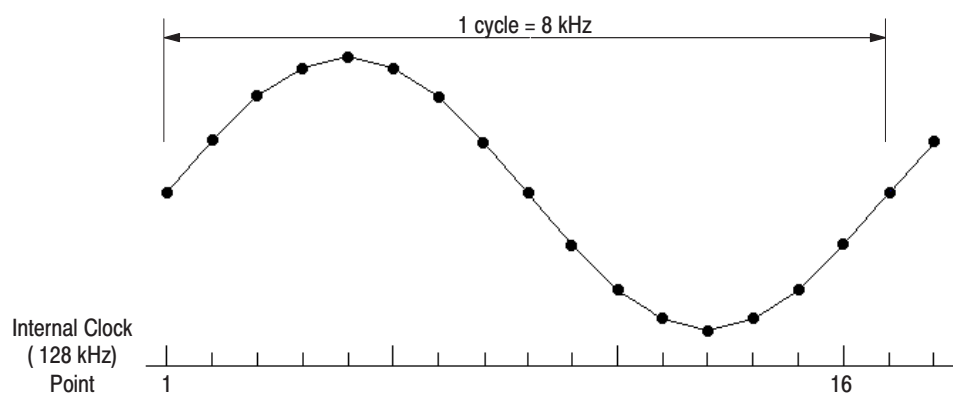

**Figure 2-26: Fixed points (one period signal) User Waveform when Output Frequency = Display Frequency = 8 kHz.**

**Table 2-4: Case 2: Variable points (one period signal)**

| <b>Output Frequency = Display Frequency = Internal clock / Data points = 16 kHz</b> |         |         |         |          |
|---|---------|---------|---------|----------|
| Number of points  | 10      | 16      | 32      | 64       |
| Display / Output Frequency  | 16 kHz  | 16 kHz  | 16 kHz  | 16 kHz   |
| Internal Clock  | 160 kHz | 256 kHz | 512 kHz | 1024 kHz |
| <b>Output Frequency = Display Frequency = Internal clock / Data points = 8 kHz</b>  |         |         |         |          |
| Number of points  | 10      | 16      | 32      | 64       |
| Display / Output Frequency  | 8 kHz   | 8 kHz   | 8 kHz   | 8 kHz    |
| Internal Clock  | 80 kHz  | 160 kHz | 256 kHz | 512 kHz  |

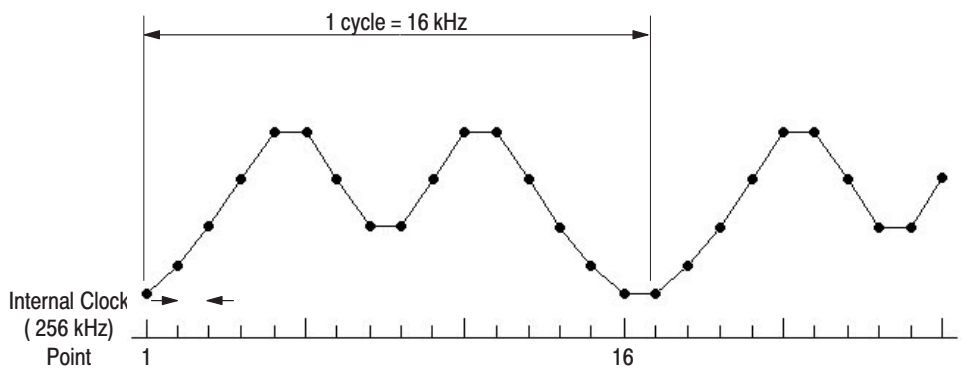

**Figure 2-27: Variable points (one period signal) User Waveform when Output Frequency = Display Frequency = 16 kHz , 256 kHz Internal clock**

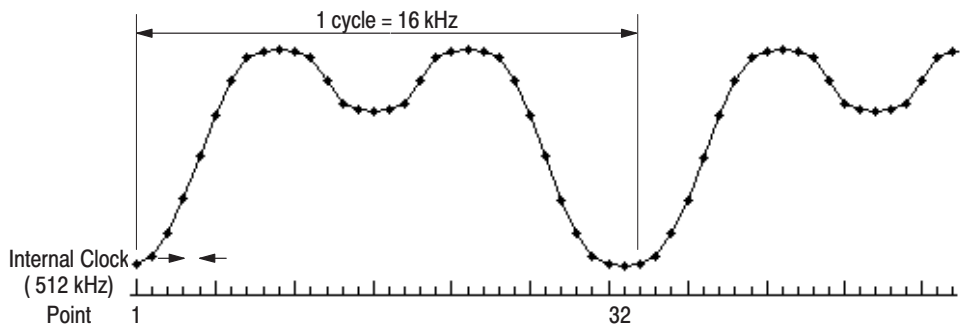

**Figure 2-28: Variable points (one period signal) User Waveform when Output Frequency = Display Frequency = 16 kHz , 512 kHz Internal clock**

**Table 2-5: Case 3: Fixed points (including M period signal)**

| <b>Output Frequency = Display Frequency = Internal clock / Data points × M period</b> |  |   |   |
|---|--|---|---|
| <b>Example: Fixed point 16 (two period signal)</b>                                    |  |   |   |
|   | minimum                                    | ◀ example ▶                               | maximum                                   |
| Display Frequency   | 0.01 Hz                                    | 32 kHz                                    | 1.0 MHz                                   |
| Output Frequency  | 0.02 Hz                                    | 64 kHz                                    | 2.0 MHz                                   |
| Internal Clock  | 0.16 Hz                                    | 512 kHz                                   | 16 MHz                                    |
|   | 0.02 Hz =<br>$2 \times 0.16 \text{ Hz}/16$ | 64 kHz =<br>$2 \times 512 \text{ kHz}/16$ | 1.0 MHz =<br>$2 \times 16 \text{ MHz}/16$ |

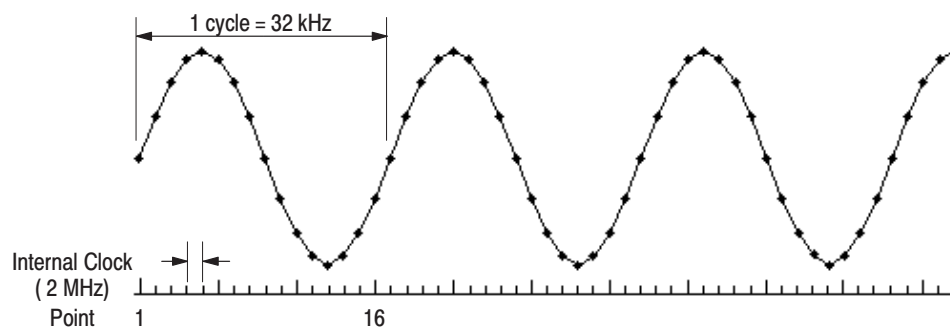

**Figure 2-29: Fixed point (one period signal) User Waveform when Output Frequency = Display Frequency = 32 kHz.**

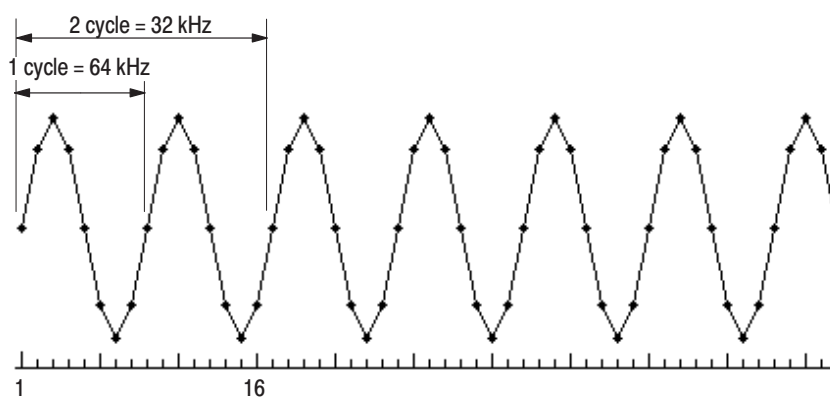

**Figure 2-30: Fixed point User Waveform when (two period signal) Display Frequency = 32 kHz, (one period signal) Output Frequency = 64 kHz.**

### Tutorial 4. Importing a Waveform from Another Instrument

This instrument allows waveforms to be easily transferred from Tektronix TDS and 2400 series digital storage oscilloscopes (DSO) and AFG/AWG series waveform generators without the use of an external controller over a GPIB cable.

Tutorial 4 transfers a waveform acquired in the CH1 memory of a Tektronix TDS Series oscilloscope to this instrument's edit memory. The edit memory is automatically selected as the transfer destination.

This procedure assumes that edit memory, which is the waveform transfer destination, does not hold a waveform required by the user.

Waveform import requires that the GPIB CONFIG is set for DSOLINK. See *GPIB Config* in the *Reference* section of this manual on page 3–32 for details on GPIB CONFIG.

1. Connect the AFG320 instrument to an oscilloscope using a GPIB cable. Connect the signal generator to the oscilloscope using a 50  $\Omega$  BNC cable with a 50  $\Omega$  termination as shown in Figure 2–31.

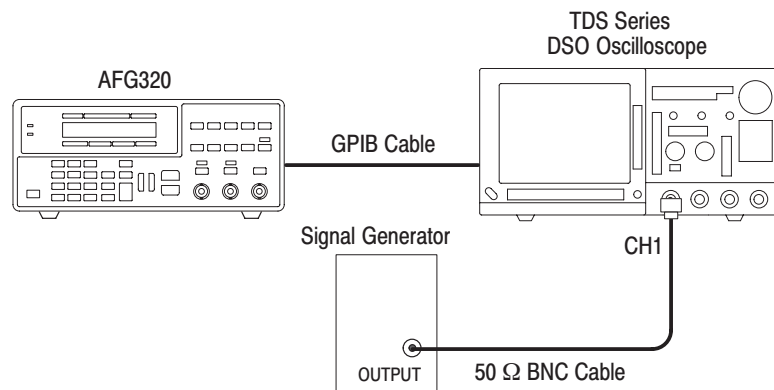

**Figure 2–31: Hookup for Importing Waveform**

To maximize the resolution of the resulting waveform, adjust the vertical settings of the source instrument so that the waveform covers the entire screen and is centered around the horizontal midpoint.

2. Enter the SYSTEM menu and set GPIB configuration for DSOLINK.

| Main Button  | Control Button or Numeric Input Key                      |   |
|--------------|--|---|
|              | First Level in the Menu Layers                           | Second Level in the Menu Layers         |
| SHIFT, PHASE | < or > button to display GPIB CONFIG, ENTER <sup>1</sup> | ^ or v button to display DSOLINK, ENTER |

<sup>1</sup> If the DSOLINK is displayed as the selection in the GPIB CONFIG item, there is no need to press ENTER button. Press EXIT button instead.

3. Enter EDIT menu and execute the import function.

| Main Button   | Control Button or Numeric Input Key         |  |
|---------------|---|--|
|               | First Level in the Menu Layers              | Second Level in the Menu Layers                  |
| SHIFT, OFFSET | < or > button to display IMPORT FROM, ENTER | ^ or v button to display TDS, ENTER <sup>1</sup> |

<sup>1</sup> Pressing the ENTER button executes the waveform import from the transfer source to the edit memory.

When pressing the ENTER button to confirm the IMPORT FROM item, the cursor will be displayed at the name of transfer source instrument as in the figure below.



Even if the TDS has been selected, pressing the ENTER button executes the import function.

A blinking block cursor is displayed on the IMPORT FROM item selection during import execution. When the import completes, the block cursor switches to become an underscore cursor.

If the import failed, the message “IMPORT ERROR CHECK CONNECTION” will be displayed. Press the EXIT (CANCEL) button to exit from the error display.

**NOTE.** An error will occur if a system controller is connected to the bus.

The waveform import function transfers the waveform shape, which may be larger than the viewing area, as it is stored in the memory of the DSO. Cyclic waveform frequency, amplitude, and offset information are not conserved.

Therefore, these waveform parameters need to be adjusted manually. Note that the frequency setting defines the repetition rate for the waveform in memory, and not the cycle frequency.

This completes the import of the TDS CH1 waveform data to the edit memory. If the power is turned off at this point, the edit memory waveform will be lost. To allow this waveform to be used the next time the power is turned on, the edit waveform must be saved to a user waveform memory. See step 10 on page 2-43.

See *Tutorial 1* beginning on page 2-28 for the procedure to output the edit memory waveform. The waveform can be observed by selecting EDIT at the FUNC item in the tutorial procedure. However, do not turn off the power in the Tutorial 1 procedure. Power off causes initialization of the edit memory.

---

**NOTE.** *If the imported waveform data is not full scale on the edit memory vertical axis, the value of the output waveform amplitude will differ from that displayed on the LCD.*

---



# Reference

This section discusses the five types of menu classifications used in the menu structure, how to use the menu buttons, and their functions.

## Menu Structure

Menus are classified into the five types listed below. Each type records the main menu tree for that type.

- Setting Menu
- Menus Other than Setting Menu
  - Parameter Menu
  - Editing Menu
- Recall/Save Menu
- System Menu

### Setting Menu

In the default display state, the setting menu is opened and the values of all items are displayed. Menu layers are generally divided into two levels, and are displayed in the order menu item, and selection or value. Moving between menus is generally performed as follows.

- Menu items are selected by pressing the menu item buttons on the upper right of the front panel.
- Selection display is switched in order from top to bottom by pressing the  $\wedge$  button and in the reverse order by pressing the  $\vee$  button.
- Numeric values can be changed with the  $\wedge$  and  $\vee$  buttons. Alternatively, the value can be entered with the numeric keys and confirmed by pressing a unit key or the ENTER button.

**Setting Menu Structure.** The setting menu is used to set the basic parameters for waveform output. This menu sets the values of the frequency, amplitude, offset, and phase parameters and selects the waveform type, the operating mode, and the modulation function for waveform output. Refer to Figure 3-1.

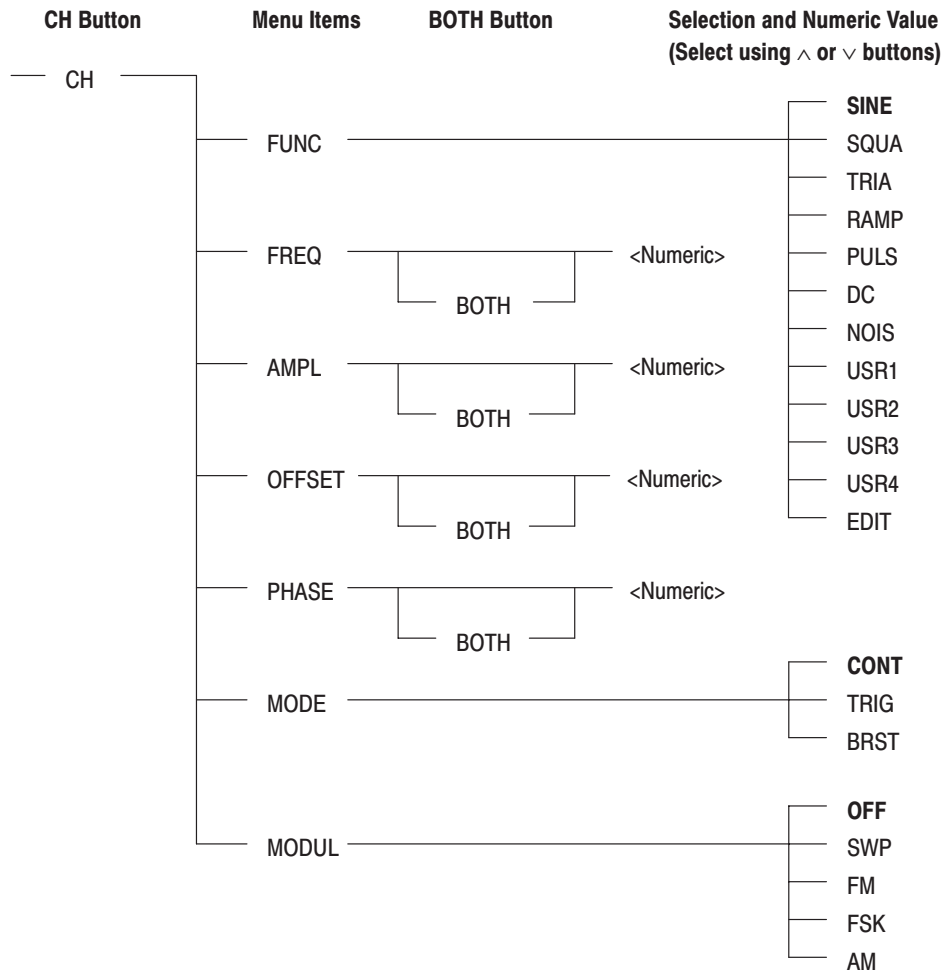

**Figure 3-1: Setting Menu Structure**

Prior to using the setting menu, for models that support two channels, the channel indicators should be checked and the desired channel selected as required.

The CH and BOTH buttons are only valid on instruments with two channels. Selections displayed in bold type in the figure are selected at power on by initialization and by the secure function.

**Menus Other Than Setting Menu**

Menu layers are generally divided into three levels and are displayed in the following order: main menu, menu item, and selection or value. Items to the left are higher level items. Some menus do not have channel switching or menu item selections. Moving between menus is generally performed as follows.

- Main menus are selected by pressing the menu buttons on the upper right of the front panel.

- Menu item display is switched in order from top to bottom by pressing the > button and in the reverse order by pressing the < button. A selection is confirmed by pressing the ENTER button.
- Selection display is switched in order from top to bottom by pressing the ^ button and in the reverse order by pressing the v button. A selection is confirmed by pressing the ENTER button.
- Numeric values can be changed with the ^ and v buttons. Alternatively, the value can be entered with the numeric keys and confirmed by pressing a unit key or the ENTER button.
- The EXIT (CANCEL) button is used to return to higher levels from lower levels. The instrument will return to the default LCD display if this button is pushed several times.
- The instrument can be set to the selection state for the setting menu items by pressing the corresponding button, even in states where the instrument has not returned to the default display. The OFFSET, PHASE, MODE, and MODUL buttons return the instrument to the default LCD display.

**Parameter Menu.** The parameter menu includes the FUNC PARAMETER, MODE PARAMETER, and MODUL PARAMETER items and is used to set the duty for pulse waveforms, the burst count, and the parameter values for the modulation.

Prior to using the parameter menu, for models that support two channels, the channel indicators should be checked and the desired channel selected as required.

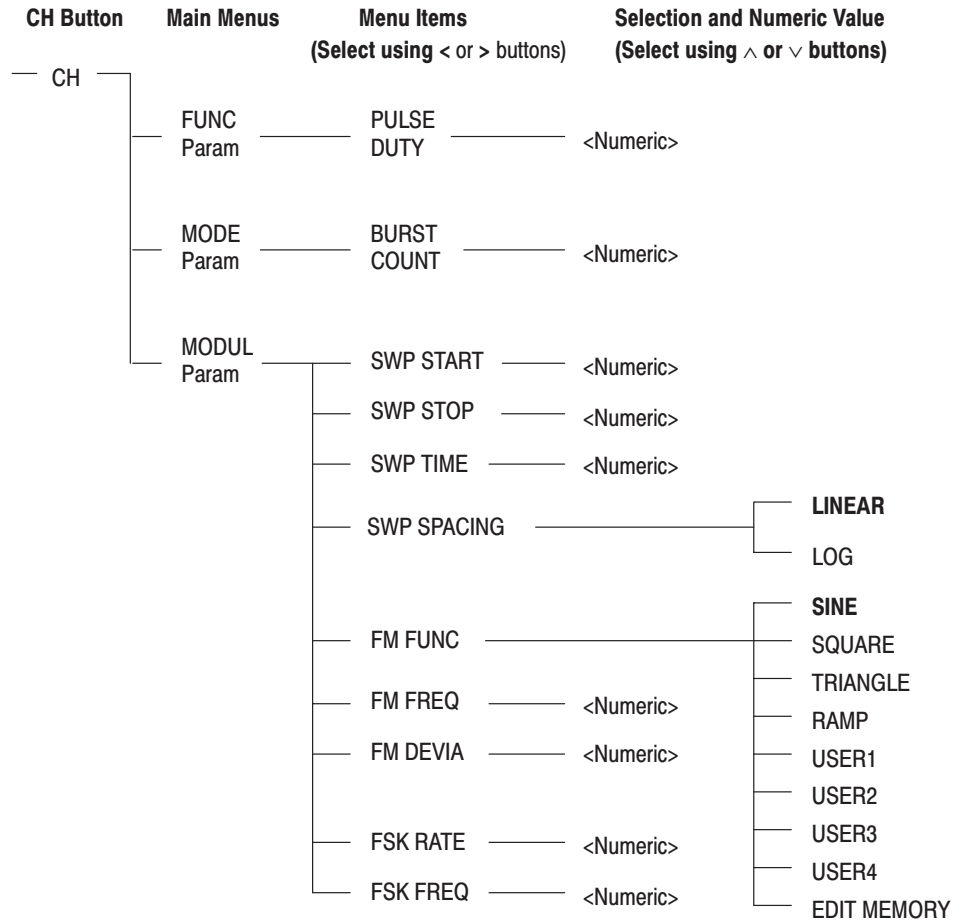

**Figure 3-2: Parameter Menu Structure**

The CH button is only valid on instruments with two channels. Selections displayed in bold type in the figure are selected at power on, by initialization, and by the secure function.

**Edit Menu.** The edit menu is used to create and edit user waveforms and to import waveforms. The channel indicator display is completely unrelated to the functions of the edit menu.

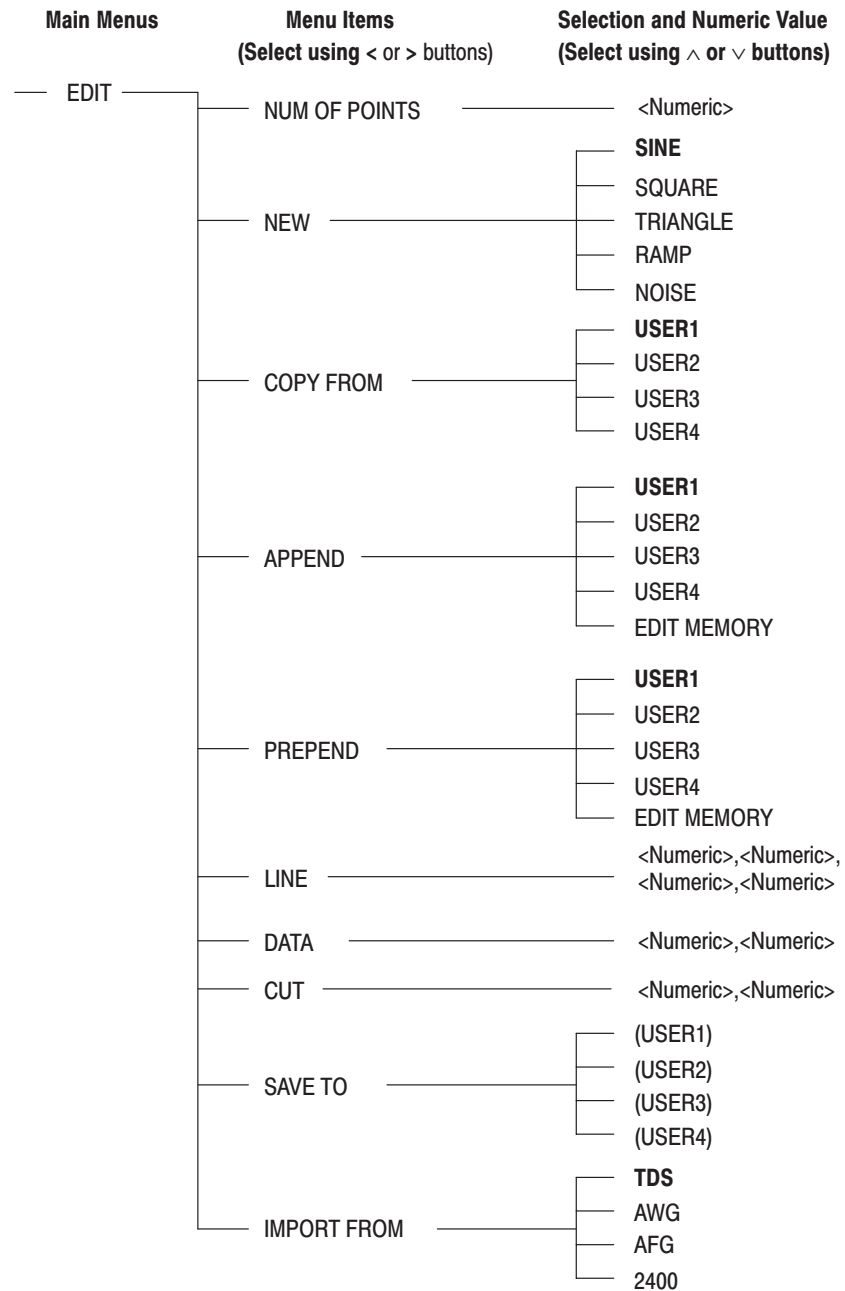

**Figure 3-3: Edit Menu Structure**

Selections displayed in bold type in the figure are selected at power on, and by the secure function.

Selections shown in parentheses are not displayed when the user waveform memory is locked. NONE is displayed when all user waveform memories are locked.

### Recall and Save Menu

The recall/save menu stores and recalls up to 20 waveform output settings in internal, nonvolatile memory.

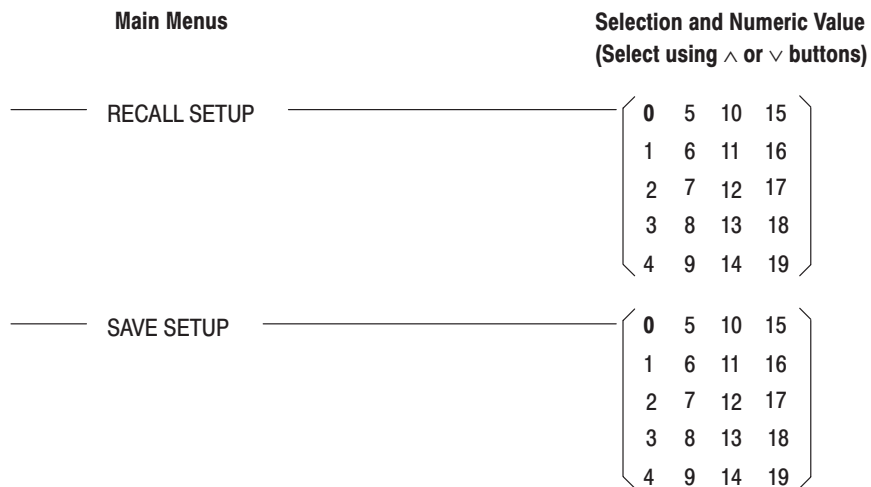

**Figure 3-4: Recall and Save Menu Structure**

Selections displayed in bold type in the figure are selected at power on, and by the secure function.

### System Menu

The system menu is used for the following settings:

- Setting GPIB address and GPIB configuration.
- On/Off setting for Step Recall Mode, and setting the last memory number can be read for Step Recall Mode
- On/Off setting for key click or beep sound
- Lock or Unlock waveform memories
- Copy CH1 parameter values to CH2
- Execute Initialize or factory reset

- Display serial number of this instrument
- Execute self test or calibration

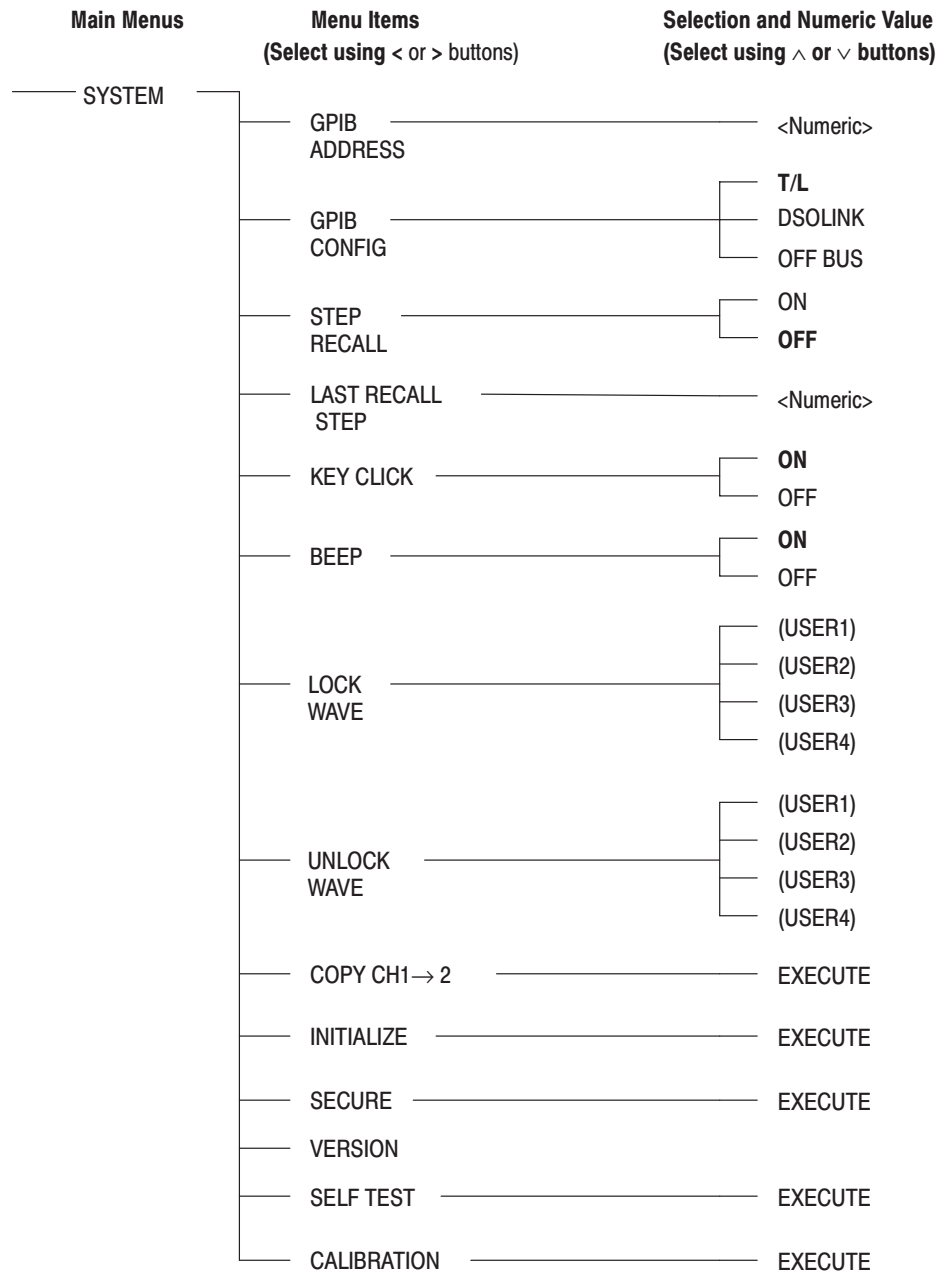

**Figure 3-5: System Menu Structure**

Selections displayed in bold type in the figure are selected by the secure function.

Selections shown in parentheses are displayed in either LOCK WAVE or UNLOCK WAVE, depending on whether the user waveform memory is locked or unlocked. NONE is displayed when there are no lock or unlock selections.

## Menu Button Functions

This section describes the functions that the menu buttons control.

The buttons shown in Figure 3–6 can set all the settings supported by the instrument.

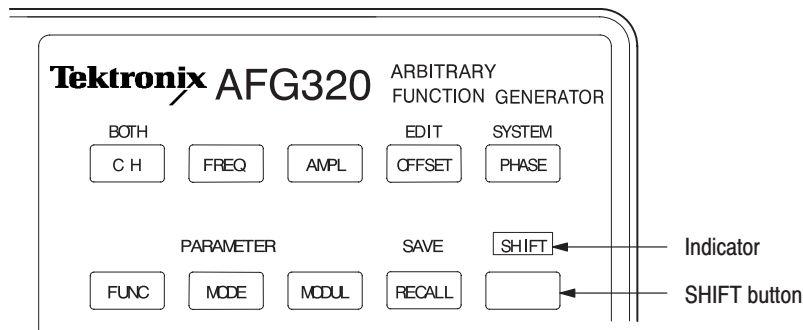

**Figure 3–6: Location of the SHIFT Button and Indicator**

### SHIFT Button

The SHIFT button selects the shift functions that are displayed in blue for the main buttons on the front panel. When the SHIFT button is pressed the indicator lights and the instrument goes to the shift state.

Selecting a shift function or pressing the SHIFT button once more clears the shift state and turns off the indicator.

Pressing a button with no shift function in the shift state executes that buttons, function and clears the shift state.

### CH / BOTH Button (AFG320 Only)

The AFG320 supports setting each channel independently. The channel must be selected before setting a parameter.

The channel whose indicator is on becomes the object of any setting operation. BOTH input mode is indicated by both indicators being on.

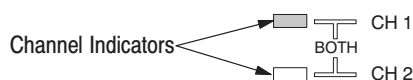

**Figure 3–7: Channel Indicators**



**CH Button.** The CH button changes the target channel each time the value for a setting menu item or parameter menu item is input. The CH button switches the selected channel between CH1 and CH2 each time it is pressed.

**BOTH Button (SHIFT → CH).** The BOTH button sets up a mode that allows the value of the setting menu items (FREQ, AMPL, OFFSET and PHASE) to be set to the same value in both channels. This allows the same value to be input to both channels at the same time.

To set up BOTH input mode, first select the desired setting menu item (FREQ, AMPL, OFFSET or PHASE) and then press the BOTH button. (Press the SHIFT button and then the CH button in that order.)

The BOTH input state is recorded along with each setting menu item. For example, if only the AMPL item has the BOTH input state selected, both channel indicators will light when the AMPL button is pressed. When the button for an item that does not have BOTH input mode selected, the indicator for the currently selected channel will light. For these items, the CH button will operate normally to switch channels.

When BOTH input state is entered, the value of the item for the displayed channel becomes the value for both channels. However, if this value exceeds the maximum value for the channel that is not displayed, both channels are set to that largest (limiting) value. For example, if the CH1 waveform is a sine wave and its frequency is 1 MHz, and the CH2 waveform is a triangular wave with a frequency of 10 kHz, pressing the BOTH button with CH1 item displayed and the FREQ item selected causes both the CH1 and CH2 frequencies to be set to 100 kHz.

To clear the BOTH input state, select the item with the BOTH input state selected and press the BOTH button once again. (Press the SHIFT button and then the CH button in that order.)

### **FREQ Button**

The FREQ button is used to set the output frequency. The value of the frequency is entered using the numeric keys or the control buttons.

Frequencies have a resolution of 10 mHz or seven digits. The default frequency is 100 kHz. However, DC and noise waveforms do not have a frequency setting. The highest frequency allowed differs for different waveforms.

---

**NOTE.** The maximum frequency for a user and edit waveform are restricted according to the number of points that make up the waveform. A user and edit waveform with 10 points have a maximum frequency of 1.6 MHz.

The frequency parameter for a user and edit waveform sets the repetition frequency for the waveform in memory. For example, if the AFG310 and AFG320 Arbitrary Function Generator memory contains a wave of two cycles and the frequency is set to 10 kHz, the resulting waveform will have a cycle frequency of 20 kHz ( $2 * 10 \text{ kHz}$ ).

When a sine wave or square wave is output in triggered or burst mode, the maximum frequency is limited to 1 MHz.

---

**Table 3-1: Frequency Setting Range**

| <b>FUNC Waveform</b> | <b>Minimum Frequency</b> | <b>Maximum Frequency</b> |
|----------------------|--------------------------|--------------------------|
| SINE                 | 10 mHz                   | 16 MHz                   |
| SQUA                 | 10 mHz                   | 16 MHz                   |
| TRIA                 | 10 mHz                   | 100 kHz                  |
| RAMP                 | 10 mHz                   | 100 kHz                  |
| PULS                 | 10 mHz                   | 100 kHz                  |
| USER1 ~ USER4        | 10 mHz                   | 1.6 MHz                  |
| EDIT                 | 10 mHz                   | 1.6 MHz                  |

### AMPL Button

The AMPL button is used to set the amplitude. The value of the amplitude is entered using the numeric keys or the control buttons.

The amplitude can be set to a value in the range 50 mV to 10.00  $V_{p-p}$  with a minimum step size of 5 mV. The value displayed is the value when the output is terminated with 50  $\Omega$ . The actual output amplitude will be about twice the displayed value if the output is open. The default amplitude setting is 1  $V_{p-p}$ . There is no amplitude item for a DC waveform.

If the waveform data does not use the full range of the DAC (the 12-bit digital to analog converter), the output amplitude of the user (or edit) waveform and the value displayed in the LCD will differ.

The maximum output voltage ( $V_{max}$ ) that the instrument can produce is  $\pm 5 \text{ V}$  when terminated with 50  $\Omega$ . The valid range for the amplitude setting is restricted in a manner that varies with the offset voltage as expressed by the following equations.

$$V_{\text{ampl}} \leq 2(|V_{\text{max}}| - |V_{\text{offset}}|)$$

$$V_{\text{max}} = \pm 5 \text{ V}$$

**OFFSET Button**

The OFFSET button is used to set the offset level. The value of the offset is entered using the numeric keys or the control buttons.

The offset can be set to a value in the range  $\pm 5$  V with a minimum step size of 5 mV. The value displayed is the value when the output is terminated with  $50 \Omega$ . The actual output offset will be about twice the displayed value if the output is open. The default offset setting is 0 V.

The user and edit waveform offset expresses a voltage with respect to the middle level (2047 as a decimal code) of the full range of the DAC (the 12-bit D/A converter).

The valid range for the offset voltage setting is in the range  $\pm 0.75$  V when the amplitude setting is  $500 \text{ mV}_{\text{p-p}}$  or smaller.

$$V_{\text{amp}} \leq 500 \text{ mV}_{\text{p-p}}$$

$$-0.75 \text{ V} \leq V_{\text{offset}} \leq + 0.75 \text{ V}$$

The valid range for the offset voltage setting is restricted according to the following formula when the amplitude setting is  $505 \text{ mV}_{\text{p-p}}$  or larger, for a  $V_{\text{max}}$  value of  $\pm 5$  V.

$$V_{\text{amp}} \geq 505 \text{ mV}_{\text{p-p}}$$

$$|V_{\text{offset}}| \leq |V_{\text{max}}| - \frac{V_{\text{ampl}}}{2} \qquad V_{\text{max}} = \pm 5 \text{ V}$$

---

**NOTE.** When the amplitude setting is 505 mV or higher and the offset value (the absolute value) is 755 mV or higher, if the amplitude is modified to be under  $500 \text{ mV}_{\text{p-p}}$  then the offset setting will be automatically changed to 750 or  $-750 \text{ mV}$ .

---

**PHASE Button**

The PHASE button is used to set the phase. The value of the phase is entered using the numeric keys or the control buttons.

The phase can be set to a value in the range  $\pm 360^\circ$  with a minimum step size of  $1^\circ$ . The default phase setting is  $0^\circ$ .

---

**NOTE.** The phase resolution may become larger (rougher) than  $1^\circ$  depending on the number of points in the waveform when a triangular wave, ramp wave, pulse wave, user waveform, or edit waveform is selected.

---

The phase will be fixed at  $0^\circ$  when the following settings have been made:

- Phase for sine wave and square wave in triggered or burst mode when the output frequency is higher than 100 kHz

- Phase for a waveform other than sine and square wave in continuous mode

**Table 3-2: Phase Range**

| Operating Mode | Sin and Square Wave      |                       | Triangle, Ramp, Pulse, User, and Edit Wave |
|----------------|--------------------------|-----------------------|--|
|                | $f \leq 100 \text{ kHz}$ | $100 \text{ kHz} < f$ |  |
| Continuous     | $\pm 360^\circ$          | $\pm 360^\circ$       | $0^\circ$ Fixed                            |
| Triggered      | $\pm 360^\circ$          | $0^\circ$ Fixed       | $\pm 360^\circ$                            |
| Burst          | $\pm 360^\circ$          | $0^\circ$ Fixed       | $\pm 360^\circ$                            |

When the operating mode (set from the MODE menu) is triggered or burst mode, a voltage corresponding to the phase is generated before a trigger is applied. The waveform output starts from the phase at the point the trigger is applied. Figure 3-9 shows an example of triggered mode waveform output in which the phase is set to  $+45^\circ$ .

In continuous operating mode the phase setting has no discernible effect on the output waveform in single channel instruments. However, in two channel instruments, a phase difference between the channels will be apparent.

### **FUNC Button**

The FUNC button selects a waveform (a standard waveform, defined by the user and stored in memory, or the waveform written to edit memory). The waveform selected will be the waveform that is output.

The maximum frequency that can be output differs for different waveforms. When the waveform type is changed and the current frequency setting exceeds the maximum frequency for the newly selected type, the frequency setting will automatically be set to the maximum frequency for the new type. For example, if the instrument is set up to output a 1 MHz sine wave and the waveform type is changed to pulse the output frequency will automatically be changed to 100 kHz.

There are seven standard waveforms: sine, square, triangle, ramp, pulse, DC, and noise.

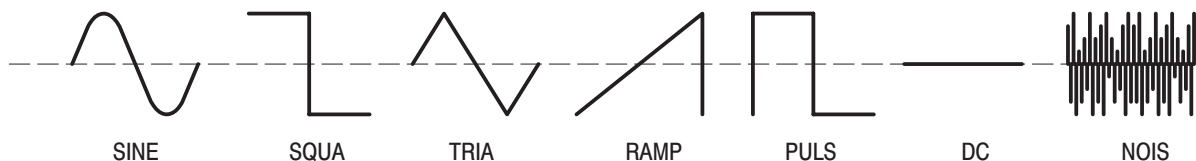

The triangle, ramp, pulse, DC, and noise waveforms are created using the arbitrary waveform generator circuitry in the AFG300. The noise waveform is a 1000 point record of random data that is output at 16Mb/s, and then passed

through a 5MHz filter. The output amplitude displayed for the noise waveform represents the maximum data value in the data table. Because of the effect of the 5MHz filter the actual amplitude output will be approximately 25% lower. The noise data can also be used as a source for USER waveforms using the NEW function in the EDIT menu, as described on page 3–24.

DC has the only one parameter (offset). Noise has two parameters (amplitude and offset). Although the operating mode and modulation parameters may be displayed on the lower menu, they do not have any effect on the DC or Noise functions

**Difference between SQUARE and PULSE.** The instrument supports square wave output up to 16 MHz. Although pulse waveforms can only be generated up to 100 kHz, the duty of the pulse waveform can be adjusted with the FUNC PARAMETER menu.

**USER Waveform and EDIT Waveform.** User waveforms must first be created using the edit menu and then stored in user waveform memory, which has four locations: USER1, USER2, USER3, and USER4. Also, the waveform being edited using the edit menu can be output by selecting EDIT MEMORY.

When shipped from the factory, the four user memories USER1, USER2, USER3, and USER4 are preloaded with sampled waveforms: a sampling function, a double exponential pulse waveform, a damped sine wave, and an M-series, pseudo-random pulse waveform. Refer to the *Operating Basics* section, *Editing, Saving, and Importing Waveforms* on page 2–19 for details on these waveforms.

## **FUNC-PARAMETER Button**

(SHIFT → FUNC)

The FUNC PARAMETER button sets the duty for pulse waveforms. When pulse has been selected with the FUNC item in the setting menu, the instrument will output a pulse waveform with the duty set in this menu. The default duty setting is 50%. Although the pulse duty parameter is displayed on the lower menu anytime the FUNC PARAMETER button is activated, the pulse duty only effects pulse functions.

The value of the duty expresses the pulse width in relation to the period of the pulse waveform as a percentage. The duty can be set in the range 1 to 99% of the period in 1% steps.

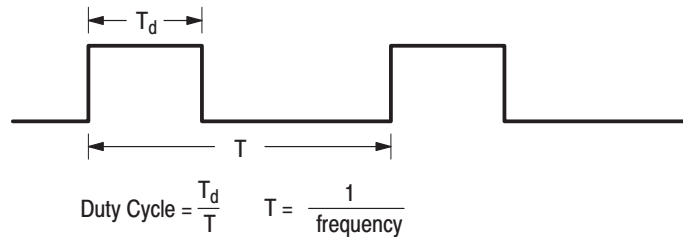

**Figure 3-8: Pulse Duty**

### MODE Button

The MODE button selects the operating mode to be one of three modes: CONT, TRIG, or BRST. CONT (Continuous Mode) is the default setting.

**Continuous Mode (CONT).** When CONT is selected, the instrument immediately enters continuous mode and outputs the selected waveform continuously.

**Triggered Mode (TRIG).** In triggered mode, exactly one period of the selected waveform is output each time a trigger event occurs.

When triggered mode is set up, the instrument waits for a trigger event to occur.

In the trigger wait state, the instrument generates the voltage for the data corresponding to the first point of the waveform based on the values of the amplitude, offset and phase settings.

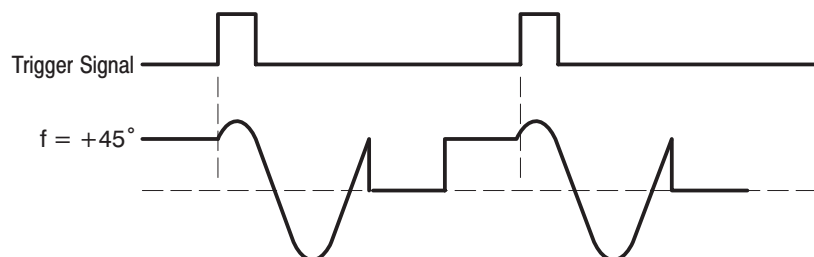

**Figure 3-9: Timing Chart in the Triggered Mode**

Trigger events can be generated by an external TTL level signal applied to the EXT TRIG IN connector, by a GPIB trigger command, or by pressing the MANUAL button on the front panel. The instrument ignores trigger events due to the MANUAL button being pressed, external trigger signals, or trigger commands during waveform output.

The trigger event occurs on the rising edge of the external trigger signal. This instrument does not support selection of the trigger level or polarity.

**Burst Mode (BRST).** When a trigger event occurs in burst mode, the waveform is output for the number of cycles specified by the MODE-PARAMETER menu BURST COUNT item. Figure 3–10 below shows an example of waveform output when the burst count is set to the number three. Trigger events that occur during burst output are ignored. Note that the burst count can be set to either a value between 1 and 60,000 or infinity (using the INF button).

When burst mode is set up, the instrument waits for a trigger event to occur.

The voltage generated in the trigger wait state, trigger event occurrence, the fact that trigger events are ignored during waveform output, and the characteristics related to external trigger events are identical to those in triggered mode.

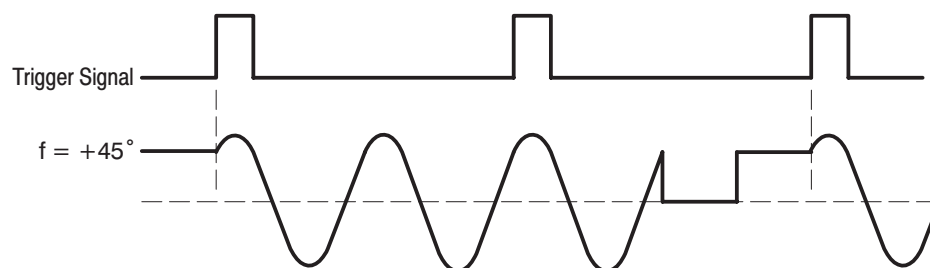

**Figure 3–10: Timing Chart in the Burst Mode**

---

**NOTE.** When a sine or square wave is output in burst mode, the output will stop 100 seconds after the output starts, even if the specified burst count has not been reached.

---

**Effective and Ineffective Trigger Input for the Dual Channel Instrument.** When the operating mode for the channels has been set to either triggered mode or burst mode with a finite number of burst count, the next waveform output is started by the trigger signal after waveform output has ended on both channels. See the figure on the left below; the trigger goes on at the odd numbers.

When the operating mode for only one of the channels has been set to CONT mode or burst mode with an infinite number of burst count, the next waveform output for the other channel will be started by the trigger signal after the previous waveform output has finished. Channel output in CONT mode or burst mode with an infinite number of burst count will not be affected by the trigger once waveform output has begun. See the figure on the right below.

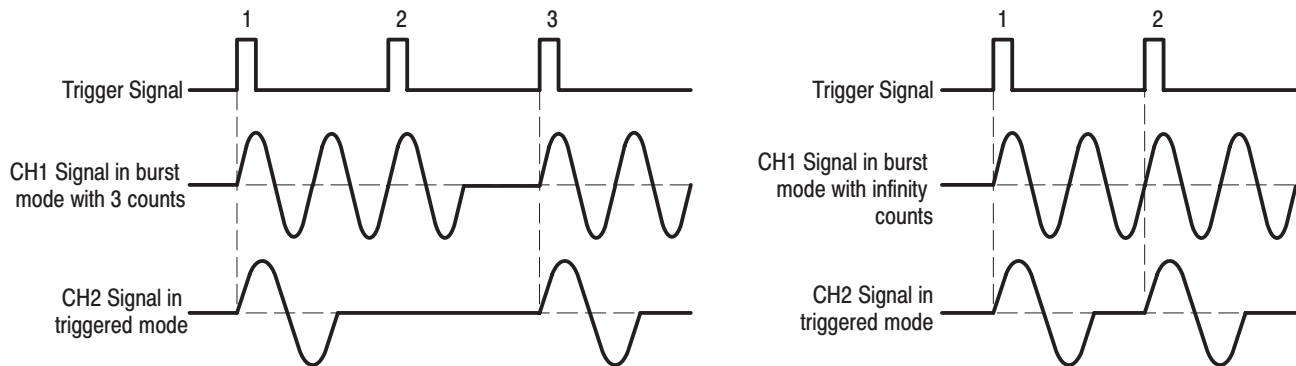

**Figure 3-11: Timing Chart of Dual Channel Instrument**

### **MODE-PARAMETER Button**

(SHIFT → MODE)

The burst count is set in the MODE-PARAMETER menu.

The burst count is a setting that specifies for how many cycles the waveform is output each time a trigger event occurs. When BRST is selected with the setting menu MODE item, the waveform will be output for the number of cycles set with this menu. The default setting is 10 cycles.

The burst count can be set to either a value between 1 and 60,000 or INF (infinity). INF is selected by pressing the SHIFT button and the +/- key in that order.

### **MODUL Button**

The MODUL button selects the modulation function to be OFF or the type of modulation to be one of four modulations: SWP, FM, FSK, or AM. OFF is the default setting.

The modulation parameter can be set in advance using the modulation parameter menu (MODUL-PARAMETER menu) so that the desired modulation is acquired.

**SWP (Sweep).** The sweep function outputs a waveform with the output signal frequency varying linearly or logarithmically.

The modulation parameter menu includes items for setting the sweep start frequency, sweep stop frequency, sweep time and the sweep shape.

When a sweep function is selected, the frequency set by the setting menu FREQ item is ignored, and the frequency is swept from the sweep start to the sweep stop frequencies. Depending on which of the start and stop frequencies is larger, the frequency can be swept from low frequencies to high frequencies or in the reverse direction.



In triggered mode, the instrument performs a sweep each time a trigger is applied. In burst mode, the instrument performs the number of sweeps specified by the burst count each time a trigger is applied.

**FM (FM Modulation).** Frequency modulation is a modulation technique in which the carrier frequency is modified by the amplitude of the modulating wave.

The modulation parameter menu includes items for setting the modulating wave type, the modulating wave frequency, and the frequency deviation.

The setting menu FUNC, FREQ, and AMPL items set the carrier wave waveform, center frequency, and amplitude.

In triggered mode, modulated output for one period of the modulating wave is output each time a trigger is applied. In burst mode, the number of periods specified in the burst count of the modulating wave is output each time a trigger is applied.

**FSK (FSK Modulation).** Frequency shift keying modulation is a modulation technique that shifts the output signal frequency between two frequencies: the carrier frequency and the FSK frequency.

The modulation parameter menu includes items for setting the FSK frequency and the FSK rate.

The setting menu FUNC, FREQ, and AMPL items set the carrier wave waveform, center frequency and amplitude.

In triggered mode, modulated output for one period of the frequency deviation is output each time a trigger is applied. In burst mode, the number of periods specified in the burst count of the frequency deviation is output each time a trigger is applied.

**AM (AM Modulation).** Amplitude modulation is a modulation technique in which the amplitude of the carrier frequency is modified by the amplitude of the modulating wave.

The modulating wave is input from the AM IN connector on the rear panel. A 100% modulated signal is acquired when a  $2 V_{p-p}$  (tolerance:  $\pm 0.2 V$ ) modulating signal is provided. When there is no modulating input, the carrier frequency amplitude will be one half the value set with the setting menu AMPL item.

The setting menu FUNC, FREQ, and AMPL items set the carrier wave waveform, center frequency and amplitude.

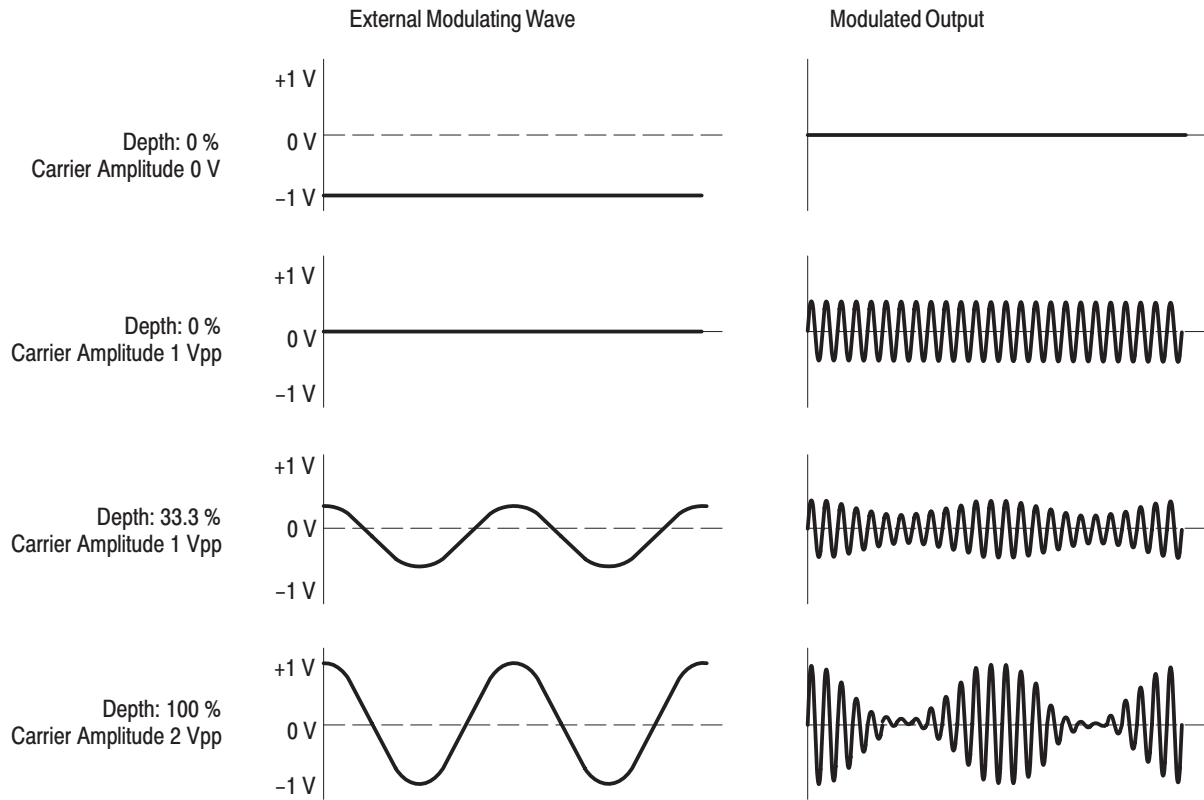

**Figure 3-12: Relationship between External Modulating Wave and AM Modulated Output**

## MODUL-PARAMETER Button

(SHIFT → MODUL)

The PARAMETER-MODUL button selects the following modulation parameters: sweep parameters, FM modulation parameters, and the FSK modulation parameters.

The sweep parameters consist of the sweep start frequency, the stop frequency, the sweep time, and the sweep shape. When SWP has been selected with the setting menu MODUL item, the instrument outputs a sweep waveform defined by the parameters set in this MODUL-PARAMETER menu.

The FM modulation parameters consist of the modulating wave type, the modulating wave frequency, and the frequency deviation. When FM has been selected with the setting menu MODUL item, the instrument outputs a FM modulated waveform defined by the parameters set in this menu.

The FSK modulation parameters consist of the hop frequency and the FSK rate. When FSK has been selected with the setting menu MODUL item, the instrument outputs a FSK modulated waveform defined by the parameters set in this menu.

---

**NOTE.** *If the parameter values are modified in a state where either a modulation function or sweep from the MODUL menu has been turned on, the modification will take a noticeable amount of time. We recommend modifying parameter values with the MODUL item setting temporarily turned off.*

---

**SWP START (Sweep Start Frequency).** The SWP START item sets the frequency at the sweep start. The default frequency setting is 1 kHz.

When sweep is taking place, the frequency sweeps from the SWP START frequency to the SWP STOP frequency and then returns to the SWP START frequency. Refer to Figure 3–13.

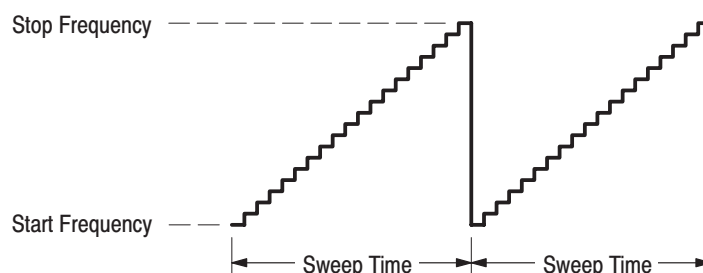

**Figure 3–13: Frequency Sweep in Case of “START < STOP”**

The instrument sweeps from a low frequency to a high frequency when the SWP START frequency is set to be lower than the SWP STOP frequency (SWP START < SWP STOP).

The instrument sweeps from a high frequency to a low frequency when the SWP START frequency is set to be higher than the SWP STOP frequency.

Frequencies have a resolution of 10 mHz or five digits. The highest frequency allowed differs for different waveforms. Refer to Table 3–1 on page 3–10.

**SWP STOP (Sweep Stop Frequency).** The SWP STOP item sets the frequency at the sweep stop. The default frequency setting is 100 kHz.

See the description of the start frequency for details on the sweep stop frequency range and characteristics.

**SWP TIME (Sweep Time).** This item sets the time taken by the sweep from the start frequency to the stop frequency. Refer to Figure 3–13 .

The sweep time can be set to a value in the range 1 ms to 100 s with a resolution of four digits or 1 ms. The default sweep time setting is 1.000 s.

**SWP SPACING (Sweep Spacing).** The sweep frequency variation can be selected to be either LINEAR or LOG.

The sweep output frequency changes in a stepwise manner. When LINEAR is selected, the change in the frequency for a single step is a fixed value. When LOG is selected, the frequency changes logarithmically with each step.

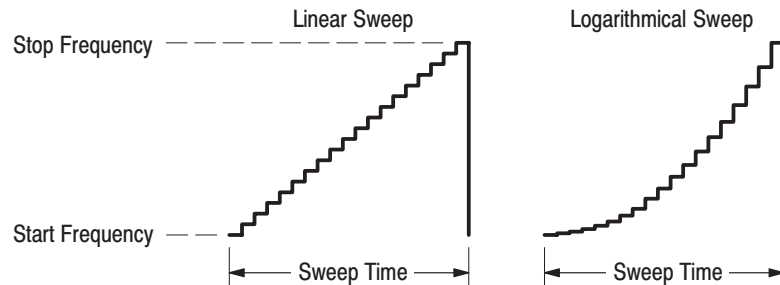

**Figure 3-14: Spacing Type**

**FM FUNC (FM Modulating Waveform.)** The FM FUNC item selects a modulating waveform: a standard waveform, a waveform defined by the user and stored in memory, or the waveform written to edit memory. SINE is the default setting.

There are four standard waveforms: sine, square, triangle, and ramp.

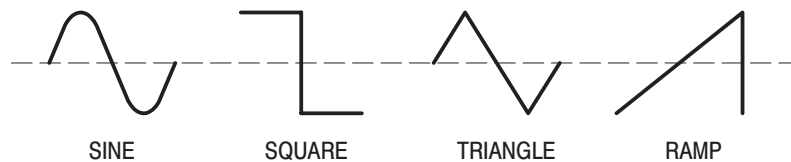

User waveforms must first be created using the edit menu and then stored in user waveform memory, which has four locations: USER1, USER2, USER3, and USER4. Also, the waveform being edited using the edit menu can be a modulating waveform by selecting EDIT MEMORY.

**FM FREQ (FM Modulating Waveform Frequency).** The FM FREQ item sets the frequency of the modulating waveform. The default frequency setting is 1 kHz. The frequency can be set to a value in the range 10 mHz to 10 kHz with a frequency resolution of 4 digits or 10 mHz.

**FM DEVI (Frequency Deviation for the FM Modulation).** The frequency deviation expresses the amount of deviation from the carrier frequency. The default frequency is 10 kHz.

The valid range for the frequency setting depends on the waveform selected as the carrier as listed in Table 3–3. Frequencies have a resolution of 10 mHz or seven digits.

**Table 3–3: Setting Range for the Frequency Deviation**

| <b>FUNC Waveform</b> | <b>Minimum Frequency</b> | <b>Maximum Frequency</b> |
|----------------------|--------------------------|--------------------------|
| SINE                 | 10 mHz                   | 8 MHz                    |
| SQUA                 | 10 mHz                   | 8 MHz                    |
| TRIA                 | 10 mHz                   | 50 kHz                   |
| RAMP                 | 10 mHz                   | 50 kHz                   |
| USER1 ~ USER4        | 10 mHz                   | 800 kHz                  |
| EDIT                 | 10 mHz                   | 800 kHz                  |

**NOTE.** *The maximum frequency for user and edit waveforms are restricted according to the number of points that make up the waveform. User and edit waveforms with 10 points have a maximum frequency of 800 kHz.*

The valid range for the deviation frequency setting is restricted in a manner that depends on the frequency of the carrier. If the deviation frequency is changed in a manner that does not fulfill the following conditions, the set value will automatically be changed to the limiting value:

- The sum of the deviation frequency ( $f_{\text{devia}}$ ) and the carrier frequency ( $f_{\text{carri}}$ ) must be lower than the maximum frequency ( $f_{\text{max-carri}}$ ) that the carrier can be set to.

$$f_{\text{devia}} + f_{\text{carri}} \leq f_{\text{max-carri}}$$

- The deviation frequency ( $f_{\text{devia}}$ ) must be lower than the carrier frequency ( $f_{\text{carri}}$ ).

$$f_{\text{devia}} \leq f_{\text{carri}}$$

**FSK RATE (Frequency Shift Rate).** The shift rate is expressed as the reciprocal of the time with which the frequency switches between the carrier frequency and the FSK frequency.

The default shift rate (frequency) is 1 kHz. The shift rate can be set to a value in the range 10 mHz to 50 kHz with a resolution of four digits or 10 mHz. The shift rate, however, cannot be set to a value exceeding carrier frequency.

**FSK FREQ (Hop Frequency).** The FSK FREQ item sets the hop frequency. The default frequency setting is 10 kHz. The frequency can be set to a value in the range 10 mHz to 16 MHz. However, The highest frequency allowed differs for different waveforms. (Refer to Table 3–1 on page 3–10.) Frequencies have a resolution of 10 mHz or seven digits.

In FSK modulation, the output signal frequency switches between two frequencies: the carrier frequency and the FSK frequency. See Figure 3–15.

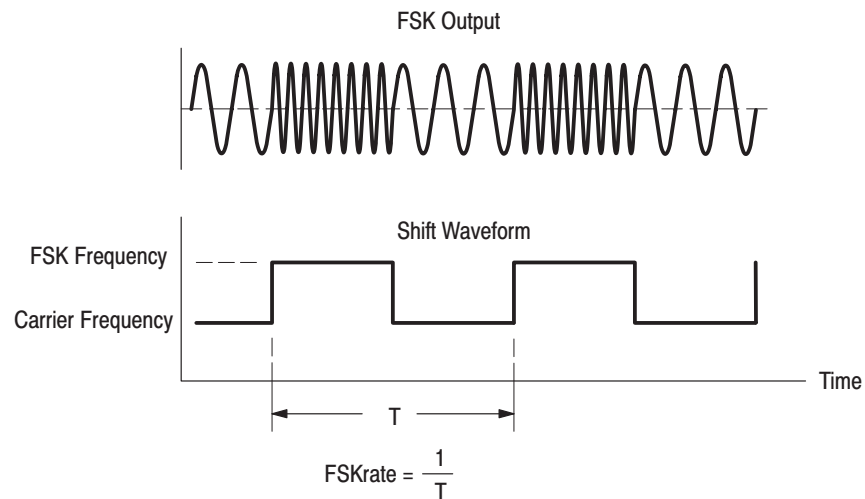

**Figure 3-15: FSK Modulation**

### **EDIT Button** (SHIFT → OFFSET)

To output a user waveform using this instrument, a waveform must first be created in edit memory and then stored in user waveform memory. Although a waveform in edit memory can be output, edit memory is erased when the power is turned off.

There are three techniques for creating a waveform in edit memory: creating a waveform using edit menu, transferring a waveform from a controller using GPIB commands, and importing a waveform from a DSO (digital storage oscilloscope).

To select the edit menu, press the EDIT button. (Press the SHIFT button and then the OFFSET button in that order.)

The edit menu supports eight edit functions in addition to functions for waveform import and storage. The edit menu items are described below.

**NUM OF POINTS (Number of Points).** This menu item sets the number of points of waveform to be created or the length of edit memory. The power on default point setting is 1000. The points can be set to a value in the range 10 to 16,384.

If a waveform is already written to edit memory and this item is set to a value smaller than the number of points in that waveform, then the data for the points starting at that value plus one will be lost. For example, if this item is set to 500 in the state where a waveform with 1000 points has been written to edit memory, the waveform data for points 1 to 500 will remain without change but the data from point 501 will be lost. Refer to Figure 3–16.

If a waveform is already written to edit memory and this item is set to a value greater than the number of points in that waveform, then the data from the point starting at that value plus one to the point set by newly input will be set to the zero level (decimal code value: 2047). For example, if this item is set to 1500 in the state where a waveform with 1000 points has been written to edit memory, the waveform data for points 1 to 1000 will remain without change and the data from point 1001 to point 1500 will be set to 2047 in decimal code value. Refer to Figure 3–16.

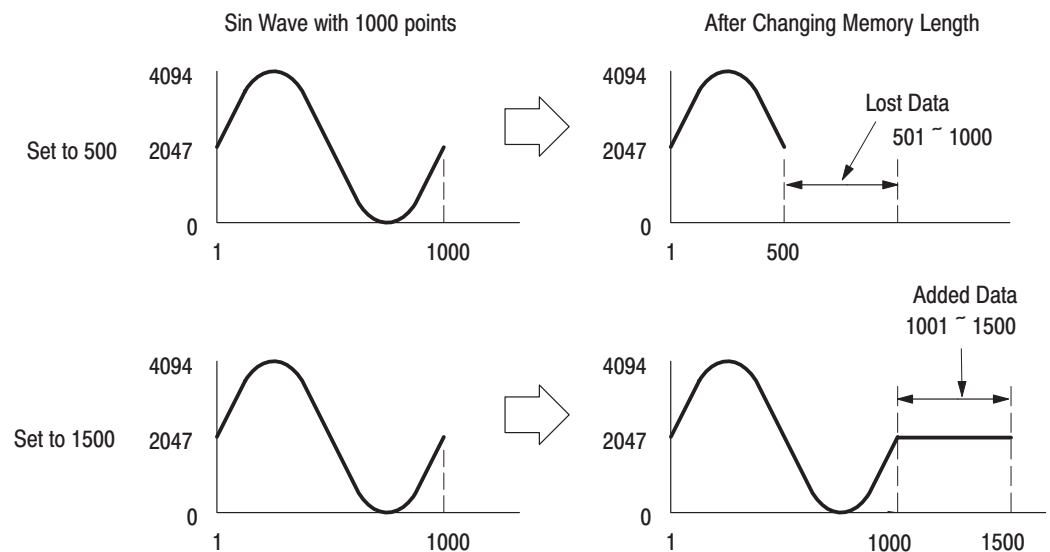

**Figure 3–16: Add or Delete Data by Changing Number of Points**

**NEW (Write a New Waveform).** This menu item writes a standard waveform to edit memory. The written waveform has the number of points specified with the NUM OF POINTS item and starts at waveform point number one. One of five waveform types (sine, square, triangular, ramp and noise) can be selected as the standard waveform.

If a waveform is already stored in edit memory, that waveform data will be lost, i.e. Since the new waveform overwrites the old data.

**COPY FROM (Copy a Waveform from User Waveform Memory).** This menu item copies one of the USER1 to USER4 user waveforms to edit memory. When the copy is executed, the edit waveform is overwritten and the NUM OF POINTS setting is automatically modified to the user waveform length.

**APPEND (Append a Waveform at the End of the Edit Waveform).** This menu item appends the contents of user memory (USER1, USER2, USER3, or USER4) or the current contents of edit memory (EDIT MEMORY) to the end of the waveform currently being edited.

When the waveform append operation is executed, the NUM OF POINTS setting is automatically modified. If the waveform append operation would cause the waveform to exceed 16,384 points, the waveform append will not be executed. Refer to Figure 3–17.

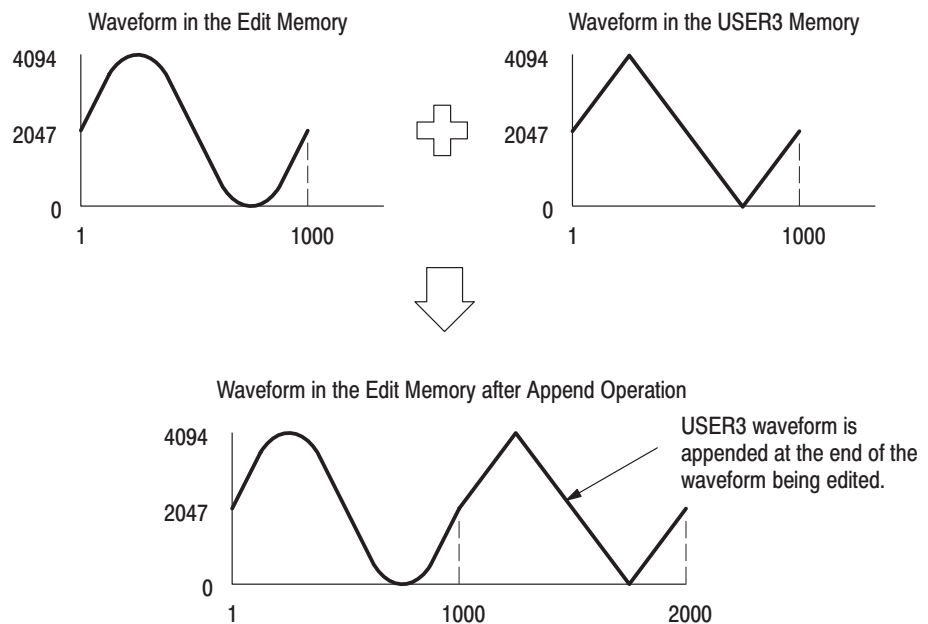
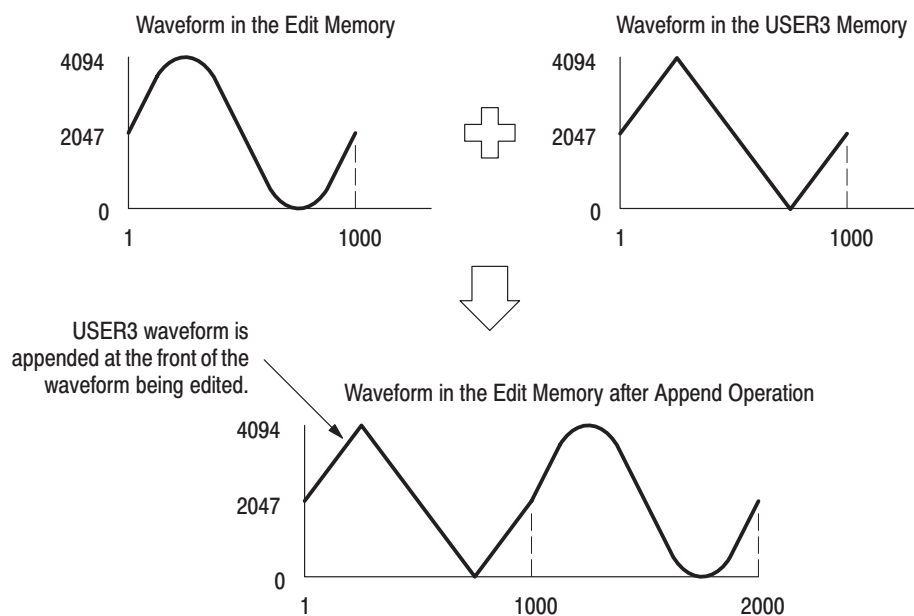

**Figure 3-17: Append a Waveform at the End of the Edit Waveform**



**PREPEND (Append a Waveform at the Front of the Edit Waveform).** This menu item appends the contents of user memory (USER1, USER2, USER3, or USER4) or the current contents of edit memory (EDIT MEMORY) at the front of the waveform currently being edited.

When the waveform append operation is executed, the NUM OF POINTS setting is automatically modified. If the waveform append operation would cause the waveform to exceed 16,384 points, the waveform append will not be executed. Refer to Figure 3–18.

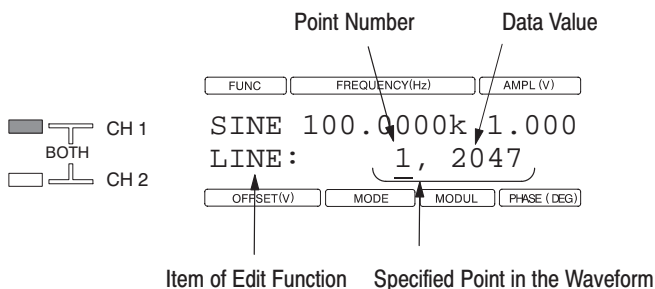

**Figure 3–18: Append a Waveform to the Front of the Edit Waveform**

**LINE (Line Editing).** This function edits by linearly interpolating from a specified point in the waveform currently being edited to another specified point.

When a line edit function is selected and confirmed, two numbers are shown, and the cursor will be displayed on the number on the left.

The two numbers are delimited by a comma. The number on the left is the number of the point in the waveform and the number on the right is the data value for that point number. Refer to Figure 3–19.



**Figure 3–19: LCD Display When LINE Item is Selected and Confirmed**

Data is entered as an integer in the range of 0 to 4094 in decimal code. The value 2047 corresponds to the 0 level.

It is not possible to specify a number that exceeds the number of points in the current waveform.

The line edit function requires two or more points to be modified. If you exit from the line edit function after changing the value of only one point, the line edit will not be executed.

The linear interpolation between the points is executed when the second point and the following values are confirmed with the ENTER key. Refer to Figure 3–20.

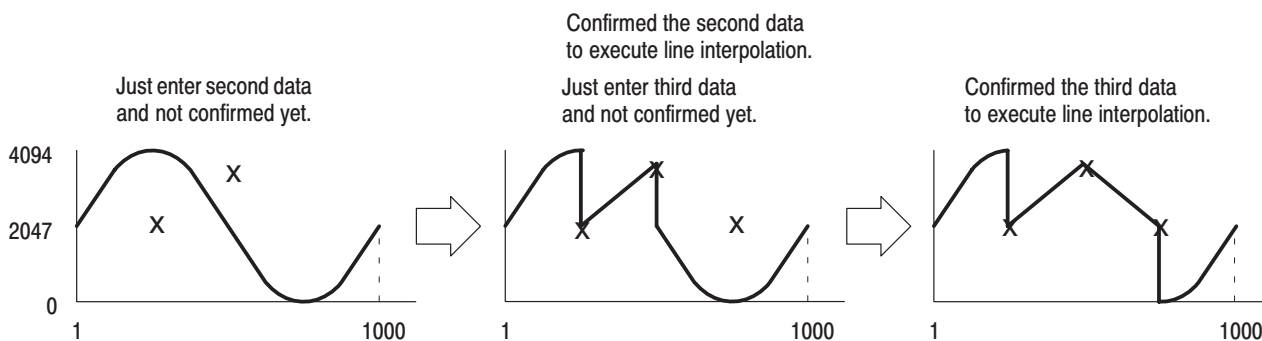

**Figure 3–20: Example of LINE Editing on the Three Points**

**DATA (Editing by Data Point).** This function edits a specified point in the waveform currently being edited.

When a data edit function is selected and confirmed, two numbers are shown and the cursor will be displayed on the number on the left.

The two numbers are delimited by a comma. The number on the left is the number of the point in the waveform and the number on the right is the data value for that point number.

Data is entered as an integer in the range 0 to 4094 in decimal code. The value 2047 corresponds to the 0 level.

It is not possible to specify a number that exceeds the number of points in the current waveform.

The data edit will be executed when data value of a point number is confirmed with the ENTER key.

**CUT (Cut Data Points on the Designated Range).** This function deletes an area between specified points in the waveform.

When the cut function is selected and confirmed, two numbers are shown, and the cursor will be displayed on the number on the left.

The two numbers are delimited by a BOTH direction arrow: “<->”. The two numbers on the left and right are the first point and end point of an area to be deleted in the waveform. Refer to Figure 3–21.

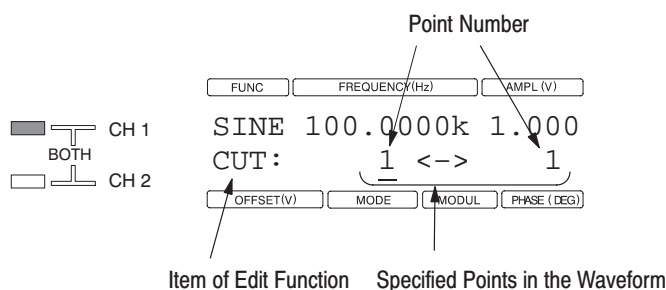

**Figure 3–21: LCD Display When CUT Item is Selected and Confirmed**

The number of points in the waveform is reduced by the data deletion. The delete operation will not be executed if there would not be at least ten points remaining.

The deletion includes the data for the specified point numbers. Refer to Figure 3–22.

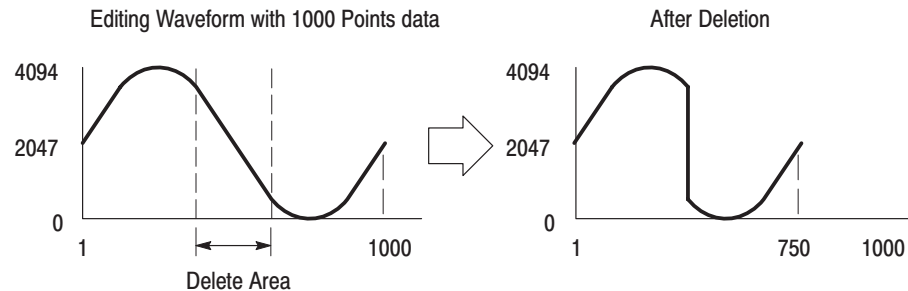

**Figure 3–22: Example of Cutting Data Between Specified Points**

---

**NOTE.** *Data that has been deleted cannot be recovered.*

---

**SAVE TO (Save the Edit Waveform to the User Waveform Memory).** The currently edited waveform is written to the edit memory. If the power is turned off at this point, the edit memory waveform will be lost. To allow this waveform to be used the next time the power is turned on, the edit memory waveform must be saved into the one of the user waveform memory.

This instrument can store up to four user waveforms. This function allows you to select one of the four user waveform memories, USER1 through USER4, and store the contents of edit memory in that memory.

The edit memory waveform cannot be stored in a locked user waveform memory. Unlock the memory with the UNLOCK WAVE item on the system menu to allow storing to that memory.

The message “\*\*\*SAVING\*\*\*” is displayed in the first line of the LCD while waveform data is being stored in nonvolatile memory.

---

**NOTE.** *Do not turn off the power while “\*\*\*SAVING\*\*\*” is displayed. If the power is turned off while this message is displayed, waveform data stored in internal waveform may be lost.*

---

**IMPORT FROM (Import a Waveform from Other Instruments).** This instrument supports the direct transfer to edit memory of waveforms acquired by a digital storage oscilloscope or created by another waveform generator through the GPIB interface without the use of a controller.

The length of the imported data must be between 10 points and 16,384 points. Only the first 16,384 points are valid in data longer than 16,384 points. Data exceeding 16,384 points will be discarded. An error occurs if there are fewer than 10 data points.

The following instruments can be selected as the waveform data source: Tektronix DSO oscilloscopes (oscilloscopes compatible with models TDS500s and 2430), AFG series function generators (model AFG2020), and any instrument in the AWG series of arbitrary waveform generators. The data source will be the waveform in memory number 1 with the AFG2020 and the CH1 waveform for all other instruments.

The system menu GPIB CONFIG item must be set to DSOLINK in advance to execute an import operation.

Any GPIB address can be used for the transfer source, and there is no need to change the GPIB address on this instrument.

When the import operation is executed, the instrument will automatically search for the connected instrument. If multiple instruments that are supported as transfer sources are connected, the instrument with the youngest GPIB address number will be selected.

An error will occur if a system controller is connected in the same system.

### **SAVE Button** (SHIFT → RECALL)

When power is turned on, the instrument goes to the power on initial state and does not restore the settings that were in effect when the power was turned off. However, it is possible to save the settings just before turning the instrument off or to save the commonly used settings in the internal nonvolatile memory and use those settings again the next time the instrument is turned on.

Up to 20 setting states, which include input values and items selected in the settings menu (such as waveform type, frequency, amplitude, and operating mode) and parameter menu (such as modulation settings and sweep settings), can be saved in the internal nonvolatile memory. In the two channel model, the settings for both channels are saved.

The channel selection state and the BOTH setting cannot be saved.

When shipped from the factory, all the setting memories (nonvolatile memory) numbers 0 to 19 hold the initial settings. When saving settings, any memory number from 0 to 19 can be used. When a save operation is executed, the previous contents are overwritten.

The message “\*\*\*SAVING\*\*\*” is displayed in the first line of the LCD while setting data are being stored in nonvolatile memory.

---

**NOTE.** Do not turn off the power while “\*\*\*SAVING\*\*\*” is displayed. If the power is turned off while this message is displayed, setting data stored in internal waveform may be lost.

---

**How to Save Settings for Matching the Step Recall.** Setting the instrument to step recall mode allows the saved settings to be recalled in order by first pressing the RECALL button and then pressing the ENTER button repeatedly. In this mode, the instrument loops from number 0 to the number set with the LAST RECALL STEP item. Refer to *RECALL Button* on page 3–30 for details on the step recall mode.

Remember the following points when saving settings:

- Store the desired settings in recall order starting with memory number 0.
- A given memory will hold the initial settings, even if the settings are not explicitly stored. *Initial Settings* on page E–2 for details.
- The last memory to be recalled in step recall is specified with the LAST RECALL STEP item in the system menu.

## RECALL Button

This button recalls settings saved with the SAVE button or the initial settings saved as the default and sets up the instrument. There are two recall techniques: normal recall, in which a specified memory number is recalled, and step recall, in which the memory number is changed automatically in sequence.

When shipped from the factory or SECURE (Executing Factory Reset), all the setting memories (nonvolatile memory) numbers 0 to 19 hold the initial settings. See *Secure Settings (Factory Settings)* on page E–4 for details.

The features of these modes are described below.

**Normal Recall Mode.** In this mode, the user specifies the memory number to recall stored settings.

Normally, three steps are required to recall settings: pressing the RECALL button, entering the desired memory number, and then pressing the ENTER button.

Thereafter, settings can be recalled repeatedly by entering the desired memory number and pressing the ENTER button.

**Step Recall Mode.** Step recall mode is the mode in which the saved settings are recalled by pressing the ENTER button repeatedly after once pressing the RECALL button. In this mode, the instrument loops from number 0 to the number set with the LAST RECALL STEP item.

To use step recall mode, turn on the STEP RECALL item in the SYSTEM menu. Also, set the last memory number to be recalled with the LAST RECALL STEP item in the SYSTEM menu.

The first memory recalled is recalled in the same manner as in normal recall mode, by entering the number and confirming that number with the ENTER key.

If the first memory recalled is smaller than the number specified in the LAST RECALL STEP setting, the memory number is increased at the same time the recall operation is executed.

If the first memory recalled is equal to or larger than the number specified in the LAST RECALL STEP setting, the memory number is reset to zero at the same time the recall operation is executed.

From here on, the instrument will recall a memory number and increment the memory number each time the ENTER button is pressed.

Step recall mode allows the settings in a desired memory to be recalled by changing the number of the next memory to be recalled.

The examples below show the recall order when the LAST RECALL STEP item is set to 5.

- Begin with 3 ( the first memory recalled < LAST RECALL STEP)

3 → 4 → 5 → 0 → 1 → 2 → 3 → 4 → 5 → 0 → 1 . . . . .

- Begin with 9 (the first memory recalled  $\geq$  LAST RECALL STEP)

9 → 0 → 1 → 2 → 3 → 4 → 5 → 0 → 1 → 2 → 3 . . . . .

## **SYSTEM Button** (SHIFT → PHASE)

The system menu organizes system related items, including GPIB setup, the step recall mode on/off setting, the key click and beep sound on/off settings, the user waveform memory lock/unlock settings, firmware version display and diagnostic and calibration execution.

To select the system menu, press the SYSTEM button, (press the SHIFT button and then the PHASE button in that order).

The system menu item and numeric value or selection for that item will be displayed in the second line of the LCD.

Since the selections and values set with the system menu are stored in nonvolatile memory, these settings are not reinitialized by turning the power off and on again or by executing the initialization procedure.

---

**NOTE.** When the secure function is executed, all the data stored in nonvolatile memory are initialized, restoring the instrument to the factory settings.

---

The message shown below is displayed in the first line of the LCD while selections and values are being stored in nonvolatile memory. Also note that “\*\*\*CALIBRATING\*\*\*” is displayed during calibration and “\*\*\*INITIALIZING\*\*\*” during initialization.



---

**NOTE.** Do not turn off the power while “\*\*\*SAVING\*\*\*”, “\*\*\*CALIBRATING\*\*\*”, or “\*\*\*INITIALIZING\*\*\*” is displayed. If the power is turned off while one of these messages is being displayed, data stored in internal nonvolatile memory may be lost.

---

**GPIB ADDRESS (Setting GPIB Address).** This instrument can be controlled remotely by a computer over an IEEE STD 488-1987 compliant interface. Refer to *Remote Interface* on page 4–1 for details on the GPIB interface.

The GPIB address can be set to values in the range of 0 to 30. Other instruments on the bus cannot use the address number allocated to this instrument.

- **GPIB CONFIG (Setting GPIB Configuration).** This instrument supports three GPIB configuration settings: Talk/Listen, Linked to DSO, and Off Bus.
- **T / L (Talk / Listen).** This instrument must be set to the talk/listen state to communicate with the controller over the GPIB interface. When the T/L item is selected, the operating mode for communication between this instrument and other devices is set to talk/listen.
- **DSOLINK (Linked to DSO).** To directly import waveforms without using the controller, the DSOLINK item from this menu must be selected. Furthermore, the waveform data source instrument (TDS, AFG, or AWG) must be selected using the IMPORT FROM item in the EDIT menu.



**OFF BUS (Off Bus).** Selecting the OFF item disconnects this instrument from the bus.

**STEP RECALL (Setting On / Off State for the Step Recall Mode).** This item sets the step recall mode to on/off state.

This instrument can save up to 20 setup states in nonvolatile memory. Normally, three steps are required to recall these settings: pressing the RECALL button, entering the memory number, and then pressing the ENTER button.

However, setting the instrument to step recall mode allows these settings to be recalled in order by first pressing the RECALL button and then pressing the ENTER button repeatedly. In this mode, the instrument loops from number 0 to the number set with the LAST RECALL STEP item.

**LAST RECALL STEP (Specify the Last Setting Memory Number for the Step Recall).**

This item specifies the last setting memory number to be recalled when using step recall mode for recalling settings. This item can be set to a value between 1 and 19, inclusive. This means that the minimum number of steps in step recall is two steps.

When the settings from the memory number specified as the last recall step have been recalled, the settings from memory number 0 will be recalled the next time the ENTER button is pressed.

**KEY CLICK and BEEP (On/Off Setting for Key Click and Beep Sound).** These items determine whether or not click or beep sounds are emitted when a front panel key/button is pressed.

Table 3–4 lists the sounds emitted in response to valid and invalid key/button presses, according to the combination of the click on/off and beep on/off settings.

**Table 3–4: Combination of Key Click and Beep**

| Setting   |      | Sound When Pressing Button |         |
|-----------|------|----------------------------|---------|
| KEY CLICK | BEEP | Valid                      | Invalid |
| ON        | ON   | Click                      | Beep    |
| ON        | OFF  | Click                      | Click   |
| OFF       | ON   | Silence                    | Beep    |
| OFF       | OFF  | Silence                    | Silence |

For example, when the both the KEY CLICK and BEEP settings are on, the instrument will emit a click when a valid key/button is pressed and a beep when an invalid key/button is pressed.

Valid key/button operations consist of selecting a key/button whose operation is possible, such as changing a selection, changing a value, selecting a menu item, or selecting another main menu from within the currently active menu layer. These operations result in the LCD display changing, the cursor moving, or a value changing.

Invalid key/button operations consist of selecting a key/button whose operation is impossible within the currently active menu layer. These operations do not result in the LCD display changing, the cursor moving, or a value changing.

**LOCK WAVE (Lock User Waveform Memory).** The LOCK WAVE item locks the specified user waveform memory. Waveforms can no longer be written to the user waveform memory once it is locked.

Once the LOCK WAVE item selection has been confirmed, the user waveform memories displayed by the  $\vee$  and  $\wedge$  buttons are memories that currently have no lock applied.

After selecting a user waveform memory with the  $\vee$  and  $\wedge$  buttons, pressing the ENTER key locks that memory. When a memory is locked, the name of that user waveform memory is removed from this selection set. The removed user waveform memory name is added to the selections for the UNLOCK WAVE item.

**UNLOCK WAVE (Unlock User Waveform Memory).** The UNLOCK WAVE item unlocks the specified user waveform memory. Waveforms can be written to the unlocked user waveform memory.

Once the UNLOCK WAVE item selection has been confirmed, the user waveform memories displayed by the  $\vee$  and  $\wedge$  buttons are memories that currently have lock applied.

After selecting a user waveform memory with the  $\vee$  and  $\wedge$  buttons, pressing the ENTER key unlocks that memory. When a memory is unlocked, the name of that user waveform memory is removed from this selection set. The removed user waveform memory name is added to the selections for the LOCK WAVE item.

**COPY CH1  $\rightarrow$  2 (Copy CH1 Parameter to CH2).** This function copies all the parameter values for channel 1 into channel 2. This function is available for dual channel instruments.

Here, “all the parameter values” refers to the values of the setting menu items (FUNC, FREQ, AMPL, OFFSET, PHASE, MODE, and MDUL) and the

parameter menu items (FUNC-PARAMETER, MODE-PARAMETER, and MODUL-PARAMETER).

**INITIALIZE (Executing Initialization.)** This function initializes all the parameter values of the setting menu items and parameter menu items.

The following items are not initialized by the initialization procedure. However, the power on initialization includes the first three items in the following list. Refer to *Initial Settings* on page E-2 for details on the initial settings.

- The menu item selection states and the cursor position
- The edit menu data
- The edit menu item settings
- The data stored in nonvolatile memory (setting memory data, user waveform memory data, and system menu item settings)

To perform the initialization, after the INITIALIZE item selection is confirmed, press the ENTER button.

To cancel initialization execution after the INITIALIZE item selection has been confirmed, press the front panel EXIT/CANCEL button to exit from the selection menu level.

---

**NOTE.** *The CANCEL button does not restore the previous settings after the initialization procedure has been executed.*

*This initialization operation differs slightly from the power on initialization. The power on initialization initializes everything except the nonvolatile memory data.*

---

**SECURE (Executing Factory Reset).** This function initializes all the instruments setting items, edit memory data, and settings and data stored in nonvolatile memory, thus restoring the instrument to the factory settings. However, the instruments internal calibration data is not changed. See *Secure Settings* on page E-4 for details.

To perform the secure, after the SECURE item selection is confirmed, press the ENTER button.

To cancel secure execution after the SECURE item selection has been confirmed, press the front panel EXIT/CANCEL button to exit from the selection menu level.

**NOTE.** The CANCEL button does not restore the previous settings after the secure procedure has been executed.

**VERSION (Display Firmware Version).** Display the firmware version number by selecting VERSION item. This item is display only. It is not necessary to confirm this item for display.

**SELF TEST (Executing Self Test).** This instrument includes a diagnostic system that performs comprehensive tests of the instrument’s functions. This system checks to see if the instrument is operating correctly. Some of the tests are executed automatically when the instrument is turned on. These diagnostics can be helpful when repairing the instrument.

When an error is detected during diagnostic execution, the instrument displays the name of that test item. If the diagnostics complete without finding any problems, the display returns to its state before the diagnostics were executed.

If multiple errors were detected, the test item names can be viewed using the  $\vee$  and  $\wedge$  buttons.

Press the front panel EXIT/CANCEL button to exit from the error display state.

**NOTE.** Waveform output acquired from an instrument that does not pass all the diagnostic tests is not reliable. If errors were detected, consult the distributor where you have purchased this instrument about details concerning warranty and service.

Figure 3–23 shows an example of an LCD display when an error was detected.

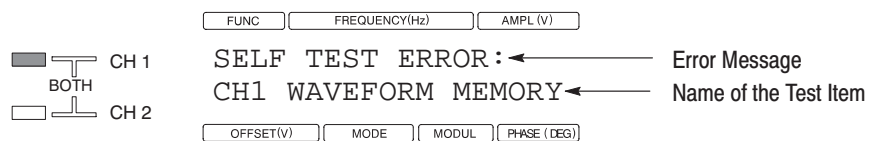

**Figure 3–23: Error Display When Errors Were Detected**

**CALIBRATION (Executing Calibration).** This instrument includes a system that performs instrument calibration. This system allows the instrument to operate with correct precision.

---

**NOTE.** *The calibration must be executed at an ambient temperature of between +20 and +30°C, when a warm-up period of about 20 minutes has passed, and with the instrument stable. Calibration data in memory may be lost if the instrument's power is turned off during calibration system execution.*

---

If the calibration completes correctly, the calculated calibration data is automatically stored in nonvolatile memory and the display returns to its state before calibration was executed.

If any errors were detected, the result of the item that caused the error is not saved. Also, the name of that item will be displayed on the LCD.

If multiple errors were detected, the calibration item names can be viewed using the  $\vee$  and  $\wedge$  buttons.

Press the front panel EXIT/CANCEL button to exit from the error display state. Although the instrument will then operate normally, the output cannot be guaranteed since the default value of the calibration data for the item that caused the error will be used for system control.

Figure 3–24 shows an example of an LCD display when an error was detected.

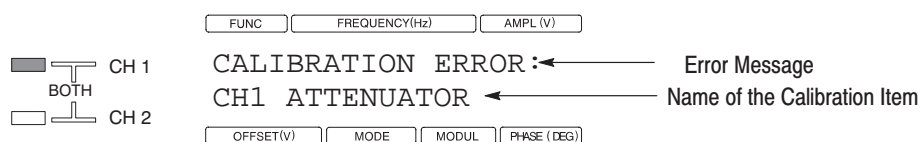

**Figure 3–24: Error Display When Errors Were Detected**



# Syntax and Commands

This section provides the following information:

- *Installing a GPIB Connection* describes how to connect and set up for remote operation.
- *Syntax* defines the command syntax and processing conventions.
- *Command Groups* describes command groups which lists the commands by function.
- *Command Descriptions* describes the notation of each of the commands in alphabetical order.
- *Examples* describes the example programs that you can use to control the Arbitrary Function Generator over the GPIB interface.

## Remote Interface

The Arbitrary Function Generators are equipped with a GPIB interface port. Through this interface, it is possible to operate menus and front panel controls on the instrument from an external controller using the special programming command set. (The exceptions are some edits and GPIB parameter setting functions and the operation of the POWER switch on the front panel.)

This section will describe the methods used to control the instrument through the GPIB interface.

### Installing a GPIB Connection

With the power off, connect a GPIB cable from the GPIB controller to the ANSI/IEEE Std 488 port (GPIB) connector on the rear panel of the Arbitrary Function Generator. Refer to Figure 4–1.

For example, when using an MS-DOS compatible controller, connect the GPIB cable between the National Instrument PC2A GPIB board and the GPIB connector on the Arbitrary Function Generator.

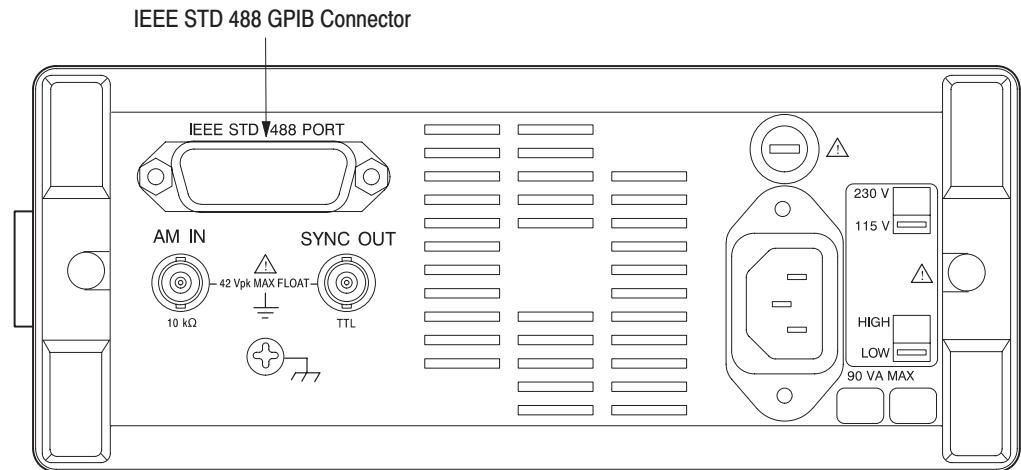

**Figure 4-1: IEEE STD 488 Port**

Instruments can be connected to the GPIB in linear or star configurations or in a combination of both configurations. A linear hookup is one where a GPIB cable is used to string one device to a second, and then another GPIB cable is used to string from a second to a third, and so on until all devices in the system are connected. A star setup is one where one end of all the GPIB cables in the system is attached to the same device. Refer to Figure 4-2 for the GPIB system configurations.

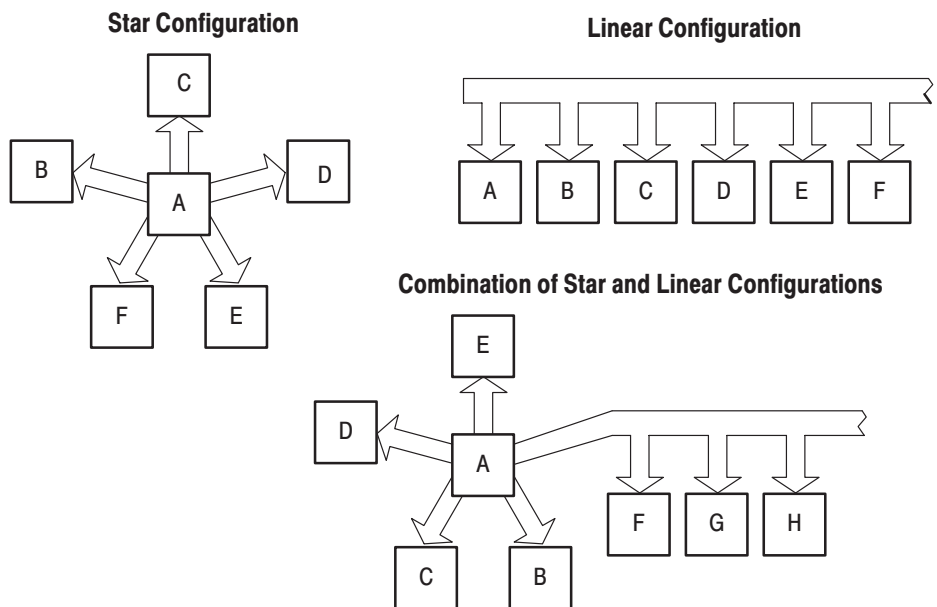

**Figure 4-2: GPIB System Configurations**



## Setting the GPIB Parameters

Follow the steps below to access the GPIB parameters. Set values are stored in the internal nonvolatile memory.

1. Set the primary address for the GPIB interface.

| Main Button  | Control Button or Numeric Input Key         |                                 |
|--------------|---|---------------------------------|
|              | First Level in the Menu Layers              | Second Level in the Menu Layers |
| SHIFT, PHASE | < or > for displaying GPIB ADDRESS<br>ENTER | ^ or v for displaying 1 ENTER   |
|              |   | EXIT                            |

Figure 4–3 shows an example of the LCD displaying a GPIB ADDRESS.

```

FUNC  FREQUENCY(Hz)  AMPL (V)
SINE 100.0000k 1.000
GPIB ADDRESS: 1
OFFSET(V)  MODE  MODUL  PHASE (DEG)

```

**Figure 4–3: LCD Display When GPIB ADDRESS Item is Displayed**

GPIB ADDRESS sets the primary communication address of the Arbitrary Function Generators. The address range is 0 to 30. The address number can be input using numeric input key instead of ^ and v button

2. Set the configuration for the GPIB interface.

| Main Button | Control Button or Numeric Input Key        |                                 |
|-------------|--|---------------------------------|
|             | First Level in the Menu Layers             | Second Level in the Menu Layers |
|             | < or > for displaying GPIB CONFIG<br>ENTER | ^ or v for displaying T/L ENTER |
|             |  | EXIT                            |
|             | EXIT                                       |                                 |

Figure 4–4 shows an example of the LCD displaying GPIB CONFIG.

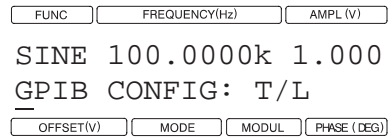

**Figure 4–4: LCD Display When GPIB CONFIG Item is Displayed**

The GPIB CONFIG item has the following selections:

- T/L: Sets the communication mode to Talk/Listen
- DSOLINK: Sets the communication mode to DSO Link to import waveform
- OFF BUS: Logically disconnects the Arbitrary Function Generator from the GPIB system

---

**NOTE.** *The Arbitrary Function Generator accepts as a terminator either the software LF (Line Feed), sent as the last data byte, or the hardware EOI, with the EOI line asserted concurrently with the last data byte sent.*

---

After these parameters are set, the GPIB interface is ready to operate and GPIB commands can be used to control the instrument remotely from an external controller.

**Operation**

Power on the instrument, and wait for the default screen to appear on the LCD display.

When powered on, the instrument can be completely controlled from the front panel. Commands are also accepted from an external controller through the remote interface. As a result, you can use either the front panel controls or the remote interfaces without having to be aware of the shift from local to remote control or from remote control to local.

## Command Syntax

This section describes the syntax and communication rules for using commands to operate the Arbitrary Function Generator. The command formats conform to standard codes, formats, and protocols as specified in ANSI/IEEE Std. 488.2-1987 and SCPI (1994.0).

### Command Notation

The command syntax is in extended BNF (Backus-Naur Form) notation. The extended BNF symbols used in the command set are shown in Table 4–1.

**Table 4–1: BNF Symbols and Meanings**

| Symbol | Meaning   |
|--------|---|
| < >    | Indicates a defined element   |
|        | Delimits Exclusive OR elements  |
| { }    | Delimits a group of elements, one of which the programmer must select                     |
| [ ]    | Delimits an optional element that the programmer may omit                                 |
| [ ]... | Delimits an optional element that the programmer may omit or may repeat one or more times |
| ::=    | Indicates that the left member is defined as shown by the the right member                |
| :      | Delimits the compound command header.   |
| ;      | Delimits between multiple commands or multiple program message units                      |
| ,      | Delimits between multiple arguments   |

### Program and Response Messages

Programs created or placed in an external controller are transferred to the Arbitrary Function Generator as a program message. A program message is a sequence of zero or more program message units delimited by the program message unit delimiter. (The semicolon character is used as the delimiter.)

A program message unit is a set command or query command. The Arbitrary Function Generator performs a function or changes a setting or mode when it receives a set command; when it receives a query command, it returns measurement data, settings, status codes and/or status messages. The Arbitrary Function Generator transfers these response messages to the external controller.

Commands are either set commands or query commands (usually referred to as commands and queries in this manual). Most commands have both a set form and query form. The query form of a command is the same as the set form, except that the query form ends with a question mark.

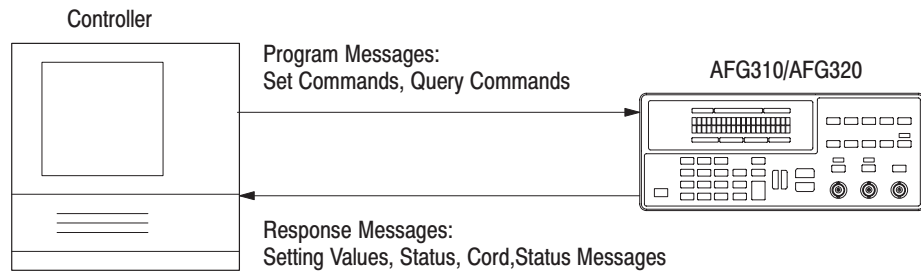

**Figure 4-5: Program Messages and Response Messages**

**Syntactic Delimiters**

Syntactic elements in a program message unit are delimited (differentiated) with colons, white space, commas, or semicolons.

**Colon (:).** Typically delimits the compound command header.

```
SOURce:FUNCtion:SHAPE
SOURce:VOLTage:OFFSet
```

**White Space.** Typically delimits command/query headers from the argument.

```
SOURce:FREQuency: 100kHz
```

In the above example, SOURce:FREQuency is the command header, and 100 kHz is the argument.

**Comma (,).** Typically delimits between multiple arguments.

```
DATA:POINts EMEMory,1000
```

In the above example, a comma delimits the multiple arguments EMEMory and 1000.

**Semicolon (;).** Typically delimits between multiple commands (or multiple program message units). For more information about using the semicolon, refer to *Concatenating Commands* on page 4–11.

**Header**

The header mnemonic represents a header node or a header subfunction. The command or query header comprises one or more header mnemonics that are delimited with the colon (:).

**Channel Representation.** In a command or query, a channel can be specified with the header mnemonics MODE<n>, OUTPut<n>, and SOURce<n>, respectively. <n> can be either 1, for channel 1, or 2, for channel 2. The MODE2, OUTPut2, and SOURce2 header mnemonics can be used only when the channel 2 output is installed.

When designating channel 1, the number “1” in the header mnemonic may be omitted. “SOURce1” itself in the SOURce<n> header mnemonic may be omitted as well.

**Header Structure.** Commands and queries can be structured into six basic forms:

- Simple command header
- Simple query header
- Compound command header
- Compound query header
- Common command header
- Common query header

Each of the six basic forms are explained below.

**Simple Command Header.** A simple command header is a command that contains only one header mnemonic. It may also contain one or more arguments. Its message format is:

```
[:]<Header Mnemonic> [<Argument>[,<Argument>]...]
```

such as:

```
MODE<n> CONTInuous
```

**Simple Query Header.** A simple query header is a command that contains only one header mnemonic followed by a question mark (?). Its message format is:

```
[:]<Header Mnemonic>? [<Argument>[,<Argument>]...]
```

such as:

```
OUTPut<n>?
```

**Compound Command Header.** A compound command header is a command that contains multiple header mnemonics plus argument(s). Its message format is:

```
[:]<Header Mnemonic>[:<Header Mnemonic>]...  
[<Argument>[,<Argument>]...]
```

such as:

```
:FM:INTernal:FUNctIon SINusoid
```

where:

:FM:INTernal:FUNctIon are multiple header mnemonics, and SINusoid is argument.

**Compound Query Header.** A compound query header is a command that contains multiple header mnemonics followed by a question mark (?). Its message format is:

```
[:]<Header Mnemonic>[:<Header Mnemonic>]...?
[<Argument>[,<Argument>]...]
```

such as:

```
MODE<n>:BCOunt?
```

**Common Command Header.** A common command header is a command that precedes its header mnemonic with an asterisk (\*). Its message format is:

```
<Header Mnemonic> [<Argument>[,<Argument>]...]
```

such as:

```
*CLS
```

The common commands are defined by IEEE Std 488.2 and are common to all devices which support IEEE Std 488.2 on the GPIB bus.

**Common Query Header.** A common query header is a command that precedes its header mnemonic with an asterisk (\*) and follows it with a question mark (?). Its message format is:

```
<Header Mnemonic>? [<Argument>[,<Argument>]...]
```

such as:

```
*IND?
```

The common commands are defined by IEEE Std 488.2 and are common to all devices which support the IEEE Std 488.2 on the GPIB bus.

## Arguments

In a command or query, one or more arguments follow the command header. The argument, sometimes called program data, is a quantity, quality, restriction, or limit associated with the command or query header. Depending on the command or query header given, the argument is one of the following types:

- Decimal Numeric
- Nondecimal Numeric
- Logical Data
- String
- Arbitrary Block

**5Decimal Numeric.** The Arbitrary Function Generator defines a decimal numeric argument as one expressed in one of three numeric representations: NR1, NR2, or NR3. This definition complies with that found in ANSI/IEEE Std 488.2-1987. Any commands that use arguments in any of the the first three notations can use a fourth notation NRf (for Numerical Representation flexible). Refer to Table 4-2.

**Table 4-2: Decimal Numeric Notation**

| Type | Format  | Examples                 |
|------|---|--------------------------|
| NR1  | implicit point (integer)  | 1, +3, -2, +10, -20      |
| NR2  | explicit point unscaled (fixed point)                                 | 1, 2, +23.5, -0.15       |
| NR3  | explicit point scaled (floating point)                                | 1E+2, +3.36E-2, -1.02E+3 |
| NRf  | numeric representation flexible; any of NR1, NR2, and NR3 may be used | 1, +23.5, -1.02E+3       |

As just implied, you can use NRf notation for arguments in your programs for any commands that this manual lists as using any of NR1, NR2, or NR3 notation in its arguments. Be aware, however, that query response will still be in the format specified in the command. For example:

```
:STATus:OPERation:ENABLE <NR1>
```

If the command description is the above notation, you can substitute NR2 or NR3 when using the command in a program. However, if you use the query as:

```
:STATus:OPERation:ENABLE?
```

the Arbitrary Function Generator will respond in the format <NR1> to match the command description in this manual.

```
<NR1>
```

**Nondecimal Numeric.** Nondecimal numeric data is data that begins with #{H|h, Q|q, B|b}.

```
#Habiz
#Q377
#B01101100
```

**Logical Data.** Logical data is noted as Boolean and is noted as not 0 or 0, or as ON or OFF.

```
OUTPut:STATe ON
```

**String.** String, sometimes referred to as a string literal, a literal, or just a string, is defined as a series of characters enclosed by double quotation marks (") as in the following example:

```
"This is a string constant" or "0 .. 127"
```

To include a double quoted character in the string, insert an additional double quote character ahead of the double quote character in the string. For example, the string:

```
serial number "B010000"
```

would be defined as:

```
"serial number ""B010000"""
```

Single quotation marks (') can also be used instead of double quotation marks. For instance:

```
'serial number 'B010000''
```

**Arbitrary Block.** An arbitrary block argument is defined as:

```
#<byte count digit><byte count>[<contiguous eight-bit data byte>]...
```

or:

```
#0[<contiguous eight-bit data byte>]... <terminator>
```

where:

<byte count digit> ::= a nonzero digit in the range ASCII 1–9 that defines the number of digits (bytes) in the <byte count> field.

<byte count> ::= any number of digits in the range ASCII 0–9 that define how many bytes are in the <contiguous 8-bit data byte> field.

<contiguous 8-bit data byte> ::= a <byte count> number of 8-bit bytes in the range ASCII 0–255 that define the message. Each byte defines one character.

<terminator> ::= a software LF followed by a hardware EOI. For example,

```
#16AB4ZLT<LF><&EOI>  
#0EHTGNILEDOM<LF><&EOI>
```

**Unit and SI Prefix.** If the decimal numeric argument refers to a voltage, frequency, or percentage, you can express it using SI units instead of in the scaled explicit point input value format <NR3>. (SI units are units that conform to the System International d'Unites standard.)



For example, you can use 200mV instead of 200.0E-3 to specify voltage, or 1.0MHz instead of 11.0E+6 to specify frequency.

You can omit the unit, but you must include the SI unit prefix. You can use either upper or lowercase units as listed below:

V or v for voltage  
 Hz, HZ, or hz for frequency  
 PCT, PCt, Pct, or pct for % (percentage)  
 s, S, Sec, SEC or sec for time  
 Rad, RAD, or rad for radian  
 Deg, DEG, or deg for degree

The SI prefixes, which must be included, are shown below. Note that the prefixes are case insensitive, you can use either upper or lower case. However, the prefix m or M equals  $10^{-3}$  for voltage parameters, but m or M equals  $10^6$  for frequency parameters. The prefix k or K always equals  $10^3$ .

| SI Prefix <sup>1</sup> | m/M       | k/K    | m/M    |
|------------------------|-----------|--------|--------|
| Corresponding Power    | $10^{-3}$ | $10^3$ | $10^6$ |

<sup>1</sup> **Note that the prefix m/M indicates  $10^{-3}$  when the decimal numeric argument denotes voltage, but  $10^6$  when it denotes frequency.**

For example, the following values are equivalent:

- 1.60 mhz, 1.60 mHz, 1.60 MHZ
- 250 mv, 250 mV, 250 MV

## Concatenating Commands

Most of the compound command headers are in a tree structure. The tree structure of an example command is diagrammed below. Note that the top of the structure always begins with a colon (:).

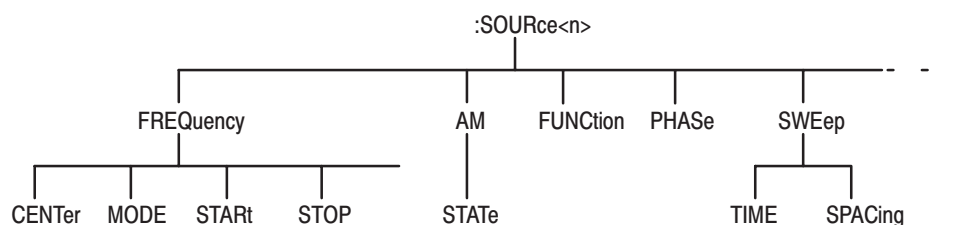

The following example of a compound command combines five headers delimited by semicolons:

```
:SOURce1:FREQuency:STARt 1E+6; :SOURce1:FREQuency:STOP 2E+6;  
:SOURce1:SWEep:SPACing LINear; :SOURce1:SWEep:TIME 1E-2;  
:SOURce1:FREQuency:MODE SWEep
```

You must include the complete path in each header when there is no common complete path to the start of the tree structure (the colon). However, note that part of each header in the above example has common path :SOURce1:FRE-Quency or :SOURce1:SWEep. You may shorten compound command structures with such headers. For example, the command above may be rewritten as follows.

```
:SOURce1:FREQuency:STARt 1E+6; STOP 2E+6;  
:SOURce1:SWEep:SPACing LINear; TIME 1E-2;  
:SOURce1:FREQuency:MODE SWEep
```

Note that the mnemonics :SOURce1, :FREQuency, and :SWEep are assumed from the first header by the headers that follow. The following command descriptions are valid examples of commands shortened using the principle just described. (Note that the insertion of common command (\*ESE) between headers does not prevent the headers that follow from assuming the earlier header mnemonics.)

```
:SOURce1:FREQuency:STARt 1E+6; *ESE 255; STOP 2E+6;  
:SOURce1:SWEep:SPACing LINear; TIME 1E-2;  
:SOURce1:FREQuency:MODE SWEep
```

The following examples have been shortened incorrectly and cause errors:

```
:SOURce1:FREQuency:STARt 1E+6; SOURce1:FREQuency:STOP 2E+6
```

A colon is omitted at the front of the second header SOURce1 in the above example.

```
:SOURce1:FREQuency:STARt 1E+6; :SOURce1:MODE SWEep
```

:FREQuency is omitted at the next to the second header SOURce1 in the above example.

The following examples have been described incorrectly and cause errors:

```
:SOURce1:FREQuency:STARt 1E+6; :*ESE 255;  
:SOURce1:FREQuency:MODE SWEep
```

A colon is added at the front of the common command header \*ESE in the above example.

## Other General Command Conventions

Following are some examples of other general command conventions.

**Upper and Lower Case.** The instrument accepts upper, lower, or mixed case alphabetic messages. The following three commands are recognized as identical:

```
MODE1:TYPE CONTINUOUS
mode1:type continuous
Mode1:Type Continuous
```

**Abbreviation.** Any header, argument, or reserved word that is sent to the Arbitrary Function Generator can be abbreviated. The minimum required spelling is shown in upper case throughout the *Command Groups* subsection beginning on page 4–16.

When a number is added at the end of the header mnemonic, a number “1” may be omitted but a number “2” may not be omitted. Consider the following example:

```
SOURce<n>:FUNCtion SINusoid
```

If *n* is designated for 1 in the above command, the command can be rewritten in the following forms.

```
SOURce:FUNCtion SINusoid
```

If *n* is designated for 2 in the above command, the command can be shortened in either of the following forms.

```
SOUR2:FUNC SINusoid
SOUR2:FUNC SIN
```

## Response Messages

Information on query responses and retrieving response messages is provided below.

**Query Responses.** The query causes the Arbitrary Function Generator to return information about its status or settings. When a query command is sent to the Arbitrary Function Generator, only the values are returned. When the value is a mnemonic, it is noted in abbreviated format. Refer to Table 4–3.

**Table 4–3: Query Responses**

| Query                     | Response |
|---------------------------|----------|
| SOURce:VOLTage:AMPLitude? | 1.000    |
| MODE1:TYPE?               | CONT     |

A few queries also initiate an operation action before returning information; for instance, the \*CAL? query runs a calibration.

**Retrieving Response Messages.** Figure 4–6 shows the response message retrieval operation when a GPIB interface is used. When a query command is sent from the external controller the Arbitrary Function Generator puts the response message for the query on the output queue. This response message cannot be retrieved unless the user performs a retrieval operation through the external controller.

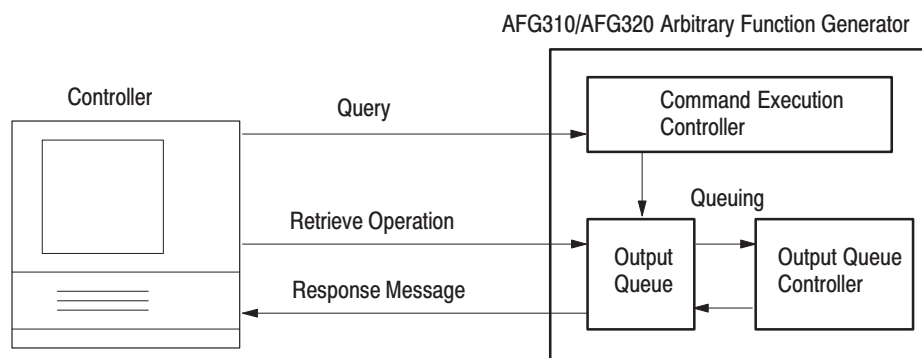

**Figure 4–6: GPIB: Retrieving Response Messages**

If there is a response message queued in the output queue and another query command is sent from the external controller before a retrieval operation for the earlier message is performed, the Arbitrary Function Generator will delete the queued response message and put the response message for the more recently sent query command in the output queue.

The SBR (status byte register) MAV bit can be used to check the response message queuing state. Refer to *Status and Events*, beginning on page 5–1, for more information on the output queue, SBR, and control methods.

## Waveform Transfer

The waveform transfer function transfers waveforms between the Arbitrary Function Generator and an external controller. This function can be used to transfer waveforms created by the external controller to the Arbitrary Function Generator.

These Arbitrary Function Generators are also equipped with import functions to transfer waveforms directly with Tektronix digital oscilloscopes and other AFG300 series instruments using a GPIB interface. Refer to *Tutorial 4* on page 2–48 and *Import From* on page 3–28 for details on the use of import function.

“Destination” refers to the destination for the waveform transfer when waveforms are transferred from the external controller to the Arbitrary Function

Generator. The transfer destination must be the Edit memory. The Edit memory will be overwritten when waveforms are transferred.

Waveform transfer is performed under the Tektronix Std. Codes and Formats waveform format specifications. The following part describes the waveform transfer method between these Arbitrary Function Generators and external controllers.

**Waveform Data Format.** Unscaled waveform data can be transferred from the external controller to the Arbitrary Function Generator by specifying an arbitrary block in the format shown below as the argument to the TRACe|DATA:[DATA] command.

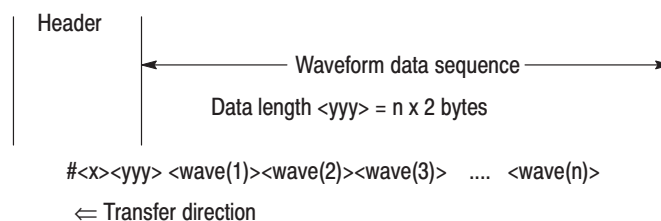

Here <yyy> is the byte count (in ASCII format) of the waveform data sequence that follows, <x> is the number of digits in <yyy> (in ASCII format), and <wave(i)> is the waveform datum.

Each data point <wave(i)> is transferred as an unsigned integer code of two bytes with 12 valid data bits. When data is transferred in the two byte width, the byte order (which of the upper and lower bytes is transferred first) can be specified using the FORMat:BORDER command.

Byte order specification allows data to be stored more easily in memory by specifying the appropriate order depending on whether the external controller CPU uses a Little-Endian or Big-Endian addressing scheme. For example, if an NEC PC-9800 series or an IBM-PC compatible is used as the external controller, set data to be transferred with the low order byte first.

**Data Transfer Procedures.** The following example shows the procedures for transferring waveforms from an external controller to the Arbitrary Function Generator.

1. Specify the data byte order for the waveform data points.

FORMat:BORDER NORMal

This command specifies transfer with the high order byte first. To transfer the low order byte first specify SWAPped instead of NORMal.

2. Transfer the waveform data.

TRACe|DATA[:DATA] EMEMory,<block>

This completes the transfer of a waveform block data from the external controller to the Edit memory in the Arbitrary Function Generator.

## Command Groups

This section describes the organization of the Arbitrary Function Generator command set into functional groups. (Refer to *Command Descriptions* on page 4–28 for a complete description of each command in alphabetical order.)

Included are commands that conform to SCPI (Standard Commands for Programmable Instruments) 1994.0 and IEEE 488.2 common commands. The commands that conform to SCPI and those that are not prescribed by SCPI are classified by function into nine different command subsystems.

Refer to *Command Syntax* on page 4–5 for a discussion of the notation used in this section.

### CALibration Subsystem Commands

The commands in this subsystem are used to calibrate the Arbitrary Function Generators. For error codes used to denote the result of calibration operations, refer to *Status and Events: Event Codes and Messages* on page 5–10. Remote commands and front panel operations are not possible while calibration is in progress.

CALibration

[:ALL]

[:ALL]?

**Table 4-4: CALibration Subsystem Commands**

| Header  | Description                                     |
|---------|---|
| [:ALL]  | Perform all calibrations                        |
| [:ALL]? | Perform all calibrations and return the results |

**FORMat Subsystem  
Commands**

The commands in this subsystem are used to set the format used for data transfers.

FORMat

:BORDER NORMal|SWAPped

:BORDER?

**Table 4-5: FORMat Subsystem Commands**

| Header   | Description   |
|----------|---|
| :BORDER  | Designates the byte order (which is first: NORMal => MSB or SWAPped => LSB) |
| :BORDER? | Returns the byte order that is currently set                                |

**INSTrument Subsystem  
Commands**

The commands in this subsystem are provided with a function for use on multiple channel instruments in which the designated menu item can be used to set both channels to the same value.

INSTrument

:COUPLE ALL|NONE

:COUPLE?

:AMPLitude ALL|NONE

:AMPLitude?

:FREQuency ALL|NONE

:FREQuency?

:OFFSet ALL|NONE

:OFFSet?

:PHASe ALL|NONE

:PHASe?

**Table 4-6: INSTRUMENT Subsystem Commands**

| Header             | Description   |
|--------------------|---|
| :COUPLe            | Sets the function to set the same values for amplitude, frequency, offset and phase for both channels |
| :COUPLe?           | Returns the status of the function currently set  |
| :COUPLe:AMPLitude  | Sets the function to set the same value for amplitude for both channels                               |
| :COUPLe:AMPLitude? | Returns the status of the function currently set  |
| :COUPLe:FREQuency  | Sets the function to set the same value for frequency for both channels                               |
| :COUPLe:FREQuency? | Returns the status of the function currently set  |
| :COUPLe:OFFSet     | Sets the function to set the same value for offset for both channels                                  |
| :COUPLe:OFFSet?    | Returns the status of the function currently set  |
| :COUPLe:PHASe      | Sets the function to set the same value for phase for both channels                                   |
| :COUPLe:PHASe?     | Returns the status of the function currently set  |

**MODE Subsystem Commands**

The commands in this subsystem are used to select the operating mode for waveform output and set the burst count. The header suffix <n> designates the channel to be set. You should set <n> to the number corresponding to the channel to be set.

MODE<n>

[[:TYPE] CONTInuous|TRIGgered|BURSt

[[:TYPE]?

:BCOunt <numeric\_value>|INFinity

:BCOunt? [MINimum|MAXimum]

**Table 4-7: MODE Subsystem Commands**

| Header    | Description                              |
|-----------|--|
| [[:TYPE]  | Selects the operating mode               |
| [[:TYPE]? | Returns the operating mode currently set |
| :BCOunt   | Sets the burst count                     |
| :BCOunt?  | Returns the burst count currently set    |



**OUTPut Subsystem  
Commands**

The commands in this subsystem are used to set ON or OFF status for the waveform output port. The header suffix <n> designates the channel to be set. You should set <n> to the number corresponding to the channel to be set.

OUTPut<n>

[:STATe] <Boolean>

[:STATe]?

**Table 4-8: OUTPut Subsystem Commands**

| Header    | Description   |
|-----------|---|
| [:STATe]  | Selects ON or OFF status for the waveform output port   |
| [:STATe]? | Returns (as logical data) the ON/OFF status of the waveform output port that is currently set |

**SOURce Subsystem  
Commands**

The commands in this subsystem are used to select the output waveform, set the parameters for waveform output, select the type of modulation, set the parameters for modulation, set the sweep parameters, and so on. The output waveform and parameters can be set for the channel designated by the header suffix <n>, which stands for the number corresponding to the channel to be set.

[SOURce<n>]

:AM

:STATe <Boolean>

:STATe?

:FM

[:DEVIation] <numeric\_value>

[:DEVIation]? [MINimum|MAXimum]

:INTernal

:FREQuency <numeric\_value>

:FREQuency? [MINimum|MAXimum]

:FUNCTion SINusoid|SQUare|TRIangle|RAMP|

```

USER[1]|USER2|USER3|USER4|EMEMory
    :FUNction?
    :STATe <Boolean>
    :STATe?
:FREQuency
    [:CW|:FIXed] <numeric_value>
    [:CW|:FIXed]? [MINimum|MAXimum]
    :MODE CW|FIXed|SWEEP
    MODE?
    :STARt <numeric_value>
    :STARt? [MINimum|MAXimum]
    :STOP <numeric_value>
    :STOP? [MINimum|MAXimum]
:FSKey
    [:FREQuency] <numeric_value>
    [:FREQuency]? [MINimum|MAXimum]
    :INTernal
        :RATE <numeric_value>
        :RATE? [MINimum|MAXimum]
    :STATe <Boolean>
    :STATe?
:FUNction
    [:SHAPe] SINusoid|SQUare|TRIangle|RAMP|PULSe|
PRNoise|DC|USER[1]|USER2|USER3|
USER4|EMEMory
    [:SHAPe]?
    :PHASe
        [:ADJust] <numeric_value>

```

[[:ADJ]ust]? [MINimum|MAXimum]

#### PULSe

:DCYcle <numeric\_value>

:DCYcle? [MINimum|MAXimum]

#### SWEep

:TIME <numeric\_value>

:TIME? [MINimum|MAXimum]

:SPACing LINear|LOGarithmic

:SPACing?

#### VOLTage

[[:LE]Vel]

[[:IM]Mediate]

[[:AMPL]itude] <numeric\_value>

[[:AMPL]itude]? [MINimum|MAXimum]

:OFFSet <numeric\_value>

:OFFSet? [MINimum|MAXimum]

**Table 4-9: SOURCE Subsystem Commands**

| Header                  | Description  |
|-------------------------|--|
| :AM:STATe               | Sets ON or OFF status for AM modulation  |
| :AM:STATe?              | Returns (as logical data) the ON/OFF status of the AM modulation that is currently set   |
| :FM[:DE]Viation]        | Sets peak frequency deviation for FM modulation  |
| :FM[:DE]Viation)?       | Returns peak frequency deviation for FM modulation that is currently set                 |
| :FM:INTernal:FREQuency  | Sets the frequency of the modulating waveform for FM modulation                          |
| :FM:INTernal:FREQuency? | Returns the frequency of the modulating waveform for FM modulation that is currently set |
| :FM:INTernal:FUNcTion   | Selects the shape of the modulating waveform for FM modulation                           |
| :FM:INTernal:FUNcTion?  | Returns the shape of the modulating waveform for FM modulation that is currently set     |

**Table 4–9: SOURCE Subsystem Commands (Cont.)**

| Header                                       | Description   |
|--|---|
| :FM:STATe                                    | Sets ON or OFF status for FM modulation   |
| :FM:STATe?                                   | Returns (as logical data) the ON/OFF status of the FM modulation that is currently set      |
| :FREQUency[:CW :FIXed]                       | Sets output signal frequency  |
| :FREQUency[:CW :FIXed]?                      | Returns output signal frequency that is currently set                                       |
| :FREQUency:MODE                              | Selects frequency mode to be fixed or sweep   |
| :FREQUency:MODE?                             | Returns the frequency mode that is currently set  |
| :FREQUency:STARt                             | Sets the start frequency for sweep  |
| :FREQUency:STARt?                            | Returns the start frequency that is currently set   |
| :FREQUency:STOP                              | Sets the stop frequency for sweep   |
| :FREQUency:STOP?                             | Returns the stop frequency that is currently set  |
| :FSKey[:FREQUency]                           | Sets the FSK “hop” frequency for FSK modulation   |
| :FSKey[:FREQUency]?                          | Returns the FSK “hop” frequency that is currently set                                       |
| :FSKey:INTernal:RATE                         | Sets the rate at which the output frequency shifts between the carrier and hop frequency    |
| :FSKey:INTernal:RATE?                        | Returns the FSK rate that is currently set  |
| :FSKey:STATe                                 | Sets ON or OFF status for FSKey modulation  |
| :FSKey:STATe?                                | Returns (as logical data) the ON/OFF status of the FSKey modulation that is currently set   |
| :FUNCTion[:SHAPe]                            | Selects the output waveform   |
| :FUNCTion[:SHAPe]?                           | Returns the output waveform that is currently set   |
| :PHASe[:ADJust]                              | Sets the phase of the output waveform   |
| :PHASe[:ADJust]?                             | Returns the phase of the output waveform that is currently set                              |
| :PULSe:DCYClE                                | Sets the duty ratio of the pulse wave   |
| :PULSe:DCYClE?                               | Returns the duty ratio of the pulse wave that is currently set                              |
| :SWEep:TIME                                  | Sets the number of seconds required to sweep from the start frequency to the stop frequency |
| :SWEep:TIME?                                 | Returns the sweep time that is currently set  |
| :SWEep:SPACing                               | Selects linear or logarithmic spacing for the sweep   |
| :SWEep:SPACing?                              | Returns the sweep spacing that is currently set   |
| :VOLTage[:LEVel]<br>[:IMMediate][:AMPLitude] | Sets the output amplitude for the currently active waveform                                 |

**Table 4-9: SOURce Subsystem Commands (Cont.)**

| Header                                    | Description  |
|---|--|
| :VOLTage[:LEVel][:IMMediate][:AMPLitude]? | Returns the output amplitude that is currently set           |
| :VOLTage[:LEVel][:IMMediate][:OFFSet]     | Sets the DC offset voltage for the currently active waveform |
| :VOLTage[:LEVel][:IMMediate][:OFFSet]?    | Returns the DC offset voltage that is currently set          |

**STATus Subsystem Commands**

The commands in this subsystem are used to control status and error/events. For information on the instrument's status reporting function, see *Error/Event Reporting* on page 5–10.

## STATus

```

:OPERation
    :CONDition?
    :ENABle <NRf>
    :ENABle?
    [:EVENT]?
:PRESet
:QUEStionable
    :CONDition?
    :ENABle <NRf>
    :ENABle?
    [:EVENT]?
:QUEue
    [:NEXT]?
```

**Table 4-10: STATus Subsystem Commands**

| Header                | Description   |
|-----------------------|---|
| :OPERation:CONDition? | Returns the contents of the operation status condition register |
| :OPERation:ENABle     | Sets the operation status enable mask                           |

**Table 4-10: STATus Subsystem Commands (Cont.)**

| Header                   | Description  |
|--------------------------|--|
| :OPERation:ENABle?       | Returns the value for enable mask that is currently set                |
| :OPERation[:EVENT]?      | Returns the contents of the operation status event register            |
| :PRESet                  | Presets the status register on SCPI                                    |
| :QUEStionable:CONDition? | Returns the contents of the operation status condition register        |
| :QUEStionable:ENABle     | Sets the questionable status enable mask                               |
| :QUEStionable:ENABle?    | Returns the value for enable mask that is currently set                |
| :QUEStionable[:EVENT]?   | Returns the contents of the questionable status event register         |
| :QUEue[:NEXT]?           | Retrieves error data from the error/event queue and returns this data. |

### SYSTem Subsystem Command

The commands in this subsystem are used to set the beep, lock the front panel controls, set default values, set step recall mode, and ask for the SCPI versions of the commands used on the instrument, as well as to retrieve error numbers from the error/event queue used by the status reporting function. For information on the error/event queue, refer to *Queue* on page 5-9.

#### SYSTem

```

:BEEPer
    :STATe <Boolean>
    :STATe?

ERRor?

KLOCK <Boolean>
KLOCK?

:SECurity
    :IMMediate

:SRECall
    [:STATe] <Boolean>
    [:STATe]?

```

```

:ULIMit <numeric_value>
:ULIMit? [MINimum]MAXimum]
VERSion?

```

**Table 4-11: SYSTem Subsystem Commands**

| Header              | Description   |
|---------------------|---|
| :BEEPer:STATe       | Sets ON or OFF status for beep sound  |
| :BEEPer:STATe?      | Returns (as logical data) the ON/OFF status of the beep sound that is currently set         |
| :ERRor?             | Retrieves error data from the error/event queue and returns this data.                      |
| :KLOCK              | Locks or unlocks the controls on the front panel  |
| :KLOCK?             | Returns the current setting status for the controls on the front panel                      |
| :SECurity:IMMediate | Returns all settings to instrument factory default values include initializing NVRam memory |
| :SRECall[:STATe]    | Sets ON or OFF status for step-recall mode  |
| :SRECall[:STATe]?   | Returns (as logical data) the ON/OFF status of the step-recall mode that is currently set   |
| :ULIMit             | Sets the upper limit for the setup memory number during step-recall mode on                 |
| :ULIMit?            | Returns the upper limit for the setup memory number that is currently set                   |
| :VERSion?           | Returns the SCPI version  |

### TRACe|DATA Subsystem Commands

The commands in this subsystem are used to set the contents of the edit memory and user waveform memory.

TRACe|DATA

```

:CATalog?
:COPIY <trace_name>,EMEMory
[:DATA] EMEMory,<block>
:LINE EMEMory,<numeric_value>,<numeric_value>,
<numeric_value>,<numeric_value>
:VALue EMEMory,<numeric_value>,<numeric_value>
:VALue? EMEMory,<numeric_value>

```

```

:DEFine EMEMory[,{<numeric_value>|<trace_name>}]
:LOCK
  [:STATe] <trace_name>,<boolean>
  [:STATe]? <trace_name>
:POINts EMEMory[,<numeric_value>]
:POINts? EMEMory
    
```

**Table 4-12: TRACe|DATA Subsystem Commands**

| Header         | Description   |
|----------------|---|
| :CATalog?      | Returns the name of the waveform in the user waveform memory and edit memory            |
| :COPY          | Copies the contents of the edit memory to the user waveform memory                      |
| [:DATA]        | Writes binary integer from 0 to 4094 to the edit memory                                 |
| [:DATA]:LINE   | Writes line data to the range designated by two point numbers in the edit memory        |
| [:DATA]:VALue  | Writes point data to the designated point number in the edit memory                     |
| [:DATA]:VALue? | Returns point data at the designated point number                                       |
| :DEFine        | Defines the edit memory in terms of the contents of the designated user waveform memory |
| :LOCK[:STATe]  | Prohibits/enables writing to the user waveform memory                                   |
| :LOCK[:STATe]? | Returns the current setting status for the writings                                     |
| :POINts        | Sets the number of waveform points in the edit memory                                   |
| :POINts?       | Returns the number of waveform points in the edit memory that is currently set          |



## IEEE-488.2 Common Commands

The IEEE-488.2 standard defines a set of common commands that perform functions like rest, calibration, and status operations. The common commands always begin with an asterisk.

**Table 4-13: IEEE-488.2 Common Commands**

| Header | Description  |
|--------|--|
| *CAL?  | Performs all calibrations and returns the results  |
| *CLS   | Clears SESR, SBR and Error/Event Queue   |
| *ESE   | Sets a value in the ESER   |
| *ESE?  | Returns the value in the ESER that is currently set  |
| *ESR?  | Returns the value in the SESR  |
| *IDN?  | Returns ID information about the Arbitrary Function Generator  |
| *OPC   | Checks to see if command execution has ended and, if it has, sets the OPC bit in the SESR                |
| *OPC?  | Checks to see if command execution has ended and, if it has, returns 1                                   |
| *OPT?  | Returns information which options are implemented for this Arbitrary Function Generator                  |
| *RCL   | Recalls settings in the memory   |
| *RST   | Performs system reset  |
| *SAV   | Saves current settings in the memory   |
| *SRE   | Sets a value in the SRER   |
| *SRE?  | Returns the value in the SRER that is currently set  |
| *STB?  | Returns the value in the SBR   |
| *TRG   | Generates the triggering event   |
| *TST?  | Performs all self test and return the results  |
| *WAI   | Causes the instrument to wait, delaying the start of the next process until the end of command execution |

## Command Descriptions

This section lists each command and query in the Arbitrary Function Generator command set alphabetically.

Each command entry includes its command description and group, its syntax, and its arguments (if any), and its responses (if any). Each entry also includes one or more usage examples.

This section fully spells out headers, mnemonics, and arguments with the minimal spelling shown in upper case. For example, to use the abbreviated version of the SOURce1:SWEep:SPACing command, just type SOUR1:SWE:SPAC.

For more information on the following commands, refer to *Status and Events* beginning on page 5–1.

### **\*CAL? (Query Only)**

The \*CAL? common query performs an internal calibration and returns status that indicates whether the Arbitrary Function Generator completes the self calibration without error. This query has the same function as the CALibration[:ALL]? query.

If errors are detected during calibration, the error code for the first error to be discovered is returned.

---

**NOTE.** *Up to 3 minutes are required to complete the internal calibration for the AFG320. and 1 1/2 minutes for AFG310. During this time, the Arbitrary Function Generator does not respond to any commands or queries issued.*

---

#### **Group.**

IEEE–488.2 Common Command.

#### **Syntax.**

\*CAL?

#### **Responses.**

<Result>

where <Result>::=<NR1>, which is one of following decimal integers:

|     |                                  |
|-----|----------------------------------|
| 0   | terminated without error.        |
| 600 | Calibration error                |
| 601 | Offset calibration error         |
| 602 | Arbitrary gain calibration error |
| 603 | Sine gain calibration error      |

|     |                                     |
|-----|-------------------------------------|
| 604 | Square gain calibration error       |
| 605 | AM offset calibration error         |
| 606 | Sine flatness calibration error     |
| 607 | Output attenuator calibration error |

**Examples.**

\*CAL?

performs an internal calibration and returns the results (for example, it might return 0, which indicates the calibration terminated without any detected errors).

**CALibration[:ALL]**

The CALibration[:ALL] command performs an internal calibration.

The CALibration[:ALL]? query performs an internal calibration and returns status that indicates whether the Arbitrary Function Generator completes the self calibration without error. This query has the same function as the \*CAL? query.

If an error is detected while calibration is being executed, a message is queued in the error/event queue, and the error code of the first error discovered is returned in response to the query.

Analog output operations are performed on this unit using a calibrated value stored inside the unit. If this command is used to execute calibration, the new calibrated value is used.

If errors are detected during calibration, the error code for the first error to be discovered is returned.

**Group.**

CALibration subsystem Command (SCPI).

**Syntax.**

CALibration[:ALL]

CALibration[:ALL]?

**Responses.**

<Result>

where <Result>::=<NR1>, which is one of the following decimal integers:

|     |                                  |
|-----|----------------------------------|
| 0   | Terminated without error.        |
| 600 | Calibration error                |
| 601 | Offset calibration error         |
| 602 | Arbitrary gain calibration error |
| 603 | Sine gain calibration error      |
| 604 | Square gain calibration error    |
| 605 | AM offset calibration error      |

606 Sine flatness calibration error  
607 Output attenuator calibration error

**Examples.**

CALibration[:ALL]  
performs an internal calibration.

CALibration[:ALL]?  
performs an internal calibration and returns the results (for example, it might return 0, which indicates the calibration terminated without any detected errors).

**\*CLS  
(Command Only)**

The \*CLS common command clears all the event registers and queues, which are used in the Arbitrary Function Generator status and event reporting system.

**Group.**

IEEE-488.2 Common Command.

**Syntax.**

\*CLS

**Examples.**

\*CLS  
clears all the event registers and queues.

**\*ESE**

The \*ESE common command sets the bits of the ESER (Event Status Enable Register) used in the status and events reporting system of the Arbitrary Function Generator.

The \*ESE? query returns the contents of the ESER.

**Group.**

IEEE-488.2 Common Command.

**Syntax.**

\*ESE <Bit Value>  
\*ESE?

**Arguments.**

<Bit Value>::=<NR1>

where <NR1> is a decimal integer that ranges from 0 to 255. The ESER bits will be set to the binary equivalent of the decimal integer sent.

The power-on default for the ESER is to reset all bits to zero.

**Examples.**

\*ESE 177

sets the ESER to 177 (binary 10110001), which sets the PON, CME, EXE and OPC bits.

\*ESE?

might return 176, which indicates that the ESER contains the binary number 11010000.

**\*ESR?  
(Query Only)**

The \*ESR? common query returns the contents of SESR (Standard Event Status Register) used in the status and events reporting system.

**Group.**

IEEE-488.2 Common Command.

**Syntax.**

\*ESR?

**Responses.**

<ESR-bits>

<ESR-bits>::<NR1>

where <NR1> is a decimal integer that ranges from 0 to 255. The decimal integer is equivalent to the binary data in the ESER.

**Examples.**

\*ESR?

might return 181, which indicates that the SESR contains the binary number 10110101.

**FORMat:BORDER**

The FORMat:BORDER command specifies whether the MSB (most significant byte) or LSB (least significant byte) is sent first for each waveform point during binary block data transfers.

The FORMat:BORDER? query returns the transfer sequence for binary block data.

Data for waveform points is expressed as 12-bit integers. To transfer this data through an 8-bit interface, the data for each waveform point must be transferred as 2-byte data.

**Group.**

FORMat subsystem Command (SCPI).

**Syntax.**

FORMat:BORDER {NORMal|SWAPped}  
FORMat:BORDER?

**Arguments.**

NORMal

sends the upper byte (MSB) of the binary data first, then the lower byte for each waveform point.

SWAPped

sends the lower byte (LSB) of the binary data first, then the upper byte for each waveform point.

The argument is set to NORMal when the Arbitrary Function Generator is powered on or the \*RST command is sent to this instrument.

**Examples.**

FORMat:BORDER NORMal

specifies that MSB will be sent first in binary block data transfers.

FORMat:BORDER?

might return NORMal, which indicates that MSB first is set for the transfer sequence.

**\*IND?  
(Query Only)**

The \*IDN? common query returns the ID information of the Arbitrary Function Generator.

**Group.**

IEEE-488.2 Common Command.

**Syntax.**

\*IDN?

**Responses.**

<Manufacturer>, <Model>, <Serial Number>, <Firmware Level>

where

<Manufacturer>::=SONY/TEK,

<Model>::=AFG310 | AFG320

<Serial Number>::=0, (0 indicates no application.)

<Firmware Level>::=SCPI:<SCPI Version>,

<sp>FW:<Firmware Version>, and

<sp>::= Space.

**Examples.**

\*IDN?

might return SONY/TEK,AFG320,0,SCPI:94.0 FW:1.0

**INSTrument:COUPle  
(AFG320 Only)**

The INSTrument:COUPle command specifies whether the same values for amplitude, frequency, offset and phase will be set for both Channel 1 and Channel 2 or if these values will be set independently for each channel.

The INSTrument:COUPle? query returns the designated setting.

**Group.**

INSTrument subsystem Command (SCPI).

**Syntax.**

INSTrument:COUPle {ALL|NONE}

INSTrument:COUPle?

**Arguments.**

ALL

specifies the Both Input Mode, which sets the same values for amplitude, frequency, offset and phase for Channel 1 and Channel 2. A channel 1 may be delayed about 30 ms by the inside process forward the Channel 2.

NONE

specifies the mode in which values for the five parameters will be set independently for Channel 1 and Channel 2.

The argument is reset to NONE when the Arbitrary Function Generator is powered on or the \*RST command is sent to this instrument.

**Examples.**

INSTrument:COUPle ALL

specifies the Both Input Mode and that the same values for amplitude, frequency, offset and phase will be set for both Channel 1 and Channel 2.

INSTrument:COUPle?

might return ALL, which indicates that same values for the five parameters will be set for both Channel 1 and Channel 2.

**INSTrument:  
COUPle:AMPLitude  
(AFG320 Only)**

The INSTrument:COUPle:AMPLitude command specifies whether the same amplitude value will be set for both Channel 1 and Channel 2 or that amplitude values will be set independently for each channel.

The INSTrument:COUPle:AMPLitude? query returns the designated setting.

**Group.**

INSTrument subsystem Command (SCPI).

**Syntax.**

INSTrument:COUPle:AMPLitude {ALL|NONE}

INSTrument:COUPle:AMPLitude?

**Arguments.**

ALL

specifies the Both Input Mode which sets the same amplitude values for Channel 1 and Channel 2. A channel 1 may be delayed about 30 ms by the inside process forward the Channel 2.

NONE

specifies the mode in which amplitude values will be set independently for Channel 1 and Channel 2.

The argument is reset to NONE when the Arbitrary Function Generator is powered on or the \*RST command is sent to this instrument.

**Examples.**

INSTrument:COUPle:AMPLitude ALL

specifies the Both Input Mode which sets the same amplitude values for Channel 1 and Channel 2.

INSTrument:COUPle:AMPLitude?

might return ALL, which indicates that the same amplitude value will be set for both Channel 1 and Channel 2.

**INSTrument:  
COUPle:FREQuency  
(AFG320 Only)**

The INSTrument:COUPle:FREQuency command specifies whether the same frequency value will be set for both Channel 1 and Channel 2 or frequency values will be set independently for each channel.

The INSTrument:COUPle:AMPLitude? query returns the designated setting.

**Group.**

INSTrument subsystem Command (SCPI).

**Syntax.**

INSTrument:COUPle:FREQuency {ALL|NONE}

INSTrument:COUPle:FREQuency?



**Arguments.**

ALL

specifies the Both Input Mode and that the same frequency value will be set for both Channel 1 and Channel 2. A channel 1 may be delayed about 30 ms by the inside process forward the Channel 2.

NONE

specifies the mode in which frequency values will be set independently for Channel 1 and Channel 2.

The argument is reset to NONE when the Arbitrary Function Generator is powered on or the \*RST command is sent to this instrument.

**Examples.**

INSTrument:COUPle:FREQUency ALL

specifies the Both Input Mode and that the same frequency value will be set for both Channel 1 and Channel 2.

INSTrument:COUPle:FREQUency?

might return ALL, which indicates that the same frequency value will be set for both Channel 1 and Channel 2.

**INSTrument:  
COUPle:OFFSet  
(AFG320 Only)**

The INSTrument:COUPle:OFFSet command specifies whether the same offset value will be set for both Channel 1 and Channel 2 or offset values will be set independently for each channel.

The INSTrument:COUPle:OFFSet? query returns the designated setting.

**Group.**

INSTrument subsystem Command (SCPI).

**Syntax.**

INSTrument:COUPle:OFFSet { ALL|NONE }

INSTrument:COUPle:OFFSet?

**Arguments.**

ALL

specifies the Both Input Mode and that the same offset value will be set for both Channel 1 and Channel 2. A channel 1 may be delayed about 30 ms by the inside process forward the Channel 2.

NONE

specifies the mode in which offset values will be set independently for Channel 1 and Channel 2.

The argument is reset to NONE when the Arbitrary Function Generator is powered on or the \*RST command is sent to this instrument.

**Examples.**

INSTRument:COUPle:OFFSet ALL

specifies the Both Input Mode and that the same offset value will be set for both Channel 1 and Channel 2.

INSTRument:COUPle:OFFSet?

might return ALL, which indicates that the same offset value will be set for both Channel 1 and Channel 2.

**INSTRument:  
COUPle:PHASe  
(AFG320 Only)**

The INSTRument:COUPle:PHASe command specifies whether the same phase value will be set for both Channel 1 and Channel 2 or whether the phase values will be set independently for each channel.

The INSTRument:COUPle:OFFSet? query returns the designated setting.

**Group.**

INSTRument subsystem Command (SCPI).

**Syntax.**

INSTRument:COUPle:PHASe {ALL|NONE}

INSTRument:COUPle:PHASe?

**Arguments.**

ALL

specifies the Both Input Mode and that the same phase value will be set for both Channel 1 and Channel 2. A channel 1 may be delayed about 30 ms by the inside process forward the Channel 2.

NONE

specifies the mode in which phase values will be set independently for Channel 1 and Channel 2.

The argument is reset to NONE when the Arbitrary Function Generator is powered on or the \*RST command is sent to this instrument.

**Examples.**

INSTRument:COUPle:PHASe ALL

specifies the Both Input Mode and that the same phase value will be set for both Channel 1 and Channel 2.

INSTrument:COUPlE:PHASe?

might return ALL, which indicates that the same phase value will be set for both Channel 1 and Channel 2.

### **MODE<n>[:TYPE]**

The MODE<n>[:TYPE] command determines the operating mode when a trigger event occurs and a waveform is output to the channel designated by the header.

The MODE<n>[:TYPE]? query returns the operating mode that is currently set.

#### **Group.**

MODE subsystem Command (NonSCPI).

#### **Syntax.**

MODE<n>[:TYPE] {CONTInuous|TRIGgered|BURSt}

MODE<n>[:TYPE]?

#### **Arguments.**

CONTInuous

sets the continuous mode which continuously outputs the waveform. The Arbitrary Function Generator ignores the external trigger signals.

The external trigger signals are generated by a trigger signal input to the EXT TRIG IN connector, the MANUAL key on the front panel, or a remote command.

TRIGgered

The waveform is output for 1 cycle by an external trigger signal.

BURSt

sets the burst mode which outputs waveform for the number of cycles set by BCOunt (burst count) by an external trigger signal. If BCOunt is set to infinity (INFinity), the instrument ignores the burst count. The waveform will be output continuously when an external trigger signal is received.

The argument is reset to CONTInuous when the Arbitrary Function Generator is powered on or the \*RST command is sent to this instrument.

#### **Examples.**

MODE2:TYPE TRIGgered

sets the channel 2 output for triggered mode.

MODE2:TYPE?

might return TRIG, which indicates that the operating mode is set to triggered.

**MODE<n>:BCOunt**

The MODE<n>:BCOunt command determines the number of cycles (the burst count) for which the waveform is output in burst mode to the channel designated by the header suffix.

The MODE<n>:BCOunt? query returns the burst count currently set.

This command can be used to set or ask for a value regardless of the currently selected operating mode. Burst mode is set with the MODE<n>[:TYPE] BURSt command.

**Group.**

MODE subsystem Command (nonSCPI).

**Syntax.**

MODE<n>BCOunt {<count>|INFinity}

MODE<n>BCOunt?

**Arguments.**

<count>::=<NR1>

where the burst count ranges from 0 to 60 000.

<count>::=9.9E37

sets the burst count for infinity.

<INFinity

sets the burst count for infinity.

The argument is reset to 10 when the Arbitrary Function Generator is powered on or the \*RST command is sent to this instrument.

**Examples.**

MODE2:BCOunt 200

sets output for burst mode with 200 waveforms cycles.

MODE2:BCOunt?

might return 9.9000E+37, which indicates that the burst count is set to infinite.

**\*OPC**

The \*OPC common command generates an operation complete message by setting bit 0 in the Standard Event Status Register (SESR) when all pending operations are finished.

The \*OPC? common query enters a “1” in the Output Queue when all pending operations are finished.

**Group.**

IEEE-488.2 Common Command.

**Syntax.**

\*OPC  
\*OPC?

**Responses.**

<execution complete>::=1

where “1” indicates that all pending operations are finished (operation complete message).

**Examples.**

CALibration;\*OPC

might wait for the completion of calibration.

**\*OPT?  
(Query Only)**

The \*OPT? common query returns the implemented options of the Arbitrary Function Generator.

**Group.**

IEEE-488.2 Common Command.

**Syntax.**

\*OPT?

**Responses.**

<Option>[,<Option>]...

<Option>::=<NR1>

where <NR1> is a decimal integer as follows;

0                    indicates no option.

**Examples.**

\*OPT?

might return 0 to indicate that no option is installed in this instrument.

**OUTPut<n>[:STATE]**

The OUTPut<n>[:STATE] command sets the output port (turns the CH1 or CH2 waveform output on or off) for the channel designated by the header.

The OUTPut<n>[:STATE]? query returns the output port setting for the channel designated by the header.

**Group.**

OUTPut subsystem Command (SCPI).

**Syntax.**

OUTPut<n>[:STATe] {ON|OFF|<NR1>}  
OUTPut<n>[:STATe]?

**Arguments.**

ON or any nonzero value for <NR1>  
sets the output port to ON.

OFF or a 0 value for <NR1>  
sets the output port to OFF.

The output port is set to on or off by opening or closing the relays connected between the internal circuit and the output connector on the front panel.

The argument is reset to “0” when the Arbitrary Function Generator is powered on or the \*RST command is sent to this instrument.

**Responses.**

<Response>

<Response>::=<NR1>

where <NR1> is a decimal integer as follows;

- |   |  |
|---|--|
| 0 | the output port is currently turned off. |
| 1 | the output port is currently powered on. |

**Examples.**

OUTPut1:STATe ON  
turn on the channel 1 output port.

OUTPut1:STATE?  
returns the on/off status for the CH1 output port.

**\*RCL  
(Command Only)**

The \*RCL common command recalls the setting designated by the memory number in the settings memory. In such cases, the Arbitrary Function Generator will be set up in accordance with this setting value.

**Group.**

IEEE–488.2 Common Command.

**Syntax.**

\*RCL <Setup Memory Number>

**Arguments.**

<Setup Memory Number>::=<NR1>

where <NR1> is a memory number that ranges from 1 to 19.

**Examples.**

\*RCL 12

recalls the setup from the number 12 setting memory and set up the instrument with the setting values.

**\*RST  
(Command Only)**

The \*RST common command resets this Arbitrary Function Generator to the factory default state (default values are listed in *Secure Settings (Factory Settings)* on page E-4).

**Group.**

IEEE-488.2 Common Command.

**Syntax.**

\*RST

**Examples.**

\*RST

reset the instrument to its factory default settings.

**\*SAV  
(Command Only)**

The \*SAV common command saves the current settings of the Arbitrary Function Generator to the setting memory designated with memory number.

**Group.**

IEEE-488.2 Common Command.

**Syntax.**

\*SAV <Setup Memory Number>

**Arguments.**

<Setup Memory Number>::=<NR1>

where <NR1> is a memory number that ranges from 1 to 19.

**Examples.**

\*SAV 12

saves the current settings to the setting memory number 12.

**[SOURCE<n>]:AM:STATE**

The [SOURCE<n>]:AM:STATE command turns AM modulation on or off for the channel designated by the header suffix.

The [SOURCE<n>]:AM:STATE? query returns ON or OFF status for AM modulation for the channel designated by the header suffix.

When one of the other modulation functions (sweep, FM modulation or FSK modulation) is on, turning on AM modulation will automatically turn off the other modulation function.

On a single-channel instrument, SOURCE1 or SOURCE header can be valid for designating the channel. If channel 2 is designated on the dual-channel instrument, the SOURCE2 header cannot be omitted.

**Group.**

SOURCE subsystem Command (SCPI).

**Syntax.**

[SOURCE<n>]:AM:STATE {ON|OFF|<NR1>}  
 [SOURCE<n>]:AM:STATE?

**Arguments.**

ON or any nonzero value for <NR1>  
 sets AM modulation to ON.

OFF or 0 value for <NR1>  
 sets AM modulation to OFF.

The argument is reset to “0” when the Arbitrary Function Generator is powered on or the \*RST command is sent to this instrument.

**Responses.**

<Response>

<Response>::=<NR1>

where <NR1> is a decimal integer as follows;

- 0                    AM modulation is currently turned off.
- 1                    AM modulation is currently powered on.

**Examples.**

SOURCE1:AM:STATE ON  
 turn on CH1 AM modulation.

SOURCE1:AM:STATE?  
 might return 1, which indicate CH1 AM modulation is powered on.



**[SOURce<n>]:  
FM[:DEViation]**

The [SOURce<n>]:FM[:DEViation] command sets the peak frequency deviation of FM modulation for the channel designated by the header suffix.

The [SOURce<n>]:FM[:DEViation]? query returns the peak frequency deviation for the channel designated by the header suffix.

On a single-channel instrument, SOURce1 or SOURce header can be valid for designating the channel. If channel 2 is designated on the dual-channel instrument, the SOURce2 header cannot be omitted.

**Group.**

SOURce subsystem Command (SCPI).

**Syntax.**

```
[SOURce<n>]:FM[:DEViation] <Deviation>
[SOURce<n>]:FM[:DEViation]? [MINimum|MAXimum]
```

**Arguments.**

<Deviation>::=<NR3>[<unit>]

where

<NR3>           The peak frequency deviation ranges from 10 mHz to 8 MHz.

<unit>::=[Hz|kHz|MHz]

The argument is reset to 1.000 00 kHz when the Arbitrary Function Generator is powered on or the \*RST command is sent to this instrument.

**Responses.**

<Deviation>

<Deviation>::=<NR3>

The response to a query is as follows depending on the argument status:

<Argument>::=<None>     Returns the current setting

<Argument>::=<MINimum>   Returns the value to the available minimum setting

<Argument>::=<MAXimum>   Returns the value to the available maximum setting

**Examples.**

SOURce1:FREQuency:CENTer 5MHz;FM:DEViation 1MHz  
sets the center frequency of the carrier wave to 5 MHz and the frequency deviation to 1 MHz for the CH1 FM modulation.

**[SOURce<n>]:  
FM:INTernal:FREQuency**

The [SOURce<n>]:FM:INTernal:FREQuency command sets the modulating frequency of FM modulation for the channel designated by the header suffix.

The [SOURce<n>]:FM:INTernal:FREQuency? query returns the FM modulating frequency for the channel designated by the header suffix.

On a single-channel instrument, SOURce1 or SOURce header can be valid for designating the channel. If channel 2 is designated on the dual-channel instrument, the SOURce2 header cannot be omitted.

**Group.**

SOURce subsystem Command (SCPI).

**Syntax.**

[SOURce<n>]:FM:INTernal:FREQuency <Modulating Frequency>  
[SOURce<n>]:FM:INTernal:FREQuency? [MINimum|MAXimum]

**Arguments.**

<Modulating Frequency>::=<NR3>[<unit>]

where

<NR3>           The modulating frequency ranges from 10 mHz to 10 kHz.

<unit>::=[Hz|kHz]

The argument is reset to 1.000 kHz when the Arbitrary Function Generator is powered on or the \*RST command is sent to this instrument.

**Responses.**

<Modulating Frequency>

<Modulating Frequency>::=<NR3>

The response to a query is as follows depending on the argument status:

<Argument>::=<None>     Returns the current setting

<Argument>::=<MINimum>   Returns the value to the available minimum setting

<Argument>::=<MAXimum>   Returns the value to the available maximum setting

**Examples.**

SOURce1:FM:INTernal:FREQuency 5kHz

sets the modulating frequency to 5 kHz for the CH1 FM modulation.

**[SOURCE<n>]:  
FM:INTERNAL:FUNCTION**

The [SOURCE<n>]:FM:INTERNAL:FUNCTION command sets the shape of the modulating waveform of FM modulation for the channel designated by the header suffix.

The [SOURCE<n>]:FM:INTERNAL:FUNCTION? query returns the shape of the FM modulating waveform for the channel designated by the header suffix.

On a single-channel instrument, SOURCE1 or SOURCE header can be valid for designating the channel. If channel 2 is designated on the dual-channel instrument, the SOURCE2 header cannot be omitted.

**Group.**

SOURCE subsystem Command (SCPI).

**Syntax.**

```
[SOURCE<n>]:FM:INTERNAL:FUNCTION {SINusoid|SQUare|TRIangle|RAMP|
                                     USER[1]|USER2|USER3|USER4|EMEMory}
[SOURCE<n>]:FM:INTERNAL:FUNCTION?
```

**Arguments.**

SINusoid|SQUare|TRIangle|RAMP

One of four types of function wave is used as a modulating signal.

USER[1]|USER2|USER3|USER4

User wave saved in the user waveform memory is used as a modulating signal.

EMEMory

Edit wave being edited in the edit memory is used as a modulating signal.

The argument is reset to SINusoid when the Arbitrary Function Generator is powered on or the \*RST command is sent to this instrument.

**Examples.**

SOURCE1:FM:INTERNAL:FUNCTION SQUARE

sets the modulating waveform to square wave for the CH1 FM modulation.

**[SOURCE<n>]:FM:STATE**

The [SOURCE<n>]:FM:STATE command turns FM modulation on or off for the channel designated by the header suffix.

The [SOURCE<n>]:FM:STATE? query returns ON or OFF status for FM modulation for the channel designated by the header suffix.

When one of the other modulation functions (sweep, AM modulation or FSK modulation) is on, turning FM modulation on will automatically turn off the other modulation function.

On a single-channel instrument, SOURce1 or SOURce header can be valid for designating the channel. If channel 2 is designated on the dual-channel instrument, the SOURce2 header cannot be omitted.

**Group.**

SOURce subsystem Command (SCPI).

**Syntax.**

[SOURce<n>]:FM:STATe {ON|OFF|<NR1>}  
 [SOURce<n>]:FM:STATe?

**Arguments.**

ON or any nonzero value for <NR1>  
 sets FM modulation to ON.

OFF or 0 value for <NR1>  
 sets FM modulation to OFF.

The argument is reset to “0” when the Arbitrary Function Generator is powered on or the \*RST command is sent to this instrument.

**Responses.**

<Response>

<Response>::=<NR1>  
 where <NR1> is a decimal integer as follows;

- 0 FM modulation is currently turned off.
- 1 FM modulation is currently powered on.

**Examples.**

SOURce2:FM:STATe ON  
 turn on CH2 FM modulation.

SOURce1:FM:STATe?  
 might return 1, which indicates that the CH1 FM modulation is powered on.

**[SOURce<n>]:  
 FREQuency[:CW]:FIXed]**

The [SOURce<n>]:FREQuency[:CW]:FIXed] command sets the output frequency for the channel designated by the header suffix in case of other than sweep mode.

The [SOURce<n>]:FREQuency[:CW]:FIXed]? query returns the output frequency for the channel designated by the header suffix in case of other than sweep mode.

On a single-channel instrument, SOURce1 or SOURce header can be valid for designating the channel. If channel 2 is designated on the dual-channel instrument, the SOURce2 header cannot be omitted.

**Group.**

SOURce subsystem Command (SCPI).

**Syntax.**

```
[SOURce<n>]:FREQUency[:CW|:FIXed] <Frequency>
[SOURce<n>]:FREQUency[:CW|:FIXed]? [MINimum|MAXimum]
```

**Arguments.**

<Frequency>::=<NR3>[<unit>]

where

<NR3>           The frequency ranges from 10 mHz to 16 MHz

<unit>::=[Hz|kHz|MHz]

The argument is reset to 100.000 0 kHz when the Arbitrary Function Generator is powered on or the \*RST command is sent to this instrument.

**Responses.**

<Frequency>

<Frequency>::=<NR3>

The response to a query is as follows depending on the argument status:

<Argument>::=<None>   Returns the current setting

<Argument>::=<MINimum>   Returns the value to the available minimum setting

<Argument>::=<MAXimum>   Returns the value to the available maximum setting

**Examples.**

```
SOURce1:FREQUency:FIXed 500kHz
```

sets the CH1 output frequency to 500 kHz in other than sweep mode.

**[SOURce<n>]:  
FREQUency:MODE**

The [SOURce<n>]:FREQUency:MODE command selects the command set used to control frequencies for the channel designated by the header suffix.

The [SOURce<n>]:FREQUency:MODE? query returns the selected command set used to control frequencies for the channel designated by the header suffix.

On a single-channel instrument, SOURce1 or SOURce header can be valid for designating the channel. If channel 2 is designated on the dual-channel instrument, the SOURce2 header cannot be omitted.

**Group.**

SOURce subsystem Command (SCPI).

**Syntax.**

[SOURce<n>]:FREQuency:MODE {CW|FIXed|SWEep}  
 [SOURce<n>]:FREQuency:MODE?

**Arguments.**

CW|FIXed

The frequency is controlled to the value set by the [SOURce<n>]:FREQuency[:CW|:FIXed] command (and sweep modulation is turned off).

SWEep

The frequency is controlled to the values set by the [SOURce<n>]:FREQuency:STARt and [SOURce<n>]:FREQuency:STOP commands (and sweep modulation is powered on).

The argument is reset to FIXed when the Arbitrary Function Generator is powered on or the \*RST command is sent to this instrument.

**Responses.**

<Response>

<Response>::=<String>

The response to the query is as follows:

|          |  |
|----------|--|
| CW FIXed | Controls the frequency with the [SOURce<n>]:FREQuency[:CW :FIXed] command. |
| SWEep    | Controls the frequency with the sweep command set.                         |

**Examples.**

SOURce1:FREQuency:MODE SWEep  
 specifies the sweep command set for controlling the CH1 output frequency.

**[SOURce<n>]:  
 FREQuency:STARt**

The [SOURce<n>]:FREQuency:STARt command sets the start frequency of sweep modulation for the channel designated by the header suffix.

The [SOURce<n>]:FREQuency:STARt? query returns the sweep start frequency for the channel designated by the header suffix.

On a single-channel instrument, SOURce1 or SOURce header can be valid for designating the channel. If channel 2 is designated on the dual-channel instrument, the SOURce2 header cannot be omitted.

**Group.**

SOURce subsystem Command (SCPI).

**Syntax.**

```
[SOURce<n>]:FREQuency:STARt <Start Frequency>
[SOURce<n>]:FREQuency:STARt? [MINimum|MAXimum]
```

**Arguments.**

<Start Frequency>::=<NR3>[<unit>]

where

<unit>::=[Hz|kHz|MHz]

<NR3>

The setting range for <Start frequency> is one of the following depending on the waveform for the sweep operation:

|                                |                   |
|--------------------------------|-------------------|
| SINusoid and SQUare            | 10 mHz to 16 MHz  |
| Other than SINusoid and SQUare | 10 mHz to 100 kHz |

The argument is reset to 1.000 0 kHz when the Arbitrary Function Generator is powered on or the \*RST command is sent to this instrument.

**Responses.**

<Start Frequency>

<Start Frequency>::=<NR3>

The response to a query is as follows depending on the argument status:

<Argument>::=<None> Returns the current setting

<Argument>::=<MINimum> Returns the value to the available minimum setting

<Argument>::=<MAXimum> Returns the value to the available maximum setting

**Examples.**

```
SOURce1:FREQuency:STARt 500kHz
```

sets the start frequency to 500 kHz for the CH1 sweep when sine wave is selected.

**[SOURce<n>]:  
FREQuency:STOP**

The [SOURce<n>]:FREQuency:STOP command sets the stop frequency of sweep modulation for the channel designated by the header suffix.

The [SOURce<n>]:FREQuency:STOP? query returns the sweep stop frequency for the channel designated by the header suffix.





The [SOURCE<n>]:FSKey[:FREQUENCY]? query returns the FSK hop frequency for the channel designated by the header suffix.

On a single-channel instrument, SOURCE1 or SOURCE header can be valid for designating the channel. If channel 2 is designated on the dual-channel instrument, the SOURCE2 header cannot be omitted.

### Group.

SOURCE subsystem Command (nonSCPI).

### Syntax.

```
[SOURCE<n>]:FSKey[:FREQUENCY] <Hop Frequency>
[SOURCE<n>]:FSKey[:FREQUENCY]? [MINimum|MAXimum]
```

### Arguments.

<Hop Frequency>::=<NR3>[<unit>]

where

<unit>::=[Hz|kHz|MHz]

<NR3>

The setting range for <Hop frequency> is one of the following depending on the carrier waveform:

|                                |                   |
|--------------------------------|-------------------|
| SINusoid and SQUare            | 10 mHz to 16 MHz  |
| Other than SINusoid and SQUare | 10 mHz to 100 kHz |

The argument is reset to 10.000 00 kHz when the Arbitrary Function Generator is powered on or the \*RST command is sent to this instrument.

### Responses.

<Hop Frequency>

<Hop Frequency>::=<NR3>

The response to a query is as follows depending on the argument status:

<Argument>::=<None> Returns the current setting

<Argument>::=<MINimum> Returns the value to the available minimum setting

<Argument>::=<MAXimum> Returns the value to the available maximum setting

### Examples.

```
SOURCE1:FSKey:FREQUENCY 1 MHz
```

sets the Hop frequency to 1 MHz for the CH1 FSK modulation when sine wave is selected as the carrier wave.

**[SOURCE<n>]:  
FSKey:INTernal:RATE**

The [SOURCE<n>]:FSKey:INTernal:RATE command sets the key switching frequency at which the output frequency moves between the carrier frequency and the “Hop” frequency for the channel designated by the header suffix.

The [SOURCE<n>]:FSKey:INTernal:RATE? query returns the key switching frequency for the channel designated by the header suffix.

On a single-channel instrument, SOURCE1 or SOURCE header can be valid for designating the channel. If channel 2 is designated on the dual-channel instrument, the SOURCE2 header cannot be omitted.

**Group.**

SOURCE subsystem Command (nonSCPI).

**Syntax.**

[SOURCE<n>]:FSKey:INTernal:RATE <Hop Rate>  
[SOURCE<n>]:FSKey:INTernal:RATE? [MINimum]MAXimum]

**Arguments.**

<Hop Rate>::=<NR3>[<unit>]

where

<NR3>           The key switching frequency ranges from 10 mHz to 50 kHz  
<unit>::=[Hz|kHz]

The argument is reset to 1.000 kHz when the Arbitrary Function Generator is powered on or the \*RST command is sent to this instrument.

**Responses.**

<Hop Rate>

<Hop Rate>::=<NR3>

The response to a query is as follows depending on the argument status:

<Argument>::=<None>     Returns the current setting

<Argument>::=<MINimum>   Returns the value to the available minimum setting

<Argument>::=<MAXimum>   Returns the value to the available maximum setting

**Examples.**

SOURCE1:FSKey:INTernal:RATE 10kHz

sets the key switching frequency to 10 kHz for the CH1 FSK modulation.

**[SOURCE<n>]:  
FSKey:STate**

The [SOURCE<n>]:FSKey:STate command turns FSK modulation on or off for the channel designated by the header suffix.

The [SOURCE<n>]:FSKey:STATe? query returns ON or OFF status for FSK modulation for the channel designated by the header suffix.

When one of the other modulation functions (sweep, AM modulation or FM modulation) is on, turning FSK modulation on will automatically turn off the other modulation function.

On a single-channel instruments, SOURCE1 or SOURCE header can be valid for designating the channel. If channel 2 is designated on the dual-channel instrument, the SOURCE2 header cannot be omitted.

### Group.

SOURCE subsystem Command (nonSCPI).

### Syntax.

```
[SOURCE<n>]:FSKey:STATe {<ON|OFF|NR1>}
[SOURCE<n>]:FSKey:STATe?
```

### Arguments.

ON or any nonzero value for <NR1>  
sets FSK modulation to ON.

OFF or 0 value for <NR1>  
sets FSK modulation to OFF.

The argument is reset to “0” when the Arbitrary Function Generator is powered on or the \*RST command is sent to this instrument.

### Responses.

<Response>

<Response>::=<NR1>

where <NR1> is a decimal integer as follows;

|   |  |
|---|--|
| 0 | FSK modulation is currently powered off. |
| 1 | FSK modulation is currently powered on.  |

### Examples.

SOURCE2:FSKey:STATe ON  
turn on CH2 FSK modulation.

SOURCE1:FSKey:STATe?  
might return 1, which indicates CH1 FSK modulation is powered on.

**[SOURce<n>]:  
FUNCTion[:SHAPE]**

The [SOURce<n>]:FUNCTion[:SHAPE] command sets the shape of the output waveform for the channel designated by the header suffix.

The [SOURce<n>]:FUNCTion[:SHAPE]? query returns the shape of the output waveform for the channel designated by the header suffix.

On a single-channel instrument, SOURce1 or SOURce header can be valid for designating the channel. If channel 2 is designated on the dual-channel instrument, the SOURce2 header cannot be omitted.

**Group.**

SOURce subsystem Command (SCPI).

**Syntax.**

```
[SOURce<n>]:FUNCTion[:SHAPE] {SINusoid|SQUare|TRIangle|RAMP|  
PULSe|PRNoise|DC|USER[1]|USER2|USER3|USER4|EMEMo-  
ry}  
[SOURce<n>]:FUNCTion[:SHAPE]?
```

**Arguments.**

SINusoid|SQUare|TRIangle|RAMP|PULSe|PRNoise|DC

One of 7 types of function wave can be select for the output waveform.

USER[1]|USER2|USER3|USER4

User wave saved in the user waveform memory is set for the output waveform.

EMEMory

Edit wave being edited in the edit memory is set for the output waveform.

The argument is reset to SINusoid when the Arbitrary Function Generator is powered on or the \*RST command is sent to this instrument.

**Examples.**

SOURce1:FUNCTion:SHAPE SQUARE  
sets the CH1 output waveform to square wave.

**[SOURce<n>]:  
PHASe[:ADJust]**

The [SOURce<n>]:PHASe[:ADJust] command sets the phase for the output signal for the channel designated by the header suffix.

The [SOURce<n>]:PHASe[:ADJust]? query returns the phase for the output signal for the channel designated by the header suffix.

On a single-channel instrument, SOURce1 or SOURce header can be valid for designating the channel. If channel 2 is designated on the dual-channel instrument, the SOURce2 header cannot be omitted.

**Group.**

SOURCE subsystem Command (SCPI).

**Syntax.**

```
[SOURCE<n>]:PHASE[:ADJUST] <Phase>
[SOURCE<n>]:PHASE[:ADJUST]? [MINimum|MAXimum]
```

**Arguments.**

<Phase>::=<NR2>[<unit>]

where

<NR2> is a decimal number that must range as follows depending on the unit specified by the argument suffix:

DEG    -360 to +360, in steps of 1 degree, relative phase value

RAD    -2PI to +2PI, relative phase value

<unit>::={DEG|RAD}

If <unit> is omitted, DEG is specified automatically.

The argument is reset to 0 degree when the Arbitrary Function Generator is powered on or the \*RST command is sent to this instrument.

**Responses.**

<Phase>

<Phase>::=<NR2>

The response to a query is as follows depending on the argument status:

<Argument>::=<None>    Returns the current setting

<Argument>::=<MINimum>    Returns the value to the available minimum setting

<Argument>::=<MAXimum>    Returns the value to the available maximum setting

**Examples.**

SOURCE1:PHASE:ADJUST 90DEG

changes the CH1 output signal phase by 90 degrees.

**[SOURCE<n>]:  
PULSE:DCYCLE**

The [SOURCE<n>]:PULSE:DCYCLE command sets the duty cycle for the pulse wave for the channel designated by the header suffix.

The [SOURCE<n>]:PULSE:DCYCLE? query returns the duty cycle for the pulse wave for the channel designated by the header suffix.

This command is only valid for pulse wave. Duty cycle represents the amount of time per cycle that the pulse wave is high.

On a single-channel instrument, SOURce1 or SOURce header can be valid for designating the channel. If channel 2 is designated on the dual-channel instrument, the SOURce2 header cannot be omitted.

**Group.**

SOURce subsystem Command (SCPI).

**Syntax.**

[SOURce<n>]:PULSe:DCYClE <Duty>  
 [SOURce<n>]:PULSe:DCYClE? [MINimum|MAXimum]

**Arguments.**

<Duty>::=<NR1>[<unit>]

where

<unit>::=PCT

<NR1> is a decimal number that must range from 1 % to 99 %, in increments of 1 %.

The argument is reset to 50 % when the Arbitrary Function Generator is powered on or the \*RST command is sent to this instrument.

**Responses.**

<Phase>

<Duty>::=<NR1>

The response to a query is as follows depending on the argument status:

<Argument>::=<None> Returns the current setting

<Argument>::=<MINimum> Returns the value to the available minimum setting

<Argument>::=<MAXimum> Returns the value to the available maximum setting

**Examples.**

SOURce1:PULSe:DCYClE 25PCT  
 sets the duty cycle to 25 % for the CH1 pulse wave.

**[SOURce<n>]:  
 SWEp:TIME**

The [SOURce<n>]:SWEp:TIME command sets the sweep time for the channel designated by the header suffix.

The [SOURce<n>]:SWEp:TIME? query returns the sweep time for the channel designated by the header suffix.

Sweep time represents the amount of time required to sweep from the start frequency to the stop frequency.

On a single-channel instrument, SOURce1 or SOURce header can be valid for designating the channel. If channel 2 is designated on the dual-channel instrument, the SOURce2 header cannot be omitted.

**Group.**

SOURce subsystem Command (SCPI).

**Syntax.**

```
[SOURce<n>]:SWEep:TIME <Sweep Time>
[SOURce<n>]:SWEep:TIME? [MINimum|MAXimum]
```

**Arguments.**

<Sweep Time>::=<NR3>[<unit>]

where

<unit>::={ms|s}

<NR3> is a decimal number that must range from 1 ms to 500 s.

The argument is reset to 1.000 s when the Arbitrary Function Generator is powered on or the \*RST command is sent to this instrument.

**Responses.**

<Phase>

<Sweep Time>::=<NR3>

The response to a query is as follows depending on the argument status:

<Argument>::=<None> Returns the current setting

<Argument>::=<MINimum> Returns the value to the available minimum setting

<Argument>::=<MAXimum> Returns the value to the available maximum setting

**Examples.**

SOURce1:SWEep:TIME 10s  
sets the CH1 sweep time to 10 s.

**[SOURce<n>]:  
SWEep:SPACing**

The [SOURce<n>]:SWEep:SPACing command selects linear or logarithmic spacing for the sweep for the channel designated by the header suffix.

The [SOURce<n>]:SWEep:SPACing? query returns “LIN” or “LOG” for the sweep spacing for the channel designated by the header suffix.

The sweep output frequency is varied in steps. When linear is selected, the frequency is varied by a fixed amount for each step. When log is selected, the frequency is changed logarithmically for each step.

On a single-channel instrument, SOURce1 or SOURce header can be valid for designating the channel. If channel 2 is designated on the dual-channel instrument, the SOURce2 header cannot be omitted.

**Group.**

SOURce subsystem Command (SCPI).

**Syntax.**

[SOURce<n>]:SWEep:SPACing {LINear|LOGarithmic}  
 [SOURce<n>]:SWEep:SPACing? [MINimum|MAXimum]

**Arguments.**

LINear sets the sweep spacing to linear.  
 LOGarithmic sets the sweep spacing to logarithmic.

**Examples.**

SOURce1:SWEep:SPACing LINear  
 sets the CH1 sweep spacing to linear.

**[SOURce<n>]:  
 VOLTage[:LEVel][:  
 IMMEDIATE]:AMPLitude**

The [SOURce<n>]:VOLTage[:LEVel][:IMMEDIATE]:AMPLitude command sets the output amplitude for the currently selected waveform for the channel designated by the header suffix.

The [SOURce<n>]:VOLTage[:LEVel][:IMMEDIATE]:AMPLitude? query returns the output amplitude for the currently selected waveform for the channel designated by the header suffix.

On a single-channel instrument, SOURce1 or SOURce header can be valid for designating the channel. If channel 2 is designated on the dual-channel instrument, the SOURce2 header cannot be omitted.

**Group.**

SOURce subsystem Command (SCPI).

**Syntax.**

[SOURce<n>]:VOLTage[:LEVel][:IMMEDIATE]:AMPLitude <Amplitude>  
 [SOURce<n>]:VOLTage[:LEVel][:IMMEDIATE]:AMPLitude?  
 [MINimum|MAXimum]

**Arguments.**

<Amplitude>::=<NR2>[<unit>]  
 where



<unit>::={mV|V}

<NR2> is a decimal number that must range from 0 V<sub>p-p</sub> to 10 V<sub>p-p</sub>.

The argument is reset to 1.000 V when the Arbitrary Function Generator is powered on or the \*RST command is sent to this instrument.

### Responses.

<Amplitude>

<Amplitude>::=<NR2>

The response to a query is as follows depending on the argument status:

<Argument>::=<None> Returns the current setting

<Argument>::=<MINimum> Returns the value to the available minimum setting

<Argument>::=<MAXimum> Returns the value to the available maximum setting

### Examples.

SOURce1:VOLTage:LEVel:IMMEDIATE:AMPLitude 2V  
sets the CH1 output amplitude to 2 V<sub>p-p</sub>.

### **[SOURce<n>]: VOLTage[:LEVel][: IMMEDIATE]:OFFSet**

The [SOURce<n>]:VOLTage[:LEVel][:IMMEDIATE]:OFFSet command sets the DC offset for the currently selected waveform for the channel designated by the header suffix.

The [SOURce<n>]:VOLTage[:LEVel][:IMMEDIATE]:OFFSet? query returns the DC offset for the currently selected waveform for the channel designated by the header suffix.

On a single-channel instrument, SOURce1 or SOURce header can be valid for designating the channel. If channel 2 is designated on the dual-channel instrument, the SOURce2 header cannot be omitted.

### Group.

SOURce subsystem Command (SCPI).

### Syntax.

[SOURce<n>]:VOLTage[:LEVel][:IMMEDIATE]:OFFSet <Offset>  
[SOURce<n>]:VOLTage[:LEVel][:IMMEDIATE]:OFFSet? [MINimum|MAXimum]

### Arguments.

<Offset>::=<NR2>[<unit>]

where

<unit>::={mV|V}

<NR2> is a decimal number that must range from -5 V to +5 V.

The argument is reset to 0.000 V when the Arbitrary Function Generator is powered on or the \*RST command is sent to this instrument.

**Responses.**

<Offset>

<Offset>::=<NR2>

The response to a query is as follows depending on the argument status:

<Argument>::=<None> Returns the current setting

<Argument>::=<MINimum> Returns the value to the available minimum setting

<Argument>::=<MAXimum> Returns the value to the available maximum setting

**Examples.**

SOURce1:VOLTage:LEVel:IMMediate:OFFSet 2V

sets the CH1 output DC offset to 2 V.

**\*SRE** The \*SRE common command sets the bits of the SRER (Service Request Enable Register).

The \*SRE? common query returns the contents of SRER.

**Group.**

IEEE-488.2 Common Command.

**Syntax.**

\*SRE <Bit Value>

**Arguments.**

<Bit Value>::=<NR1>

where the argument must be decimal number from 0 to 255. The SRER bits are set in binary bit according to the decimal number.

The power-on default for the ESER is to reset all bits to zero.

**Examples.**

\*SRE 48

sets the SRER to 48 (binary 00110000), which sets the ESB and MAV bits.

\*SRE?

might return 32 which indicates that the SRER contains the binary number 00100000.

**STATus:  
OPERation:CONDition?  
(Query Only)**

The STATus:OPERation:CONDition? query returns the contents of the Operation Condition Register.

**Group.**

STATus subsystem Command (SCPI).

**Syntax.**

STATus:OPERation:CONDition?

**Responses.**

<OCR-bits>::=<NR1>

where <NR1> must be returned in decimal number according to the binary data in the OCR.

**Examples.**

STATus:OPERation:CONDition?

might return 32 which indicates that the OCR contains the binary number 00000000 00100000 and the instrument is waiting for trigger.

**STATus:  
OPERation:ENABLE**

The STATus:OPERation:ENABle command sets the mask for the Operation Enable Register.

The STATus:OPERation:ENABle? query returns the value of the mask for the Operation Enable Register.

**Group.**

STATus subsystem Command (SCPI).

**Syntax.**

STATus:OPERation:ENABle <Bit Value>  
STATus:OPERation:ENABle?

**Arguments.**

<Bit Value>::=<NRf> or nondecimal data

**Responses.**

<OENR-bits>::=<NR1>

where <NR1> must be returned in decimal number according to the binary data in the OENR.

**Examples.**

STATus:OPERation:ENABle #H0008  
sets the SWEeping bit in the OENR to “enable”.

STATus:OPERation:ENABle?  
might return 8 which indicates that the OENR contains the binary number 00000000 00001000 and the SWE bit is set to “enable”.

**STATus:  
OPERation[:EVENT]?  
(Query Only)**

The STATus:OPERation[:EVENT]? query returns the value in the Operation Event Register and clears the Operation Event Register.

**Group.**

STATus subsystem Command (SCPI).

**Syntax.**

STATus:OPERation[:EVENT]?

**Responses.**

<OEVR–bits>::=<NR1>  
where <NR1> must be returned in decimal number according to the binary data in the OEVR.

**Examples.**

STATus:OPERation:EVENT?  
might return 8 which indicates that the OEVR contains the binary number 00000000 00001000 and the SWE bit is set to “enable”.

**STATus:PRESet  
(Command Only)**

The STATus:PRESet command presets the SCPI status registers (OENR and QENR).

**Group.**

STATus subsystem Command (SCPI).

**Syntax.**

STATus:PRESet

**STATUS:  
QUESTIONable:CONDition?  
(Query Only)**

**Examples.**

STATUS:PRESet  
presets the SCPI status registers.

The STATUS:QUESTIONable:CONDition? query returns the contents of the Questionable Condition Register.

**Group.**

STATUS subsystem Command (SCPI).

**Syntax.**

STATUS:QUESTIONable:CONDition?

**Responses.**

<QCR-bits>

<QCR-bits>::=<NR1>

where <NR1> must be returned in decimal number according to the binary data in the QCR.

**Examples.**

STATUS:QUESTIONable:CONDition?  
might return 256 which indicates that the QCR contains the binary number 00000001 00000000 and the calibration is completed with some errors.

**STATUS:  
QUESTIONable:ENABLE**

The STATUS:QUESTIONable:ENABLE command sets the mask for the Questionable Enable Register.

The STATUS:QUESTIONable:ENABLE? query returns the value of the mask for the Questionable Enable Register.

**Group.**

STATUS subsystem Command (SCPI).

**Syntax.**

STATUS:QUESTIONable:ENABLE <Bit Value>  
STATUS:QUESTIONable:ENABLE?

**Arguments.**

<Bit Value>::=<NRf> or nondecimal data

**Responses.**

<QENR–bits>::=<NR1>

where <NR1> must be returned in decimal number according to the binary data in the QENR.

**Examples.**

STATus:QUESTionable:ENAbLe #H0100  
sets the CALibration bit in the QENR to “enable”.

STATus:QUESTionable:ENAbLe?  
might return 256 which indicates that the QENR contains the binary number 00000001 00000000 and the CAL bit is set to “enable”.

**STATus:  
QUESTionable[:EVENT]?  
(Query Only)**

The STATus:QUESTionable[:EVENT]? query returns the value in the Questionable Event Register and clears the Questionable Event Register.

**Group.**

STATus subsystem Command (SCPI).

**Syntax.**

STATus:QUESTionable[:EVENT]?

**Responses.**

<QEVr–bits>::=<NR1>

where <NR1> must be returned in decimal number according to the binary data in the QEVr.

**Examples.**

STATus:QUESTionable:EVENT?  
might return 256 which indicates that the QEVr contains the binary number 00000001 00000000 and the CALibration bit is set to “enable”.

**STATus:QUEue[:NEXT]?  
(Query Only)**

The STATus:QUEue[:NEXT]? query retrieves and returns error data from the Error and Event Queue. It has the same function as the SYSTem:ERRor? query.

**Group.**

STATus subsystem Command (SCPI).

**Syntax.**

STATus:QUEue[:NEXT]?

**Responses.**

<Response>::=<Error/event number>,"<Error/event description>[;<Device dependent info>]"

where

<Error/event number> is an integer between -32768 and 32767.

Negative values are error/event numbers reserved in SCPI standards.

Positive values are error/event numbers determined by this instrument.

0 indicates that no error or event has occurred.

<Error/event description> is a message relating to the error/event number.

<Device dependent info> is more detailed information relating to the error/event number.

**Examples.**

STATus:QUEue[:NEXT]?

might return the following response:

-102,"Syntax error;possible invalid – :SOUR:FREQ 2V"

In the example shown above, the unit is invalid.

**\*STB?  
(Query Only)****Group.**

IEEE-488.2 Common Command.

**Syntax.**

\*STB?

The \*STB? common query returns the value of the SBR (Status Byte Register).

At this time, bit 6 of the SBR is read as a MSS (Master Status Summary) bit.

**Responses.**

<NR1>

which is a decimal number.

**Examples.**

\*STB?

might return 96, which indicates that the SBR contains the binary number 01100000.

**SYSTEM:BEEPer:STATe**

The SYSTem:BEEPer:STATe command sets the beep sound to on or off.

The SYSTem:BEEPer:STATe? query returns the beep sound setting.

**Group.**

SYSTem subsystem Command (SCPI).

**Syntax.**

SYSTem:BEEPer:STATe {ON|OFF|<NR1>}  
 SYSTem:BEEPer:STATe?

**Arguments.**

ON or any nonzero value for <NR1>  
 sets the beep sound to ON.

OFF or 0 value for <NR1>  
 sets the beep sound to OFF.

**Responses.**

<Response>::=<NR1>  
 where <NR1> is a decimal integer as follows;

- 0                   the beep sound is currently turned off.
- 1                   the beep sound is currently powered on.

**Examples.**

SYSTem:BEEPer:STATe ON  
 turns on the beep sound.

SYSTem:BEEPer:STATe?  
 might return 1, which indicates that the beep sound is set to ON state.

**SYSTem:ERRor?  
 (Query Only)**

The SYSTem:ERRor? query retrieves and returns error data from the Error and Event Queue. It has the same function as the STATus:QUEue[:NEXT]? query.

**Group.**

SYSTem subsystem Command (SCPI).

**Syntax.**

SYSTem:ERRor?

**Responses.**

<Response>::=<Error/event number>,"<Error/event  
 description>[:<Device dependent info>]"

where  
 <Error/event number> is an integer between -32768 and 32767.  
 Negative values are error/event numbers reserved in SCPI standards.



Positive values are error/event numbers determined by this instrument.  
0 indicates that no error or event has occurred.

<Error/event description> is a message relating to the error/event number.

<Device dependent info> is more detailed information relating to the error/event number.

**Examples.**

SYSTem:ERRor?

might return the following response:

-102,"Syntax error;possible invalid – :SOUR:FREQ 2V"

In the example shown above, the unit is invalid.

**SYSTem:KLOCK**

The SYSTem:KLOCK command locks or unlocks the functions of the keys on the front panel.

The SYSTem:KLOCK? query returns whether or not the functions of the keys on the front panel are locked.

If the key functions are locked, operation from the front panel is not possible.

**Group.**

SYSTem subsystem Command (SCPI).

**Syntax.**

SYSTem:KLOCK {ON|OFF|<NR1>}

SYSTem:KLOCK?

**Arguments.**

ON or any nonzero value for <NR1>  
locks the key control on the front panel.

OFF or 0 value for <NR1>  
unlocks the key control on the front panel.

**Responses.**

<Response>::=<NR1>

where <NR1> is a decimal integer as follows;

|   |   |
|---|---|
| 0 | the key control on the front panel is currently unlocked. |
| 1 | the key control on the front panel is currently locked.   |

**Examples.**

SYSTem:KLOCK ON

locks the key control on the front panel.

SYSTem:KLOCK?

might return 1, which indicates that the key control on the front panel is locked.

**SYSTem:  
SECurity:IMMEDIATE  
(Command Only)**

The SYSTem:SECurity:IMMEDIATE command initializes the user waveform memory, edit memory, settings memory, and returns all settings to their factory default (secure) values.

The system menu items (GPIB ADDRESS, STEP RECALL, LAST RECALL STEP, KEY CLICK, BEEP, LOCK WAVE and UNLOCK WAVE) are also initialized to their factory settings.

**Group.**

SYSTem subsystem Command (SCPI).

**Syntax.**

SYSTem:SECurity:IMMEDIATE

**Examples.**

SYSTem:SECurity:IMMEDIATE

initializes the user waveform memory, edit memory, settings memory, and returns all settings to their factory default (secure) values.

**SYSTem:SRECall[:STATe]**

The SYSTem:SRECall[:STATe] command sets the step recall mode to on or off.

The SYSTem:SRECall[:STATe]? query returns the step recall mode setting.

**Group.**

SYSTem subsystem Command (nonSCPI).

**Syntax.**

SYSTem:SRECall[:STATe] {ON|OFF|<NR1>}

SYSTem:SRECall[:STATe]?

**Arguments.**

ON or any nonzero value for <NR1>

sets the step recall mode to ON.

OFF or 0 value for <NR1>

sets the step recall mode to OFF.

**Responses.**

<Response>::=<NR1>

where <NR1> is a decimal integer as follows;

- |   |   |
|---|---|
| 0 | the step recall mode is currently turned off. |
| 1 | the step recall mode is currently powered on. |

**Examples.**

SYSTem:SRECall:STATe ON  
turns on the step recall mode.

SYSTem:SRECall:STATe?  
might return 1, which indicates that the step recall mode is set to ON state.

**SYSTem:ULIMit**

The SYSTem:ULIMit command sets the upper limit for the setting memory number in STEP RECALL mode.

The SYSTem:ULIMit? query returns the upper limit for the setting memory number in STEP RECALL mode.

**Group.**

SYSTem subsystem Command (nonSCPI).

**Syntax.**

SYSTem:ULIMit <Memory Number>  
SYSTem:ULIMit? [MINimum|MAXimum]

**Arguments.**

<Memory Number>::=<NR1>

where <NR1> is the upper limit for the setting memory number in STEP RECALL mode and ranges from 1 to 19.

**Examples.**

SYSTem:ULIMit 5  
sets the upper limit memory number to 5.

SYSTem:ULIMit?  
might return 5, which indicates that the upper limit memory number is 5.

**SYSTem:VERSion?  
(Query Only)**

The SYSTem:VERSion? query returns the conformed SCPI version of the Arbitrary Function Generator.

**Group.**

SYSTem subsystem Command (SCPI).

**Syntax.**

SYSTem:VERSion?

**Responses.**

<SCPI Version>::=YYYY.Z

where

YYYY            Indicates the year.

Z                Indicates the version number for that year.

**Examples.**

SYSTem:VERSion?

might return 1994.0.

**TRACe|DATA:CATalog?  
(Query Only)**

The TRACe|DATA:CATalog? query returns the user waveform memory names and the edit memory name.

**Group.**

TRACe|DATA subsystem Command (SCPI).

**Syntax.**

TRACe|DATA:CATalog?

**Responses.**

<String>,<String>,<String>,<String>,<String>

A series of strings separated by commas is returned. Each string is enclosed within quotation marks.

**Examples.**

DATA:CATalog?

might return "USER","USER2","USER3","USER4","EMEM"

**TRACe|DATA:COPY  
(Command Only)**

The TRACe|DATA:COPY command copies the content of the edit memory to the specified user waveform memory.

An error will occur if the destination user waveform memory is locked.

**Group.**

TRACe|DATA subsystem Command (SCPI).

**Syntax.**

TRACe|DATA:COPY <Trace Name>,EMEMory

**Arguments.**

<Trace Name>::={USER[1]|USER2|USER3|USER4}

where <Trace Name> is the destination file name.

**Examples.**

DATA:COPY USER1,EMEMory

copies the waveform data in the edit memory to the user waveform memory USER1.

**TRACe|DATA[:DATA]  
(Command Only)**

The TRACe|DATA[:DATA] command transfers the waveform data from the external controller to the edit memory in the Arbitrary Function Generator.

**Group.**

TRACe|DATA subsystem Command (SCPI).

**Syntax.**

TRACe|DATA[:DATA] EMEMory,<Block>

**Arguments.**

<Block>::=<Arbitrary Block>

where <Arbitrary Block> is the unscaled waveform data in binary format.

Each data point <Block> that ranges from 0 to 4094 is transferred as an unsigned integer code of two bytes with an effective bit length of 12 bits. The byte order for the point data is designated by the FORMat:BORDER command.

**Examples.**

DATA:DATA EMEMory,#42000<DAB><DAB>.....<DAB>

transmits an unscaled waveform to the edit memory in the Arbitrary Function Generator. The block data element #42000 indicates that 4 is the number of digits in 2000 (byte count) and the 2000 bytes of binary data are to be transmitted.

**TRACe|DATA[:DATA]:LINE  
(Command Only)**

The TRACe|DATA[:DATA]:LINE command writes line data to the edit memory. The data between the designated points is interpolated linearly.

**Group.**

TRACe|DATA subsystem Command (SCPI).

**Syntax.**

TRACe|DATA[:DATA]:LINE EMEMory,<Start Point>,<Point Data>,  
 <End Point>,<Point Data>

**Arguments.**

<Start Point>::=<NR1>

where <NR1> is the first point from which the data is interpolated linearly.

<End Point>::=<NR1>

where <NR1> is the last point to which the data is interpolated linearly.

<Point Data>::=<NR1>

where <NR1> is the data value at the start point or the end point.

**Examples.**

DATA:DATA:LINE EMEMory,1,2047,250,4094

sets a data value of 2047 for start point 1 and a data value of 4094 for end point 250, and interpolates linearly between these two points in the edit memory.

**TRACe|DATA[:DATA]:  
VALue**

The TRACe|DATA[:DATA]:VALue writes a data value at the designated points in the edit memory.

The TRACe|DATA[:DATA]:VALue? query returns the data value at the designated points in the edit memory.

**Group.**

TRACe|DATA subsystem Command (SCPI).

**Syntax.**

TRACe|DATA[:DATA]:VALue EMEMory,<Data Point>,<Data Value>,  
 TRACe|DATA[:DATA]:VALue? EMEMory,<Data Point>

**Arguments.**

<Data Point>::=<NR1>

where <NR1> is the designated point number in the edit memory.

<Data Value>::=<NR1>

where <NR1> is the data value for the designated point number.

**Examples.**

DATA:DATA:VALue EMEMory,500,2047

sets the data value to 2047 for the point number 500 in the edit memory.

**TRACe|DATA:DEFine  
(Command Only)**

The TRACe|DATA:DEFine command initialize the edit memory.

**Group.**

TRACe|DATA subsystem Command (SCPI).

**Syntax.**

TRACe|DATA:DEFine EMEMory[, {<Num of Points>|<Trace Name>}]

**Arguments.**

<Num of Point>::=<NR1>

where <NR1> is the number of points in the edit memory that ranges from 10 to 16 384.

If the second parameter in the argument is a numerical value, the length of the edit memory will be the number of points designated by this number and each point will be initialized to the default value (2047).

<Trace Name>::={USER[1]|USER2|USER3|USER4}

is the name of the user waveform memory.

If the second parameter in the argument is the name of the user waveform memory, the contents of the user waveform memory will be copied to the edit memory.

If the second parameter in the argument is omitted, the edit memory will be initialized to the default number of points (1000) and value (2047).

**Examples.**

DATA:DEFine EMEMory,1000

sets the length of the edit memory to 1000 points and initializes the data points to the default value 2047.

**TRACe|DATA:  
LOCK[:STATe]**

The TRACe|DATA:LOCK[:STATe] command locks or unlocks the user waveform memory.

The TRACe|DATA:LOCK[:STATe]? query returns the status (locked or unlocked) of the user waveform memory.

**Group.**

TRACe|DATA subsystem Command (nonSCPI).

**Syntax.**

STRACe|DATA:LOCK[:STATe] <Trace Name>,{ON|OFF|<NR1>}

STRACe|DATA:LOCK[:STATe]? <Trace Name>

**Arguments.**

<Trace Name> ::= USER[1]|USER2|USER3|USER4  
 designates a user waveform memory to be locked or unlocked.

ON or any nonzero value for <NR1>  
 locks the user waveform memory designated with <Trace Name>.

OFF or 0 value for <NR1>  
 unlocks the user waveform memory designated with <Trace Name>.

**Responses.**

<Response> ::= <NR1>  
 where <NR1> is a decimal integer as follows;

- 0                    the specified user waveform memory is currently unlocked.
- 1                    the specified user waveform memory is currently locked..

**Examples.**

DATA:LOCK:STATe USER1,ON  
 locks the USER1 waveform memory.

DATA:LOCK:STATe? USER1  
 returns 1, which indicates that the USER1 waveform memory is locked.

**TRACe|DATA:POINts**

The TRACe|DATA:POINts command sets the number of data points of the waveform created in the edit memory.

The TRACe|DATA:POINts? query returns the number of data points in the waveform.

**Group.**

TRACe|DATA subsystem Command (SCPI).

**Syntax.**

TRACe|DATA:POINts EMEMory,<Num of Points>  
 TRACe|DATA:POINts?EMEMory

**Arguments.**

<Num of Points> ::= <NR1>  
 where <NR1> sets the number of points of the waveform created in the edit memory. The number of points ranges from 10 to 16,384.

If the second parameter <Num of Point> in the argument is omitted, the edit memory will be set to the default number of points (1000).



**Examples.**

DATA:POINts EMEMory,500

sets the waveform data points to 500 in the edit memory.

**\*TRG  
(Command Only)**

The \*TRG common command generates trigger event.

**Group.**

IEEE-488.2 Common Command.

**Syntax.**

\*TRG

**Examples.**

\*TRG

generates trigger event.

**\*TST?  
(Query Only)**

The \*TST? common query performs a self test and returns status a that indicates whether the Arbitrary Function Generator completes the self test without error.

**Group.**

IEEE-488.2 Common Command.

**Syntax.**

\*TST?

**Responses.**

<Result>

where <Result>::=<NR1>, which is one of following decimal integers:

|     |                           |
|-----|---------------------------|
| 0   | Terminated without error. |
| 500 | Self test error           |
| 501 | Flash memory error        |
| 502 | Control memory error      |
| 503 | Waveform memory error     |
| 504 | GPIB interface error      |

If errors are detected during self test, the error code for the first error to be discovered is returned.

---

**NOTE.** *Up to 20 seconds are required to complete the self test for the Arbitrary Function Generator. During this time, the Arbitrary Function Generator does not respond to any commands or queries issued.*

---

**Examples.**

\*TST?

performs an internal self test and returns the results (for example, it might return 0, which indicates the self test terminated without any detected errors).

**\*WAI  
(Command Only)**

The \*WAI common command prevents the Arbitrary Function Generator from executing any further commands or queries until all pending operations are completed.

**Group.**

IEEE-488.2 Common Command

**Syntax.**

\*WAI

**Examples.**

\*WAI

prevents the execution of any commands or queries until all pending operations are complete.

## Programming Examples

This section describes example programs in Quick BASIC that illustrate methods that you can use to control the Arbitrary Function Generator over the GPIB interface.

The programs run on PC compatible systems equipped with a National Instruments GPIB board and associated drivers.

All the example programs assume that the GPIB system recognizes the instrument as DEV1 and the PC (external controller) as GPIB0 and also recognizes the address number of DEV1 as 1 and GPIB0 as 0.

**Example 1: Set up a  
Waveform Output**

The first example illustrates setting up Arbitrary a Function Generator for output.

```
'$INCLUDE: 'qbdec1.bas'  
CLS  
,  
' Open Device  
,  
CALL IBFIND("GPIB0", BD%)  
CALL IBFIND("DEV1", AFG%)  
,  
' Set GPIB address  
,  
CALL IBPAD(BD%, 0)  
CALL IBPAD(AFG%, 1)  
,  
' Reset Instrument  
,  
CALL IBWRT(AFG%, "*RST")  
,  
' CH1 settings  
,  
CALL IBWRT(AFG%, "FUNCTION SIN")      ' Function is SINE wave.  
CALL IBWRT(AFG%, "FREQUENCY 10E3")  ' Frequency is 10 kHz.  
CALL IBWRT(AFG%, "VOLTAGE:AMPLITUDE 2.00")  ' Amplitude is  
2Vpp.  
CALL IBWRT(AFG%, "VOLTAGE:OFFSET 1.00")  
' Offset is 1 V.  
CALL IBWRT(AFG%, "PHASE:ADJUST 0DEG")  
' Phase is 0 degree.  
  
,  
' CH2 settings  
,  
CALL IBWRT(AFG%, "SOURCE2:FUNCTION SIN")  
' Function is SINE wave.  
CALL IBWRT(AFG%, "SOURCE2:FREQUENCY 10E3")  
' Frequency is 10 kHz.  
CALL IBWRT(AFG%, "SOURCE2:VOLTAGE:AMPLITUDE 1.00")  
' Amplitude is 1 Vpp.  
CALL IBWRT(AFG%, "SOURCE2:VOLTAGE:OFFSET 0.00")  
' Offset is 0 V.  
CALL IBWRT(AFG%, "SOURCE2:PHASE:ADJUST 90DEG")  
' Phase is 90 degree.  
,  
' Save settings and output on  
,  
CALL IBWRT(AFG%, "*SAV 0")  
' Save setup to memory 0.
```

```

CALL IBWRT(AFG%, "*RCL 0")
' Recall setup from memory 0.
,
CALL IBWRT(AFG%, "OUTPUT ON")
' CH1 output on.
CALL IBWRT(AFG%, "OUTPOUT2 ON")
' CH2 output on.

,
' Close GPIB connection
,
CALL IBONL(BD%, 0)
CALL IBONL(AFG%, 1)
,
END

```

**Example 2: Waveform Transfer and Copy**

The second example illustrates a simple waveform transfer from the external controller to the EDIT memory in the Arbitrary Function Generator and a waveform copy from the EDIT memory to the USER1 memory.

```

'$INCLUDE: 'qbdec1.bas'
CLS
,
' Open Device
,
CALL IBFIND("GPIB0", BD%)
CALL IBFIND("DEV1", AFG%)
,
' Set GPIB address
,
CALL IBPAD(BD%, 0)
CALL IBPAD(AFG%, 1)
,
' Reset Instrument
,
CALL IBWRT(AFG%, "*RST")
,
' Create arbitrary block data (Num of points = 2000)
,
' Byte count digit = 4
WAVE$ = "#44000"
' Byte count = 4000
,
FOR I = 1 TO 500

```

```

' Rise time (500 points)
  DATA = I * 8
  HI = INT(DATA / 256)
  LO = DATA - (HI * 256)
  WAVE$ = WAVE$ + CHR$(HI) + CHR$(LO)
NEXT I
,
FOR I = 501 TO 800
' Data Hi (300 points)
  DATA = 4000
  HI = INT(DATA / 256)
  LO = DATA - (HI * 256)
  WAVE$ = WAVE$ + CHR$(HI) + CHR$(LO)
NEXT I
,
FOR I = 801 TO 1000
' Fall time (200 points)
  DATA = (1000 - I) * 20
  HI = INT(DATA / 256)
  LO = DATA - (HI * 256)
  WAVE$ = WAVE$ + CHR$(HI) + CHR$(LO)
NEXT I
,
FOR I = 1001 TO 2000
' Data Lo (1000 points)
  DATA = 0
  HI = INT(DATA / 256)
  LO = DATA - (HI * 256)
  WAVE$ = WAVE$ + CHR$(HI) + CHR$(LO)
NEXT I
,

' Send waveform
' Send arbitrary block data to EDIT memory.
,
CALL IBWRT(AFG%, "TRACE:DATA EMEMORY," + WAVE$)
,
' Copy EDIT data to USER1 memory.
,
CALL IBWRT(AFG%, "TRACE:COPY USER1, EMEM")
,
' Setup CH1 output parameter
,
CALL IBWRT(AFG%, "FUNCTION USER1") ' Function is USER1.
CALL IBWRT(AFG%, "FREQUENCY 8K") ' Frequency is 8 kHz.
CALL IBWRT(AFG%, "OUTPUT ON") ' Output on.

```

```
,  
' Close GPIB connection  
,  
CALL IBONL(BD%, 0)  
CALL IBONL(AFG%, 1)  
,  
END
```

# Status and Events

The AFG310 and AFG320 Arbitrary Function Generators are equipped with an error and event reporting function that conforms to the IEEE-488.2 and SCPI standards. The error and event reporting function is used to check the status of the instrument and identify what type of events have occurred on the instrument.

Figure 5-1 shows an outline of the instruments error and event reporting function.

The error and event reporting function is divided into three blocks by function: Error and Event Status, Operation Status and Questionable Status. The operations processed in these three blocks are summarized in status bytes, which provide the status and event data needed by the user.

## Error and Event Status Block

This block is used to report power on/off, command error, and command execution status.

This block is made up of two registers: the Standard Event Status Register (SESR) and the Event Status Enable Register (ESER). See the Error and Event Status Block shown at the bottom of Figure 5-1.

The SESR is an eight-bit status register. When an error or other type of event occurs on the instrument, the corresponding bit is set. This register cannot be written to by the user. The ESER is an eight-bit enable register that masks the SESR. This mask can be set by the user and can take AND with the SESR to determine whether or not the ESB bit in the Status Byte Register (SBR) should be set. Refer to *Registers* on page 5-3 for the content of the bits in these registers.

### Process Flow

When an event occurs, the SESR bit corresponding to that event is set; the event is stacked in the error and event queue and the OAV bit in the SBR is set. If the bit in the ESER corresponding to the event is also set, the ESB bit in the SBR will be set as well.

If a message has been sent to the Output Queue, the MAV bit in the SBR is set.

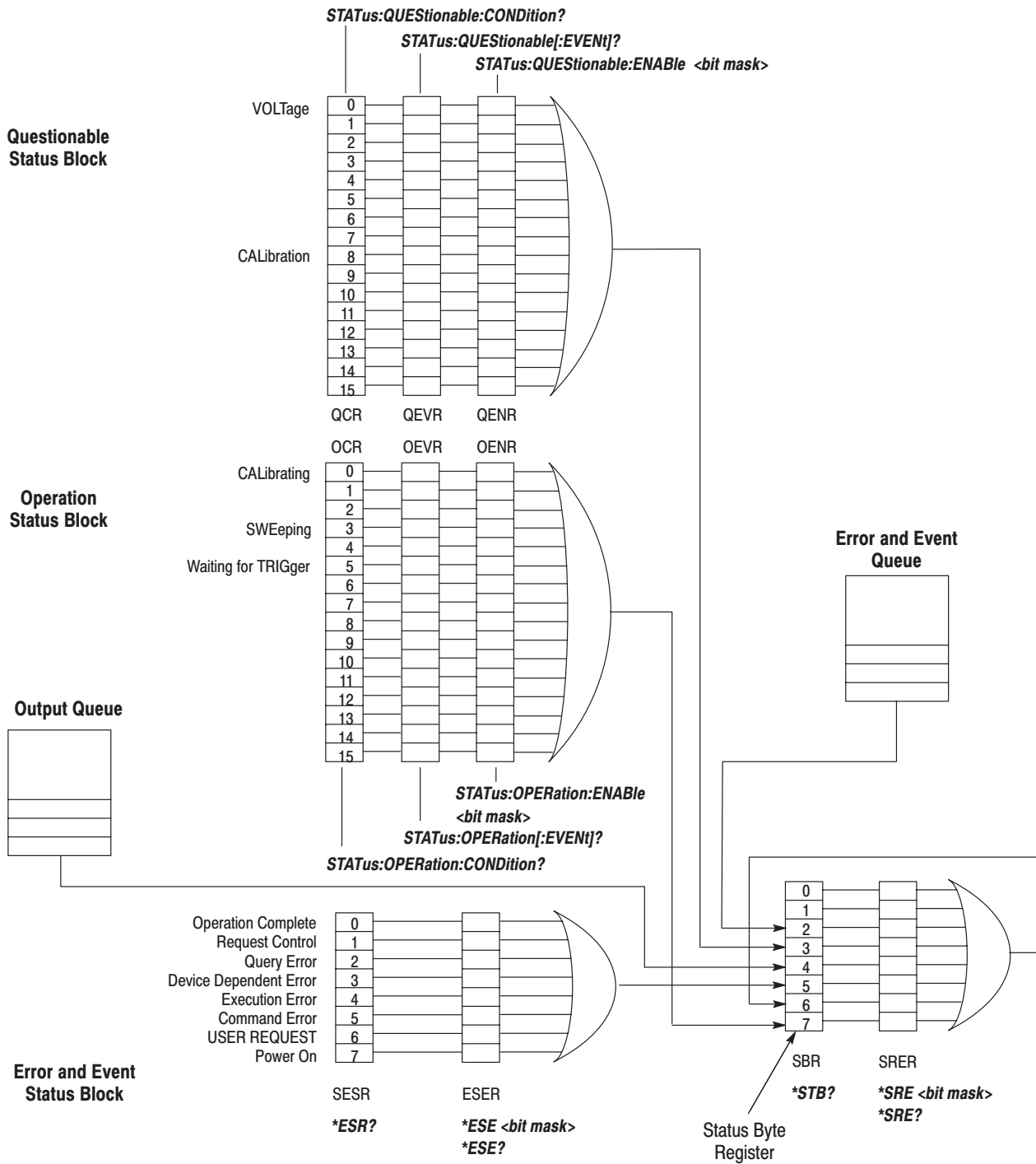

Figure 5-1: Error and Event Handling Process Overview



**Operation Status Block**

This block is used to report on the status of several operations being executed by the Arbitrary Function Generator.

This block is made up of three registers: the Operation Condition Register (OCR), the Operation Event Register (OEVR) and the Operation Enable Register (OENR). See the Error and Event Status Block shown at the bottom of Figure 5-1.

When the instrument achieves a certain status, the corresponding bit is set to the OCR. This register cannot be written to by the user. OCR bits that have changed from false (reset) to true (set) status are set in the OEVR. The function of the OENR is to mask the OEVR. This mask can be set by the user and can take AND with the OEVR to determine whether or not the OSB bit in the Status Byte Register (SBR) should be set. Refer to *Registers* on page 5-3 for the content of the bits in these registers.

**Process Flow.** When the status designated for the OCR changes, a bit in the OCR is set or reset. If a bit has changed from reset to set status, the corresponding bit in the OEVR is set. If the bit corresponding to that status is also set in the OENR, the OSB bit in the SBR is set as well.

**Questionable Status Block**

This block reports on the status of signals and data, such as the accuracy of entered data and signals generated by the instrument. The register configuration and process flow are the same as for the Operation Status Block. QSB is the bit corresponding to Questionable Status Block in the SBR.

## Registers

The registers fall into two functional groups:

- Status registers, which store information about the status of Arbitrary Function Generator.
- Enable registers, which determine whether certain events are reported to the Status Registers and the Event Queue. Enable registers mask the Status Registers. This type of register can be freely set by the user to match the objectives of the user.

**Status Register**

**Status Bytes Register (SBR).** The status byte register (SBR) is made up of 8 bits and is defined as shown in the diagram below. Of these bits, numbers 4, 5 and 6 are defined by IEEE Std. 488.2–1987 and are used to monitor the output queue, SESR (Standard Event Status Register) and service request, respectively.

Bits 7, 3, and 2 are defined by SCPI and monitor the operation status, questionable status and error/event queue.

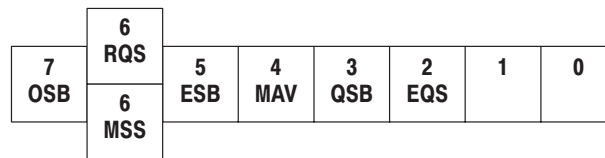

**Table 5-1: SBR Bit Functions**

| Bit     | Function  |
|---------|---|
| 7 (MSB) | <b>OSB</b> (Operation Status Bit): indicates that an operation event has occurred.  |
| 6       | <b>RQS</b> (Request Service) bit: When the instrument is accessed with the GPIB serial poll command, this bit is called the request service (RQS) bit. RQS informs the controller that a service request has occurred (the SRQ line in the GPIB bus has changed to “L”). The RQS bit is cleared when the serial poll completes. |
| 6       | <b>MSS</b> (Master Summary Status) bit: when obtained from *STB? query. This bit indicates that all the SBR bits other than this bit have been set.   |
| 5       | <b>ESB</b> (Event Status Bit): Indicates whether or not a new event occurred after the Standard Event Status Register (SESR) was cleared the previous time or after the readout operation.  |
| 4       | <b>MAV</b> (Message Available) bit: Indicates that messages are stacked in the Output Queue and may be retrieved.   |
| 3       | <b>QSB</b> (Questionable Status Bit): Indicates that a questionable event has occurred.   |
| 2       | <b>EQS</b> (Error and Event Queue Summary): Indicates that events are stacked in the error/event queue.   |
| 1 ~ 0   | Not used. (Must be set to zero for Arbitrary Function Generator operation.)   |

**Standard Event Status Register (SESR).** The Standard Event Status Register (SESR) is made up of eight bits which note the occurrence of eight different types of events as explained below.

|     |     |     |     |     |     |     |     |
|-----|-----|-----|-----|-----|-----|-----|-----|
| 7   | 6   | 5   | 4   | 3   | 2   | 1   | 0   |
| PON | URQ | CME | EXE | DDE | QYE | RQC | OPC |

**Table 5-2: SESR Bit Functions**

| Bit     | Function   |
|---------|--|
| 7 (MSB) | <b>PON</b> (Power On): Indicates that the Arbitrary Function Generator was powered on.   |
| 6       | <b>URQ</b> (User Request). The Arbitrary Function Generator does not use this bit.<br>Indicates an event occurred and because of that event the Arbitrary Function Generator needs attention from the operator.  |
| 5       | <b>CME</b> (Command Error): Indicates that an error occurred while the Arbitrary Function Generator was parsing a command or query. Command error messages are listed in Table 5-7 on page 5-11.   |
| 4       | <b>EXE</b> (Execution Error): Indicates that an error occurred while the Arbitrary Function Generator was executing a command or query. An execution error occurs for either of the following reasons: <ul style="list-style-type: none"> <li>■ A value designated for the argument is out of the range allowed by the Arbitrary Function Generator, is not valid for the command, or is incorrect in some other sense.</li> <li>■ Execution took place improperly under conditions different from those which should have been requested.</li> </ul> Execution error messages are listed in Table 5-8 on page 5-12. |
| 3       | <b>DDE</b> (Device Dependent Error): Indicates that a device-specific error occurred. Device error messages are listed in Table 5-9 on page 5-14.  |
| 2       | <b>QYE</b> (Query Error): Indicates that an error occurred upon attempting to read the output queue. Such an error occurs for one of the following two reasons.: <ul style="list-style-type: none"> <li>■ An attempt was made to retrieve a message from the output queue, even through it is empty or pending.</li> <li>■ Output queue message was cleared while it was being retrieved from the output queue.</li> </ul>   |
| 1       | <b>RQC</b> (Request Control): The Arbitrary Function Generator does not use this bit. Request Control (RQC) is used to show that an instrument has requested to transfer bus control back to the controller. (This is the usage prescribed by the IEEE Std. 488.1.)  |
| 0 (LSB) | <b>OPC</b> (Operation Complete): Indicates that the operation is complete. This bit is set when all pending operations complete following a *OPC command.  |

**Operation Event Register (OEVR).** In this instrument, this register has the same content as the Operation Condition Register described below.

|    |    |    |    |    |    |   |   |   |   |       |   |     |   |   |     |
|----|----|----|----|----|----|---|---|---|---|-------|---|-----|---|---|-----|
| 15 | 14 | 13 | 12 | 11 | 10 | 9 | 8 | 7 | 6 | 5     | 4 | 3   | 2 | 1 | 0   |
|    |    |    |    |    |    |   |   |   |   | WTRIG |   | SWE |   |   | CAL |

**Operation Condition Register (OCR).** The Operation Condition Register (OCR) is made up of sixteen bits, which note the occurrence of three different types of events as explained below.

|    |    |    |    |    |    |   |   |   |   |       |   |     |   |   |     |
|----|----|----|----|----|----|---|---|---|---|-------|---|-----|---|---|-----|
| 15 | 14 | 13 | 12 | 11 | 10 | 9 | 8 | 7 | 6 | 5     | 4 | 3   | 2 | 1 | 0   |
|    |    |    |    |    |    |   |   |   |   | WTRIG |   | SWE |   |   | CAL |

**Table 5-3: OCR Bit Functions**

| Bit    | Function   |
|--------|--|
| 15 ~ 6 | Not used. (Must be set to zero for Arbitrary Function Generator operation.)  |
| 5      | <b>WTRIG</b> (Waiting for Trigger) bit: Indicates whether the instrument is waiting for a trigger. This bit is set when CH1 or another channel (in the case of the AFG320) is waiting for a trigger. Bit is reset when the waiting-for-trigger status is canceled. |
| 4      | Not used. (Must be set to zero for Arbitrary Function Generator operation.)  |
| 3      | <b>SWE</b> (Sweep) bit: Indicates whether the instrument is executing a frequency sweep. This bit is set when a frequency sweep is being executed on CH1 or another channel (in the case of the AFG320). Bit is reset when execution stops.                        |
| 2 ~ 1  | Not used. (Must be set to zero for Arbitrary Function Generator operation.)  |
| 0      | <b>CAL</b> (Calibration) bit: Indicates whether the instrument is being calibrated. This bit is set when calibration is in progress and is reset when calibration ends.  |

**Questionable Event Register (QEVR).** In this instrument, this register has the same content as the Questionable Condition Register described below.

|    |    |    |    |    |    |   |     |   |   |   |   |   |   |   |      |
|----|----|----|----|----|----|---|-----|---|---|---|---|---|---|---|------|
| 15 | 14 | 13 | 12 | 11 | 10 | 9 | 8   | 7 | 6 | 5 | 4 | 3 | 2 | 1 | 0    |
|    |    |    |    |    |    |   | CAL |   |   |   |   |   |   |   | VOLT |

**Questionable Condition Register (QCR).** The Questionable Condition Register (QCR) is made up of sixteen bits which note the occurrence of only one type of event as explained below.

|    |    |    |    |    |    |   |          |   |   |   |   |   |   |   |           |
|----|----|----|----|----|----|---|----------|---|---|---|---|---|---|---|-----------|
| 15 | 14 | 13 | 12 | 11 | 10 | 9 | 8<br>CAL | 7 | 6 | 5 | 4 | 3 | 2 | 1 | 0<br>VOLT |
|----|----|----|----|----|----|---|----------|---|---|---|---|---|---|---|-----------|

**Table 5-4: QCR Bit Functions**

| Bit    | Function  |
|--------|---|
| 15 ~ 9 | Not used. (Must be set to zero for Arbitrary Function Generator operation.)   |
| 8      | <b>CAL</b> (Calibration) bit: Indicates whether the calibration is completed without error. This bit is set when errors are detected after calibration.                                       |
| 7 ~ 1  | Not used. (Must be set to zero for Arbitrary Function Generator operation.)   |
| 0      | <b>VOLT</b> (VOLTage) bit: indicates that the amplitude or offset value currently set is not reliable. This bit is set when amplitude or offset is set after calibration errors are detected. |

## Enable Register

The bits in the enable register correspond to the bits in the event register being controlled. By setting or resetting the bits in the enable register, the operator can determine whether an event that has occurred should be recorded to the status register. In other words, these bits mask the status register.

**Event Status Enable Register (ESER).** The Event Status Enable Register (ESER) is made up of bits that are defined exactly the same as bits 0 through 7 in the SESR. This register is used for the operator to define whether the ESB bit in the SBR is set when an event occurs and the corresponding SESR bit is set.

|          |          |          |          |          |          |          |          |
|----------|----------|----------|----------|----------|----------|----------|----------|
| 7<br>PON | 6<br>URQ | 5<br>CME | 4<br>EXE | 3<br>DDE | 2<br>QYE | 1<br>RQC | 0<br>OPC |
|----------|----------|----------|----------|----------|----------|----------|----------|

When the SESR bit is set, the ESER bit corresponding to the event should be set to cause the ESB bit in the SBR to be set. Conversely, the ESER bit corresponding to the event should be reset to cause the ESB bit in the SBR not to be set. For example, when all bits in the ESER have been reset to 0, the ESB bit in the SBR will not be set, even if some sort of error should occur.

Use the \*ESE command to set the bits in the ESER. Use the \*ESE? query to read it.

**Service Request Enable Register (SRER).** The Service Request Enable Register (SRER) controls bit 6 in the Status Byte Register (SBR). When this register is set, if the corresponding bit in the SBR is set, the RQS bit in the SBR is set and a service request (SRQ) is generated.

In the generation of a service request, the instrument changes the status of the SRQ line in the GPIB bus to “Low” and issues a service request to the controller. The status byte set for RQS is returned in response to the serial polling performed by the controller.

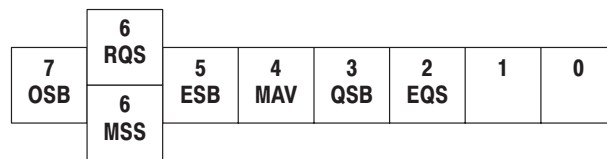

Use the \*SRE command to set the SRER. Use the \*SRE? query to read it. The RQS bit remains set to one until either the Status Byte Register is read with a Serial Poll or the MSS bit changes back to a zero.

**Operation Enable Register (OENR).** The Operation Enable Register (OENR) is made up of bits that are defined exactly the same as bits 0 through 15 in the OEVR. This register is used for the operator to define whether the OSB bit in the SBR is set when an event occurs and the corresponding OEVR bit is set.

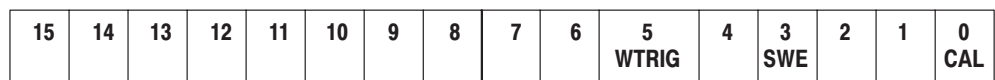

Use the STATUS:OPERation:ENABLE command to set the bits in the OENR. Use the STATUS:OPERation:ENABLE? query to read it.

**Questionable Enable Register (QENR).** The Questionable Enable Register (QENR) is made up of bits that are defined exactly the same as bits 0 through 15 in the OEVR. This register is used for the operator to define whether the QSB bit in the SBR is set when an event occurs and the corresponding QEVR bit is set.

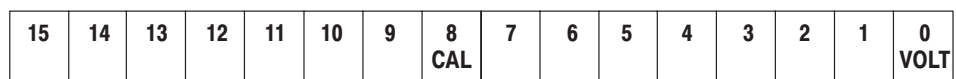

Use the STATUS:QUESTionable:ENABLE command to set the bits in the OENR. Use the STATUS:QUESTionable:ENABLE? query to read it.

**Queue** The status and event reporting system contains two queues, the Output Queue and the Event Queue.

**Output Queue.** The Output Queue is a FIFO (First In First Out) queue that holds response messages until they are requested. When a message is put in the queue, the MAV bit in the Status Byte Register (SBR) is set.

The Output Queue empties each time the Arbitrary Function Generator receives a new command or query. Therefore the controller must read the output queue before it sends the next command or query command or it will lose responses to earlier queries. If a command or query command is given without taking it out, an error results and the Output Queue is emptied.

**Error and Event Queue.** The Event Queue is a FIFO queue which can hold up to 64 Arbitrary Function Generator events. When the number of events exceeds 64, the 64th event is replaced by the event code –350, “Queue overflow”.

Events are retrieved by achieving synchronicity with the \*ESR? query and using the SYSTem:ERRor? or STATus:QUEue[:NEXT]? query as described below.

First, the \*ESR? query is issued to read the contents of the SESR (and the contents of the SESR are cleared as soon as they have been read). If a bit has been set in the SESR, it indicates that events have been stacked in the Error and Event Queue. The event codes can be retrieved using the SYSTem:ERRor? or STATus:QUEue[:NEXT]? queries.

\*ESR?  
SYSTem:ERRor? (or STATus:QUEue[:NEXT]?)

If an event is retrieved from the Error and Event Queue without using the \*ESR? query, the SESR bit will remain set even when the event has disappeared from the Error and Event Queue. Conversely, even if the SYSTem:ERRor? or STATus:QUEue[:NEXT]? query is used to retrieve all events from the Error and Event Queue and the \*ESR? query has not been used to clear the SESR, a bit will be set in the SESR even though there are no events stacked in the Error and Event Queue.

If a new event occurs before existing events are retrieved, the bit corresponding to the SESR event will be set and the event will be stacked to the Error and Event Queue.

## Event Codes and Messages

Tables 5–5 through 5–13 list the status and event messages used in the GPIB status and event reporting system.

### Dequeuing Event Code and Message

Most messages returned have both an event message, followed by a semicolon (;), and a second message which contains more detailed information. These secondary messages are not listed in this manual.

The `SYSTEM:ERRor?`, and `STATUS:QUEue[:NEXT]?` queries return both the event code and event message in the following format:

`<event code>, “<event message ; secondary message>”`

When using these query commands, use the `*ESR?` query to make the events available for dequeuing.

### Codes and Messages

Table 5–5 lists the definition of event codes. When an error has occurred, it is possible to find out what class of error has occurred by simply checking the code range. See Tables 5–6 through 5–13 for more information on events used by the Arbitrary Function Generator; events are organized by class in these tables.

**Table 5–5: Definition of Event Codes**

| Event Class                     | Event Code Ranges | Descriptions                             |
|---------------------------------|-------------------|--|
| No Events                       | 0                 | No event nor status                      |
| Command Errors                  | -100 ~ -199       | Command syntax errors                    |
| Execution Errors                | -200 ~ -299       | Command execution errors                 |
| Device-Specific Errors          | -300 ~ -399       | Internal device errors (Hardware errors) |
| Query Errors                    | -400 ~ -499       | System event and query errors            |
| Extended Device-Specific Errors | 1 ~ 32767         | Device dependent device errors           |
| Reserved                        | other than above  | (unused)                                 |

Table 5–6 lists the message when the system has no events nor status to report. These have no associated SESR bit.



**Table 5-6: Normal Condition**

| Code | Description                       |
|------|-----------------------------------|
| 0    | No events to report — queue empty |

Table 5-7 lists the error messages generated due to improper command syntax. In this case, check that the command is properly formed and that it follows the syntax.

**Table 5-7: Command Errors (CME Bit:5)**

| Code | Description                 |
|------|-----------------------------|
| -100 | Command error               |
| -101 | Invalid character           |
| -102 | Syntax error                |
| -103 | Invalid separator           |
| -104 | Data type error             |
| -105 | GET not allowed             |
| -108 | Parameter not allowed       |
| -109 | Missing parameter           |
| -110 | Command header error        |
| -111 | Header separator error      |
| -112 | Program mnemonic too long   |
| -113 | Undefined header            |
| -114 | Header suffix out of range  |
| -120 | Numeric data error          |
| -121 | Invalid character in number |
| -123 | Exponent too large          |
| -124 | Too many digits             |
| -128 | Numeric data not allowed    |
| -130 | Suffix error                |
| -131 | Invalid suffix              |
| -134 | Suffix too long             |
| -138 | Suffix not allowed          |
| -140 | Character data error        |
| -141 | Invalid character data      |
| -144 | Character data too long     |
| -148 | Character data not allowed  |
| -150 | String data error           |
| -151 | Invalid string data         |
| -158 | String data not allowed     |
| -160 | Block data error            |
| -161 | Invalid block data          |
| -168 | Block data not allowed      |

**Table 5-7: Command Errors (CME Bit:5) (Cont.)**

| <b>Code</b> | <b>Description</b>               |
|-------------|----------------------------------|
| -170        | Expression error                 |
| -171        | Invalid expression               |
| -178        | Expression data not allowed      |
| -180        | Macro error                      |
| -181        | Invalid outside macro definition |
| -183        | Invalid inside macro definition  |
| -184        | Macro parameter error            |

Table 5-8 lists the execution errors that are detected during execution of a command.

**Table 5-8: Execution Errors (EXE Bit:4)**

| <b>Code</b> | <b>Description</b>       |
|-------------|--------------------------|
| -200        | Execution error          |
| -201        | Invalid while in local   |
| -202        | Settings lost due to RTL |
| -203        | Command protected        |
| -210        | Trigger error            |
| -211        | Trigger ignored          |
| -212        | Arm ignored              |
| -213        | Init ignored             |
| -214        | Trigger deadlock         |
| -215        | Arm deadlock             |
| -220        | Parameter error          |
| -221        | Settings conflict        |
| -222        | Data out of range        |
| -223        | Too much data            |
| -224        | Illegal parameter value  |
| -225        | Out of memory            |
| -226        | Lists not same length    |
| -230        | Data corrupt or stale    |
| -231        | Data questionable        |
| -232        | Invalid format           |
| -233        | Invalid version          |
| -240        | Hardware error           |
| -241        | Hardware missing         |

**Table 5-8 : Execution Errors (EXE Bit:4)**

| <b>Code</b> | <b>Description</b>             |
|-------------|--------------------------------|
| -250        | Mass storage error             |
| -251        | Missing mass storage           |
| -252        | Missing media                  |
| -253        | Corrupt media                  |
| -254        | Media full                     |
| -255        | Directory full                 |
| -256        | File name not found            |
| -257        | File name error                |
| -258        | Media protected                |
| -260        | Expression error               |
| -261        | Math error in expression       |
| -270        | Macro error                    |
| -271        | Macro syntax error             |
| -272        | Macro execution error          |
| -273        | Illegal macro label            |
| -274        | Macro parameter error          |
| -275        | Macro definition too long      |
| -276        | Macro recursion error          |
| -277        | Macro rejuvenation not allowed |
| -278        | Macro header not found         |
| -280        | Program error                  |
| -281        | Cannot create program          |
| -282        | Illegal program name           |
| -283        | Illegal variable name          |
| -284        | Program currently running      |
| -285        | Program syntax error           |
| -286        | Program run time error         |
| -290        | Memory use error               |
| -291        | Out of memory                  |
| -292        | Referenced name does not exist |
| -293        | Referenced name already exists |
| -294        | Incompatible type              |

Table 5–9 lists the internal errors that can occur during operation of the Arbitrary Function Generator. These errors may indicate that the Arbitrary Function Generator needs repair.

**Table 5–9: Internal Device Errors (DDE Bit:3)**

| <b>Code</b> | <b>Description</b>        |
|-------------|---------------------------|
| –300        | Device-specific error     |
| –310        | System error              |
| –311        | Memory error              |
| –312        | PUD memory lost           |
| –313        | Calibration memory lost   |
| –314        | Save/recall memory lost   |
| –315        | Configuration memory lost |
| –330        | Self test failed          |
| –350        | Queue overflow            |

Table 5–10 lists query error messages. These messages are generated when the output queue controller detects a protocol error during the exchange of messages.

**Table 5–10: Query Errors (QYE Bit:2)**

| <b>Code</b> | <b>Description</b>                           |
|-------------|--|
| –400        | Query error                                  |
| –410        | Query INTERRUPTED                            |
| –420        | Query UNTERMINATED                           |
| –430        | Query DEADLOCKED                             |
| –440        | Query UNTERMINATED after indefinite response |

Table 5–11 lists error messages for device-dependent errors detected while a self test command is being executed. Codes are expressed as positive numbers and indicate errors specific to that device.

**Table 5–11: Device Dependent Device Errors (DDE Bit:3)**

| <b>Code</b> | <b>Description</b>    |
|-------------|-----------------------|
| 500         | Self test error       |
| 501         | Flash memory error    |
| 502         | Control memory error  |
| 503         | Waveform memory error |
| 504         | GPIB interface error  |

Table 5–12 lists error messages for device-dependent errors that occur when, as a result of calibration, the calibration constant cannot be set. Codes are expressed as positive numbers and indicate errors specific to that device.

**Table 5–12: Device Dependent Device Errors (DDE Bit:3)**

| <b>Code</b> | <b>Description</b>                  |
|-------------|-------------------------------------|
| 600         | Calibration error                   |
| 601         | Offset calibration error            |
| 602         | Arbitrary gain calibration error    |
| 603         | Sine gain calibration error         |
| 604         | Square gain calibration error       |
| 605         | AM offset calibration error         |
| 606         | Sine flatness calibration error     |
| 607         | Output attenuator calibration error |

Table 5–13 lists error messages for device-dependent errors detected while data was being read from or written to the edit memory or user waveform memory. Codes are expressed as positive numbers and indicate errors specific to that device.

**Table 5–13: Device Dependent Device Errors (DDE Bit:3)**

| <b>Code</b> | <b>Description</b>          |
|-------------|-----------------------------|
| 700         | Trace data error            |
| 701         | User waveform locked        |
| 702         | Trace data byte count error |
| 703         | Too much trace data         |
| 704         | Not enough trace data       |



# Appendix A: Specifications

This section contains the AFG310 and AFG320 Arbitrary Function Generator specifications. All specifications are guaranteed unless labeled “typical.” Typical specifications are provided for your convenience but are not guaranteed.

## Performance Conditions

The performance limits in this specification are valid with these conditions:

- The function generator must have been calibrated/adjusted at an ambient temperature between +20° C and +30° C.
- The function generator must be in an environment with temperature, altitude, humidity, and vibration within the operating limits described in these specifications.
- The function generator must have had a warm-up period of at least 20 minutes.
- The function generator must be operating at an ambient temperature between +10° C and +40° C.

## Electrical Characteristic

**Table A-1: Operating Mode**

| Name       | Description   |
|------------|---|
| Continuous | Generates the waveform continuously.  |
| Triggered  | Output quiescent until triggered by an external, GPIB, or manual trigger, then generates a waveform only one time.  |
| Burst      | Output quiescent until triggered by an external, GPIB, or manual trigger, then generates waveform predefined count. |

**Table A-2: Burst Count**

| Name        | Description   |
|-------------|---|
| Burst Count | 1 to 60 000, or Infinite<br>(Sine or square wave output will stop 100 seconds after the output starts, even if the specified burst count has not been reached.) |
| Resolution  | 1   |

**Table A-3: Waveforms**

| Name                | Description                                    |
|---------------------|--|
| Standard Waveforms  | Sine, Square, Triangle, Ramp, Pulse, Noise, DC |
| Arbitrary Waveforms |  |
| Point Length        | 10 to 16384                                    |
| Vertical Resolution | 12 bits  |
| Number of Waveforms | 4  |

**Table A-4: Frequency**

| Name                          | Description                                     |                  |
|-------------------------------|---|------------------|
| Frequency Range               | Operating Mode:                                 | Frequency Range: |
| Sine, Square                  | Continuous Mode                                 | 10 mHz to 16 MHz |
|                               | Triggered/Burst Mode                            | 10 mHz to 1 MHz  |
| Triangle, Ramp, Pulse         | 10 mHz to 100 kHz                               |                  |
| Noise                         | 5 MHz Bandwidth at 16 MS/s (Megasamples/Second) |                  |
| User Waveforms, Edit Waveform | 10 mHz to 1.6 MHz                               |                  |
| Frequency Resolution          | 10 mHz or 7 digits                              |                  |
| Frequency Accuracy            | $\pm 50$ ppm                                    |                  |

**Table A-5: Amplitude**

| Name       | Description  |
|------------|--|
| Amplitude  |  |
| Range      | 505 mV <sub>p-p</sub> to 10 V <sub>p-p</sub> into 50 $\Omega$ (The absolute peak amplitude plus the offset is limited to +5 V or -5 V) |
|            | 50 mV <sub>p-p</sub> to 500 mV <sub>p-p</sub> into 50 $\Omega$   |
| Resolution | 5 mV   |
| Accuracy   | $\pm (1 \% \text{ of Amplitude} + 5 \text{ mV})$ at 1 kHz with no offset   |
| Impedance  | 50 $\Omega$  |



**Table A-6: Offset**

| Name         | Description   |   |
|--------------|---|---|
| Offset Range | Amplitude Range:<br>505 mV <sub>p-p</sub> to 10 V <sub>p-p</sub><br><br>50 mV <sub>p-p</sub> to 500 mV <sub>p-p</sub> | Offset Range:<br><br>The absolute peak amplitude plus the offset is limited to +5 V or -5 V into 50 Ω<br><br>-0.75 V to +0.75 V into 50 Ω |
| Resolution   | 5 mV  |   |
| Accuracy     | ± (1 % of Offset + 5 mV)  |   |

**Table A-7: Phase**

| Name   | Description  |  |
|--|--|--|
| Phase Range<br>Sine, Square  | Operating Mode and Output Frequency:<br>Continuous Mode<br>Triggered/Burst, $f \leq 100$ kHz<br>Triggered/Burst,<br>100 kHz < $f \leq 1$ MHz | Phase Range:<br>± 360°<br>± 360°<br>0° Fixed |
| Triangle, Ramp, Pulse,<br>User Waveforms, Edit Waveform                                    | Continuous Mode<br>Triggered/Burst   | 0° Fixed<br>± 360°                           |
| Phase Resolution<br>Sine, Square<br>Triangle, Ramp, Pulse<br>User Waveforms, Edit Waveform | Restriction:<br>No restrictions<br>Output_Frequency ≤ 2 kHz<br>Waveform_Length ≥ 360 points  | Phase Resolution:<br>1°<br>1°<br>1°          |
| Offset Phase Accuracy, typical<br>(Sine Wave, Amplitude 1 V,<br>No Offset at Phase 0°)     | Frequency Range:<br>Less than 10 kHz<br>10 kHz to 100 kHz  | Accuracy:<br>± 0.1°<br>± 0.2°                |

**Table A-8: Main Output**

| Name   | Description  |                    |                      |                   |            |                   |              |                  |            |                 |         |
|--|--|--------------------|----------------------|-------------------|------------|-------------------|--------------|------------------|------------|-----------------|---------|
| Sine Wave  |  |                    |                      |                   |            |                   |              |                  |            |                 |         |
| Flatness, relative to 1 kHz at Amplitude $1.2 V_{p-p}$                 | <table border="1"> <thead> <tr> <th>Frequency Setting:</th> <th>Flatness Range:</th> </tr> </thead> <tbody> <tr> <td>Less than 100 kHz</td> <td><math>\pm 1 \%</math></td> </tr> <tr> <td>100 kHz to 1 MHz</td> <td><math>\pm 1.5 \%</math></td> </tr> <tr> <td>1 MHz to 16 MHz</td> <td><math>\pm 3 \%</math></td> </tr> </tbody> </table>            | Frequency Setting: | Flatness Range:      | Less than 100 kHz | $\pm 1 \%$ | 100 kHz to 1 MHz  | $\pm 1.5 \%$ | 1 MHz to 16 MHz  | $\pm 3 \%$ |                 |         |
| Frequency Setting:   | Flatness Range:  |                    |                      |                   |            |                   |              |                  |            |                 |         |
| Less than 100 kHz  | $\pm 1 \%$   |                    |                      |                   |            |                   |              |                  |            |                 |         |
| 100 kHz to 1 MHz   | $\pm 1.5 \%$   |                    |                      |                   |            |                   |              |                  |            |                 |         |
| 1 MHz to 16 MHz  | $\pm 3 \%$   |                    |                      |                   |            |                   |              |                  |            |                 |         |
| Harmonic Distortion, at Amplitude $1 V_{p-p}$                          | <table border="1"> <thead> <tr> <th>Frequency Setting:</th> <th>Harmonic Distortion:</th> </tr> </thead> <tbody> <tr> <td>DC to 20 kHz</td> <td>-65 dBc</td> </tr> <tr> <td>20 kHz to 100 kHz</td> <td>-60 dBc</td> </tr> <tr> <td>100 kHz to 1 MHz</td> <td>-45 dBc</td> </tr> <tr> <td>1 MHz to 16 MHz</td> <td>-35 dBc</td> </tr> </tbody> </table> | Frequency Setting: | Harmonic Distortion: | DC to 20 kHz      | -65 dBc    | 20 kHz to 100 kHz | -60 dBc      | 100 kHz to 1 MHz | -45 dBc    | 1 MHz to 16 MHz | -35 dBc |
| Frequency Setting:   | Harmonic Distortion:   |                    |                      |                   |            |                   |              |                  |            |                 |         |
| DC to 20 kHz   | -65 dBc  |                    |                      |                   |            |                   |              |                  |            |                 |         |
| 20 kHz to 100 kHz  | -60 dBc  |                    |                      |                   |            |                   |              |                  |            |                 |         |
| 100 kHz to 1 MHz   | -45 dBc  |                    |                      |                   |            |                   |              |                  |            |                 |         |
| 1 MHz to 16 MHz  | -35 dBc  |                    |                      |                   |            |                   |              |                  |            |                 |         |
| Total Harmonic Distortion, at Amplitude 1 V and 20 kHz, typical        | 0.05 %   |                    |                      |                   |            |                   |              |                  |            |                 |         |
| Spurious (non harmonic), typical                                       | -55 dBc at 10 MHz  |                    |                      |                   |            |                   |              |                  |            |                 |         |
| Phase Noise, typical   | -90 dBc/Hz, at 10 MHz Carrier Wave with 10 kHz offset  |                    |                      |                   |            |                   |              |                  |            |                 |         |
| Subharmonic, typical   | -50 dBc  |                    |                      |                   |            |                   |              |                  |            |                 |         |
| Cross Talk between Channels, typical                                   | Less than -70 dBc, Only AFG320 (Sine Wave, 1 MHz, Amplitude 1 V, No Offset)  |                    |                      |                   |            |                   |              |                  |            |                 |         |
| Square Wave Pulse Response   |  |                    |                      |                   |            |                   |              |                  |            |                 |         |
| Rise/Fall Time   | Less than 20 ns  |                    |                      |                   |            |                   |              |                  |            |                 |         |
| Overshoot  | Less than 2 %  |                    |                      |                   |            |                   |              |                  |            |                 |         |
| Triangle, Ramp, Pulse, User Waveforms, Edit Waveform Response, typical |  |                    |                      |                   |            |                   |              |                  |            |                 |         |
| Rise/Fall Time   | less than 100 ns   |                    |                      |                   |            |                   |              |                  |            |                 |         |
| Pulse Duty   |  |                    |                      |                   |            |                   |              |                  |            |                 |         |
| Range  | 1 % to 99 %  |                    |                      |                   |            |                   |              |                  |            |                 |         |
| Resolution   | 1 %  |                    |                      |                   |            |                   |              |                  |            |                 |         |
| Jitter, typical  | 2 ns, at 100 kHz   |                    |                      |                   |            |                   |              |                  |            |                 |         |
| DC   |  |                    |                      |                   |            |                   |              |                  |            |                 |         |
| Range  | -5 V to +5 V into 50 $\Omega$  |                    |                      |                   |            |                   |              |                  |            |                 |         |
| Resolution   | 5 mV   |                    |                      |                   |            |                   |              |                  |            |                 |         |
| DC Accuracy  | $\pm (1 \% \text{ of DC volts} + 5 \text{ mV})$  |                    |                      |                   |            |                   |              |                  |            |                 |         |

**Table A-9: Modulation and Sweep**

| Name                          | Description   |
|-------------------------------|---|
| FM Modulation                 |   |
| Modulation Signals            | Sine, Square, Triangle, Ramp, User Waveforms, Edit Waveform |
| Modulating Frequency          | 10 mHz to 10 kHz  |
| Resolution                    | 4 digits  |
| Peak Deviation                | 10 mHz to 8 MHz   |
| Resolution                    | 7 digits  |
| FSK Modulation                |   |
| Modulating Frequency          | 10 mHz to 16 MHz  |
| Key Rate                      | 10 mHz to 50 kHz  |
| Resolution                    | 4 digits  |
| Numbers of Key                | 2   |
| Sweep                         |   |
| Spacing                       | Linear or Log   |
| Direction                     | Up or Down  |
| Start/Stop Frequency          |   |
| Sine, Square                  | 10 mHz to 16 MHz  |
| Triangle, Ramp, Pulse         | 10 mHz to 100 kHz   |
| User Waveforms, Edit Waveform | 10 mHz to 1.6 MHz   |
| Resolution                    | 5 digits  |
| Sweep Time                    | 1 ms to 100 s   |
| Resolution                    | 4 digits  |

**Table A-10: Auxiliary Output**

| Name            | Description              |
|-----------------|--------------------------|
| CH1 SYNC Output |                          |
| Output Level    | Positive TTL Level Pulse |
| Impedance       | 50 $\Omega$              |
| Pulse width     | 25 ns minimum            |

**Table A-11: Auxiliary Input**

| Name   | Description  |  |  |
|--|--|--|--|
| AM Input   |  |  |  |
| Range, typical   | 2 V <sub>p-p</sub> (± 0.2 V Tolerance) for 100 % modulation<br>External signal<br><br>+1 V for 100 % modulation level<br>0 V for 50 % modulation level<br>-1 V for 0 % modulation level  |  |  |
| Impedance  | 10 kΩ  |  |  |
| Maximum Input  | ± 5 V (DC plus peak AC)  |  |  |
| Frequency Response   |  |  |  |
| Ext Signal   | DC to 200 kHz (-3 dB)  |  |  |
| Trigger/Burst Input  |  |  |  |
| Input Level  | TTL Level Compatible   |  |  |
| Pulse Width  | 1 μs minimum   |  |  |
| Impedance  | 10 kΩ  |  |  |
| Maximum Input  | Equal and Less than 5 V  |  |  |
| Trigger to Signal Delay  | Less than 1 μs with sine wave  |  |  |
| Trigger Holdoff  | <table border="1"> <tr> <td>Restriction:<br/><br/>Standard Waves(except phased Square), User Waveforms, Edit Waveform<br/><br/>Square Wave at Phase ≠ 0°</td> <td>Holdoff Time:<br/><br/>5 μs maximum<br/><br/>5 μs maximum + 1.5 cycles</td> </tr> </table> | Restriction:<br><br>Standard Waves(except phased Square), User Waveforms, Edit Waveform<br><br>Square Wave at Phase ≠ 0° | Holdoff Time:<br><br>5 μs maximum<br><br>5 μs maximum + 1.5 cycles |
| Restriction:<br><br>Standard Waves(except phased Square), User Waveforms, Edit Waveform<br><br>Square Wave at Phase ≠ 0° | Holdoff Time:<br><br>5 μs maximum<br><br>5 μs maximum + 1.5 cycles   |  |  |

**Table A-12: Isolation**

| Name      | Description                              |
|-----------|--|
| Isolation | 42 Vpk maximum relative to earth ground. |

**Table A-13: Display**

| Name    | Description                   |
|---------|-------------------------------|
| Display | LCD (20 Characters × 2 Lines) |

**Table A-14: AC Line Power**

| Name                      | Description  |
|---------------------------|--|
| Line Frequency Range      |  |
| 90 V to 250 V AC          | 48.0 Hz to 63.0 Hz   |
| 90 V to 127 V AC          | 48.0 Hz to 440 Hz  |
| Maximum Power Consumption | 70 W   |
| Maximum Current           | 2 A  |
| Line Voltage Range        | Cat II   |
| ⚠<br>115 V                |  |
| High                      | 108 V to 132 V AC  |
| Low                       | 90 V to 110 V AC   |
| 230 V                     |  |
| High                      | 216 V to 250 V AC  |
| Low                       | 180 V to 220 V AC  |
| Fuse Rating               | 1 A Fast, 250 V, UL 198G (3 AG)<br>0.5 A (T), 250 V, IEC 127 |

## Mechanical Characteristic

**Table A-15: Mechanical**

| Name       | Description                        |
|------------|------------------------------------|
| Weight     |                                    |
| Standard   | 5.4 kg (AFG310)<br>5.6 kg (AFG320) |
| Dimensions |                                    |
| Height     | 99 mm (3.9 in), with the feet      |
| Width      | 214 mm (8.4 in)                    |
| Depth      | 411 mm (16.2 in)                   |

## Environmental

**Table A-16: Environmental**

| Name              | Description  |
|-------------------|--|
| Atmospherics      |  |
| Temperature       | Operating: 0° C to +50° C<br>Nonoperating: -20° C to +60° C  |
| Relative humidity | Operating: 0 % to 95 %, at or below +40° C,<br>Operating: 0 % to 75 %, +40° C to +50° C  |
| Altitude          | Operating: Up to 4.5 km (15,000 ft.),<br>(Maximum operating temperature decreases 1° C each 300 m above 1.5 km.)<br>Nonoperating: Up to 15 km (50,000 ft.) |
| Dynamics          |  |
| Random vibration  | Operating: 0.31 g rms, from 5 to 500 Hz, 10 minutes each axis<br>Nonoperating: 2.46 g rms, from 5 to 500 Hz, 10 minutes each axis                          |
| Shock             | Nonoperating: 294 m/s <sup>2</sup> (30 G), Half-sine, 11 ms duration<br>Three shocks per axis in each direction (18 shocks total)                          |

**Table A-17: Installation Requirements**

| Name  | Description   |
|---|---|
| Installation Requirements                   |   |
| Maximum Power Dissipation<br>(Fully Loaded) | 70 W, Maximum line current is 2 A at 90 V line and 50 Hz.                                   |
| Surge Current                               | 12 A (25° C) peak for ≤ 5 line cycles, after product has been turned off for at least 30 s. |
| Cooling Clearance                           | 5 cm (2 in) Top even Rackmounted type<br>5 cm (2 in) Rear                                   |

## Certification and Compliances

The certification and compliances for the AFG310 and AFG320 Arbitrary Function Generator are listed in Table A–18.

**Table A–18: Certifications and compliances**

| Category   | Standards or description   |                         |   |                                    |  |  |   |       |  |
|--|--|-------------------------|---|------------------------------------|--|--|---|-------|--|
| EC Declaration of Conformity – EMC                                   | <p>Meets intent of Directive 89/336/EEC for Electromagnetic Compatibility. Compliance was demonstrated to the following specifications as listed in the Official Journal of the European Communities:</p> <p>EMC Directive 89/336/EEC:</p> <table> <tr> <td>EN 55011</td> <td>Class A Radiated and Conducted Emissions</td> </tr> <tr> <td>EN 50081-1 Emissions:<br/>EN60555-2</td> <td>AC Power Line Harmonic Emissions</td> </tr> <tr> <td>EN 50082-1 Immunity:<br/>IEC801-2<br/>IEC801-3<br/>IEC801-4<br/>IEC801-5</td> <td>Electrostatic Discharge Immunity<br/>RF Electromagnetic Field Immunity<br/>Electrical Fast Transient/Burst Immunity<br/>Power Line Surge Immunity</td> </tr> </table>                     | EN 55011                | Class A Radiated and Conducted Emissions  | EN 50081-1 Emissions:<br>EN60555-2 | AC Power Line Harmonic Emissions   | EN 50082-1 Immunity:<br>IEC801-2<br>IEC801-3<br>IEC801-4<br>IEC801-5 | Electrostatic Discharge Immunity<br>RF Electromagnetic Field Immunity<br>Electrical Fast Transient/Burst Immunity<br>Power Line Surge Immunity            |       |  |
| EN 55011   | Class A Radiated and Conducted Emissions   |                         |   |                                    |  |  |   |       |  |
| EN 50081-1 Emissions:<br>EN60555-2                                   | AC Power Line Harmonic Emissions   |                         |   |                                    |  |  |   |       |  |
| EN 50082-1 Immunity:<br>IEC801-2<br>IEC801-3<br>IEC801-4<br>IEC801-5 | Electrostatic Discharge Immunity<br>RF Electromagnetic Field Immunity<br>Electrical Fast Transient/Burst Immunity<br>Power Line Surge Immunity   |                         |   |                                    |  |  |   |       |  |
| Australian/New Zealand declaration of Conformity - EMC               | <p>Complies with EMC provision of Radio–communications Act per the following standard:</p> <table> <tr> <td>AS/NZS 2064.1/2</td> <td>Industrial, Scientific, and Medical Equipment: 1992</td> </tr> </table>   | AS/NZS 2064.1/2         | Industrial, Scientific, and Medical Equipment: 1992                                       |                                    |  |  |   |       |  |
| AS/NZS 2064.1/2  | Industrial, Scientific, and Medical Equipment: 1992  |                         |   |                                    |  |  |   |       |  |
| EC Declaration of Conformity – Low Voltage                           | <p>Compliance was demonstrated to the following specification as listed in the Official Journal of the European Communities:</p> <p>Low Voltage Directive 73/23/EEC, amended by 93/68/EEC</p> <table> <tr> <td>EN 61010-1/A2:1995</td> <td>Safety requirements for electrical equipment for measurement, control and laboratory use.</td> </tr> </table>   | EN 61010-1/A2:1995      | Safety requirements for electrical equipment for measurement, control and laboratory use. |                                    |  |  |   |       |  |
| EN 61010-1/A2:1995   | Safety requirements for electrical equipment for measurement, control and laboratory use.  |                         |   |                                    |  |  |   |       |  |
| Approvals  | <p>Complies with the following safety standards:</p> <table> <tr> <td>UL3111–1, First Edition</td> <td>Standard for electrical measuring and test equipment.</td> </tr> <tr> <td>CAN/CSA C22.2 No.1010.1-92</td> <td>Safety requirements for electrical equipment for measurement, control and laboratory use.</td> </tr> </table>   | UL3111–1, First Edition | Standard for electrical measuring and test equipment.                                     | CAN/CSA C22.2 No.1010.1-92         | Safety requirements for electrical equipment for measurement, control and laboratory use.                                      |  |   |       |  |
| UL3111–1, First Edition  | Standard for electrical measuring and test equipment.  |                         |   |                                    |  |  |   |       |  |
| CAN/CSA C22.2 No.1010.1-92   | Safety requirements for electrical equipment for measurement, control and laboratory use.  |                         |   |                                    |  |  |   |       |  |
| Installation Category Description                                    | <p>Terminals on this product may have different installation (over–voltage) category designations. The installation categories are:</p> <table> <tr> <td>Category</td> <td>Examples of products in this category</td> </tr> <tr> <td>CAT III</td> <td>Distribution-level mains (usually permanently connected). Equipment at this level is typically in a fixed industrial location.</td> </tr> <tr> <td>CAT II</td> <td>Local-level mains (wall sockets). Equipment at this level includes appliances, portable tools, and similar products. Equipment is usually cord-connected.</td> </tr> <tr> <td>CAT I</td> <td>Secondary (signal level) or battery operated circuits of electronic equipment.</td> </tr> </table> | Category                | Examples of products in this category   | CAT III                            | Distribution-level mains (usually permanently connected). Equipment at this level is typically in a fixed industrial location. | CAT II   | Local-level mains (wall sockets). Equipment at this level includes appliances, portable tools, and similar products. Equipment is usually cord-connected. | CAT I | Secondary (signal level) or battery operated circuits of electronic equipment. |
| Category   | Examples of products in this category  |                         |   |                                    |  |  |   |       |  |
| CAT III  | Distribution-level mains (usually permanently connected). Equipment at this level is typically in a fixed industrial location.   |                         |   |                                    |  |  |   |       |  |
| CAT II   | Local-level mains (wall sockets). Equipment at this level includes appliances, portable tools, and similar products. Equipment is usually cord-connected.  |                         |   |                                    |  |  |   |       |  |
| CAT I  | Secondary (signal level) or battery operated circuits of electronic equipment.   |                         |   |                                    |  |  |   |       |  |

**Table A-18: Certifications and compliances (cont.)**

| Category               | Standards or description  |
|------------------------|---|
| Pollution Degree       | <p>A measure of the contaminates that could occur in the environment around and within a product. Typically the internal environment inside a product is considered to be the same as the external. Products should be used only in the environment for which they are rated.</p> <p>Pollution Degree 2                      Normally only dry, nonconductive pollution occurs. Occasionally a temporary conductivity that is caused by condensation must be expected. This location is a typical office/home environment. Temporary condensation occurs only when the product is out of service.</p> |
| Conditions of Approval | <p>Safety Certifications/Compliances are made for the following conditions:</p> <p>Temperature (operation): +5 °C to +40 °C</p> <p>Altitude (maximum operation): 2000 meters</p>  |
| IEC Characteristics    | <p>Equipment type:</p> <p>Test and Measuring<br/>                     Installation Category II (as defined in IEC 61010-1, Annex J)<br/>                     Pollution Degree 2 (as defined in IEC 61010-1)<br/>                     Safety Class I (as defined in IEC 61010-1, Annex H)</p>  |



# Appendix B: Self Test and Calibration Procedure

Two types of performance tests can be performed on this product. You may not need to perform all of these procedures, depending on what you want to accomplish.

- To quickly confirm that the the AFG310 or AFG320 Arbitrary Function Generator is operating properly, complete the *Self Test* under *Brief Procedures* that begins on page B–2.
- To further check functionality and proper calibration, first complete the Self Test; then complete the brief procedures under *Calibration Test* that begins on page B–3.

**Advantages:** These procedures are quick to do, require no external equipment or signal sources, and perform extensive functional and accuracy testing to provide high confidence that the Arbitrary Function Generator will perform properly. They can be used as a quick check before making a series of important measurements.

If you are not familiar with operating this Arbitrary Function Generator, read the *Getting Started* and *Operating Basics* sections in this manual. These sections contain instructions that will familiarize you with the use of the front panel controls and the menu system.

## Conventions

Throughout these procedures the following conventions apply:

- Each test procedure uses the following general format:

Title of Test

Equipment Required

Prerequisites

Procedure

- Each procedure consists of as many steps and substeps as required to do the test. Steps and substeps are sequenced. Refer to *Conventions* on page xi for further information.

## Brief Procedures

Follow the *Self Test* and *Calibration Test* procedures below to verify that the AFG310 or AFG320 is operating properly.

**Self Test** This procedure uses internal routines to verify that the Arbitrary Function Generator is operating properly. No test equipment or hookups are required.

**Table B-1: Self Test Requirements**

| Equipment Required | Prerequisites  |
|--------------------|--|
| None               | Power on the Arbitrary Function Generator and allow a 20 minute warm up before doing this procedure. |

Do the following steps to verify passing of internal self test.

1. Select the SELF TEST item in the SYSTEM menu. Do the following procedure:

SHIFT → PHASE → < button until SELF TEST is displayed → ENTER

2. Press ENTER button to execute self test.  
The message “\*\*\*TESTING\*\*\*” is displayed in the first line of the LCD during self test.
3. Wait until the test is completed.

When an error is detected during diagnostic execution, the instrument displays the name of that test item.

If multiple errors were detected, the test item names can be viewed using the ∨ and ∧ buttons.

Press the front panel EXIT/CANCEL button to exit from the error display state.

4. Verify passing of the internal self test.  
If the self test completes without finding any problems, the display returns to its state before the self test was executed.
5. Return to regular service. Press EXIT/CANCEL button until the default display is obtained.

**Calibration Test**

This procedure uses internal routines to verify proper calibration. No test equipment or hookups are required.

**Table B-2: Calibration Test Requirements**

| Equipment Required | Prerequisites   |
|--------------------|---|
| None               | Power on the Arbitrary Function Generator and allow a 20 minute warm up before doing this procedure. An ambient temperature is between +20° C and +30° C. |

Do the following steps to verify passing of internal calibration.

1. Select the **CALIBRATION** item in the **SYSTEM** menu. Do the following procedure:

**SHIFT** → **PHASE** → < button until **CALIBRATION** is displayed → **ENTER**

2. Press **ENTER** button to execute calibration.

The message “\*\*\***CALIBRATING**\*\*\*” is displayed in the first line of the LCD during calibration.

---

**NOTE.** Do not turn off the power while “\*\*\***CALIBRATING**\*\*\*” is displayed. If the power is turned off while the message is displayed, data stored in internal nonvolatile memory may be lost.

---

3. Wait until the calibration is completed.

When an error is detected during calibration execution, the instrument displays the name of that calibration item.

If multiple errors were detected, the calibration item names can be viewed using the **∨** and **∧** buttons.

Press the front panel **EXIT/CANCEL** button to exit from the error display state.

4. Verify passing of the internal calibration.

If the calibration completes without finding any problems, the display returns to its state before the calibration was executed.

5. Return to regular service. Press **EXIT/CANCEL** button until the default display is obtained.

## Performance Tests

This section contains the following procedures for checking that the Arbitrary Function Generator performs as warranted:

- Output Waveform Checks
- Frequency Accuracy Checks
- Amplitude Accuracy Checks
- DC Voltage Accuracy Checks
- Operating Mode and Phase Checks
- Modulation Checks

### Prerequisites

The tests in this subsection do an extensive check of performance and functionality when the following requirements are met:

- The cabinet covers must be on the Arbitrary Function Generator.
- You must have performed and passed the procedures under Self Tests and Calibration, on page B-2.
- The Arbitrary Function Generator must have been calibrated at an ambient temperature between +20° C and +30° C, must have been operating for a warm-up period of at least 20 minutes, and must be operating at an ambient temperature between 0° C and +50° C.

**Equipment Required** The following equipment is required to check the performance of the Arbitrary Function Generator.

**Table B-3: Test Equipment**

| Item Number and Description                   | Minimum Requirements   | Example                           | Purpose                                |
|---|--|-----------------------------------|--|
| 1 Terminator, 50 $\Omega$                     | Impedance 50 $\Omega$ ; connectors: female BNC input, male BNC output; 50 $\Omega$ +/- 1 $\Omega$ , 2 W, DC to 1 GHz     | Tektronix part number 011-0049-01 | Signal Termination for many Test       |
| 2 Terminator, 50 $\Omega$ , Precision         | Impedance 50 $\Omega$ ; connectors: female BNC input, male BNC output 50 $\Omega$ +/- 0.05 $\Omega$ , 2 W, DC to 100 kHz | Tektronix part number 011-0129-00 | Checking DC Offset and Amplitude       |
| 3 Cable, 50 $\Omega$ Coaxial (three required) | 50 $\Omega$ , 43 in, male to male BNC connectors   | Tektronix part number 012-0057-01 | Signal Interconnection                 |
| 4 Connector, BNC "T"                          | Male BNC to dual female BNC  | Tektronix part number 103-0030-00 | Checking Operating Mode and Phase      |
| 5 N-to-BNC adapter                            | Male N to female BNC   | Tektronix part number 103-0045-00 | Signal Interconnection                 |
| 6 Connector, Dual-Banana                      | Female BNC to dual banana  | Tektronix part number 103-0090-00 | Various Accuracy Tests                 |
| 7 Digital Oscilloscope                        | Over 100 MHz BW  | Tektronix TDS                     | Checking output signals                |
| 8 Frequency Counter/Timer                     | Frequency Range: 1 Hz to 100 MHz<br>Accuracy: $\pm 5 \times 10^{-5}$   | Anritsu MF1603A                   | Checking Frequency Accuracy            |
| 9 Signal Generator                            | Output Range: 0 V to 5 V<br>Frequency: 10 kHz  | Tektronix CFG253                  | Checking Operating Mode and Phase      |
| 10 Digital Multimeter                         | Voltage Range: 0.05 V to 5 V   | Fluke 8842A                       | Checking Amplitude and Offset Accuracy |

**Output Waveform Test**

Check that the seven types of standard waveforms are output. Refer to Table B-4 for test requirements.

**Table B-4: Output Waveform Test Requirements**

| Equipment Required                            | Prerequisites   |
|---|---|
| One 50 Ω terminator<br>(Item 1 on page B-5)   | The Arbitrary Function Generator must meet the prerequisites listed on page B-4 |
| One digital oscilloscope<br>(Item 7 page B-5) |   |
| One coaxial cable (Item 3 on page B-5)        |   |

1. Connect the function generator to a digital oscilloscope.

Use a 50 Ω coaxial cable to connect to the CH1 output of the function generator to a 50 Ω terminator on the CH1 input of the digitizing oscilloscope. Refer to Figure B-1.

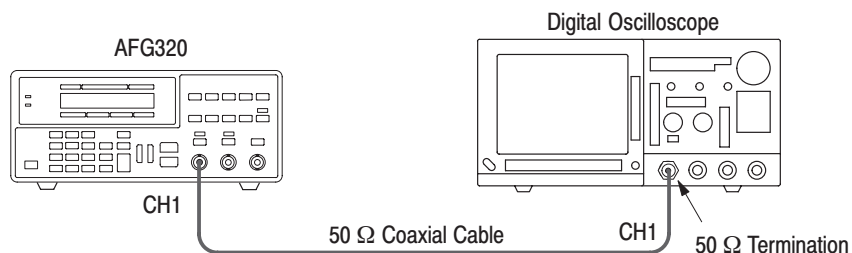

**Figure B-1: Initial Test Hookup**

- Set the oscilloscope controls by selecting the function and settings in Table B-5.

**Table B-5: Oscilloscope settings**

| Function        | Setting        |
|-----------------|----------------|
| CH 1 Vertical   |                |
| Coupling        | DC             |
| Scale           | 0.2V/DIV       |
| Input Impedance | 1 M $\Omega$   |
| Horizontal      |                |
| Sweep           | 10 $\mu$ s/DIV |
| Trigger         |                |
| Source          | CH 1           |
| Coupling        | DC             |
| Slope           | Positive       |
| Level           | +500 mV        |
| Mode            | Auto           |

- Select INITIALIZE in the SYSTEM menu on the function generator. Press the front panel buttons in the following order:  
 SHIFT → PHASE → < button until INITIALIZE is displayed → ENTER → ENTER
- Set the CH1 and CH2 frequencies to 20 kHz then set the controls of the function generator to FUNC for both CH1 and CH2.

Press the front panel buttons in the following order:

FREQ → 2 → 0 → kHz/ms/mV

CH → FREQ → 2 → 0 → kHz/ms/mV

FUNC → CH → FUNC

5. Press the CH1 OUTPUT to set the waveform output to on.

---

**NOTE.** To change the waveform on the function generator, place the cursor on the name of the waveform in the FUNC item and press the ^ button. When the name of the desired waveform appears, press the ENTER button to confirm the selection.

---

6. Change the waveform in the FUNC column on the LCD display.
7. Check the output waveform listed in the Table B-6.

**Table B-6: AFG320 Output Waveform**

| LCD Display in FUNC Column | Output Waveform Description  |
|----------------------------|--|
| SINE                       | 2 Cycles in 10 divisions, Continuous Sine wave                       |
| SQUA                       | 2 Cycles in 10 divisions, Continuous Square wave                     |
| TRIA                       | 2 Cycles in 10 divisions, Continuous Triangle wave                   |
| RAMP                       | 2 Cycles in 10 divisions, Continuous Ramp wave                       |
| PULSE                      | 2 Cycles in 10 divisions, Continuous Pulse wave with 50 % duty ratio |

- a. Change the duty ratio of Pulse wave for 75 %.

SHIFT → FUNC → 7 → 5 → ENTER

|       |  |
|-------|--|
| PULSE | 2 Cycles in 10 divisions, Continuous Pulse wave with 75 % duty ratio |
|-------|--|

- b. Select the DC waveform and then change the DC offset to 0.5 V.

FUNC → ^ → ENTER → OFFSET → 0 → . → 5 → Hz/s/V

|    |           |
|----|-----------|
| DC | +0.5 V DC |
|----|-----------|

- c. Change the DC offset back to 0 V and then select the noise waveform.

0 → Hz/s/V → FUNC → ^ → ENTER

|       |                       |
|-------|-----------------------|
| NOISE | Continuous Noise wave |
|-------|-----------------------|



8. Follow the steps below to check the function generator output waveforms:
  - a. Remove the BNC cable from CH1 connector on the front panel and connect it to the CH2 connector.
  - b. Press the CH2 button to set waveform output to on.
  - c. Press the CH button to change the target channel to CH2.
  - d. Check the CH2 output waveform using the same procedure described in the note on page B-5.

**Frequency Accuracy Test**

Check the frequency accuracy of the output waveform. Refer to Table B-7 for test requirements.

**Table B-7: Frequency Accuracy Test Requirements**

| Equipment Required                      | Prerequisites   |
|---|---|
| One coaxial cable (Item 3 page B-5)     | The Arbitrary Function Generator must meet the prerequisites listed on page B-4 |
| One N-to-BNC adapter (Item 5 page B-5)  |   |
| One frequency counter (Item 8 page B-5) |   |

1. Connect the function generator to the Frequency Counter.

Use a 50 Ω coaxial cable to connect the CH1 output of the function generator to the CH1 input of the Frequency Counter. Refer to Figure B-2.

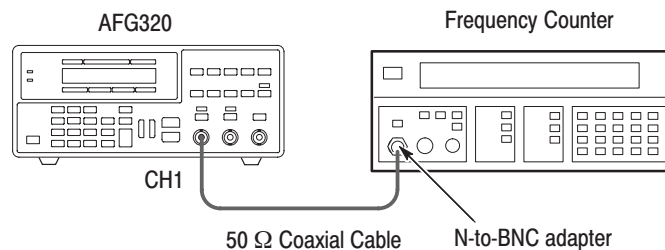

**Figure B-2: Initial Test Hookup**

2. Select INITIALIZE in the SYSTEM menu on the function generator. Press the buttons on the front panel in the following order:  
 SHIFT → PHASE → < button until INITIALIZE is displayed → ENTER → ENTER

3. Set the CH1 and CH2 frequencies to 16 MHz then press the CH button to change the target channel back to Ch1.

Press the buttons on the front panel in the following order:

FUNC → ^ → ENTER

FREQ → 1 → 6 → MHz/μs

CH → FREQ → 1 → 6 → MHz/μs → CH

4. Press the CH1 button to set waveform output to on.
5. Check the frequencies or periods listed in the tables below.
  - a. Use the numeric keys and unit keys to change the frequency of the function generator.

| LCD Display in FREQ Column | Frequency Range                 |
|----------------------------|---------------------------------|
| 16.000 00 (MHz)            | 16.000 800 MHz ~ 15.999 200 MHz |
| 100.000 0 (kHz)            | 100.005 0 kHz ~ 99.995 0 kHz    |

- b. Change the measurement mode of the frequency counter to counter timer and check the period.

| LCD Display in FREQ Column | Frequency Range             |
|----------------------------|-----------------------------|
| 1.000 00 (kHz)             | 1.000 050 ms ~ 0.999 950 ms |
| 1.000 00 (Hz)              | 1.000 050 s ~ 0.999 950 s   |

6. Follow the steps below to check the CH2 frequency accuracy.
  - a. Remove the BNC cable from the CH1 connector on the front panel and connect it to the CH2 connector.
  - b. Press the CH2 button to set waveform output to on.
  - c. Press the CH button on the front panel to change the target channel to CH2.
  - d. Check the CH2 output frequency accuracy using the same procedure described above in Step 5.

**Amplitude Accuracy Test**

Check the amplitude accuracy of the output waveform. Refer to Table B–8 for test requirements.

**Table B–8: Amplitude Accuracy Test Requirements**

| Equipment Required                                 | Prerequisites   |
|--|---|
| One 50 Ω precision terminator (Item 2 on page B–5) | The Arbitrary Function Generator must meet the prerequisites listed on page B–4 |
| One dual-banana connector (Item 6 page B–5)        |   |
| One coaxial cable (Item 3 page B–5)                |   |
| One digital multimeter (Item 10 page B–5)          |   |

1. Use a 50 Ω coaxial cable to connect the CH1 output of the function generator to a 50 Ω precision terminator on the input of the digital multimeter (DMM). Refer to Figure B–3.

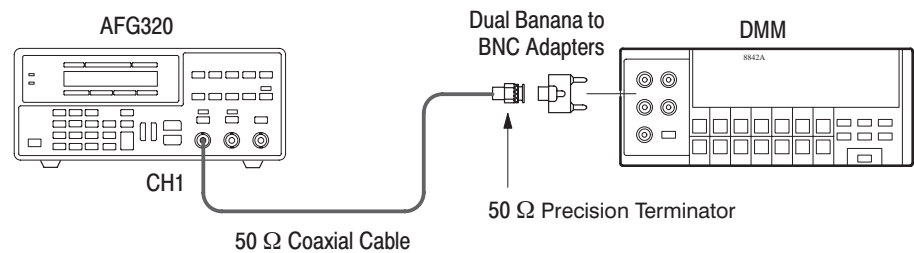

**Figure B–3: Initial Test Hookup**

2. Set the DMM measurement range to AC 20 V.
3. Select INITIALIZE in the SYSTEM menu on the function generator to initialize the system. Press the buttons on the front panel in the following order:

SHIFT → PHASE → < button until INITIALIZE is displayed → ENTER  
 → ENTER

4. Set the CH1 and CH2 frequencies to 1 kHz and amplitude to 10 V<sub>p-p</sub> then press the CH button to change the target channel back to CH1.

FREQ → 1 → kHz/ms/mV

AMPL → 1 → 0 → Hz/s/V

CH → FREQ → 1 → kHz/ms/mV

AMPL → 1 → 0 → Hz/s/V → CH

5. Press the CH1 button to set the waveform output to on.
6. Check that the amplitude for the sine waveform is within the range listed in the following tables.

Use the numeric keys and unit keys to change the amplitude of the function generator.

| LCD Display in AMPL Column | Amplitude Range         |
|----------------------------|-------------------------|
| 10.00 (V <sub>p-p</sub> )  | 3.572 Vrms ~ 3.499 Vrms |
| 7.000 (V <sub>p-p</sub> )  | 2.501 Vrms ~ 2.449 Vrms |

- a. Set the range of the digital multimeter to AC 2 V.

| LCD Display in AMPL Column | Amplitude Range           |
|----------------------------|---------------------------|
| 5.000 (V <sub>p-p</sub> )  | 1.787 Vrms ~ 1.749 Vrms   |
| 3.500(V <sub>p-p</sub> )   | 1.251 Vrms ~ 1.224 Vrms   |
| 2.500(V <sub>p-p</sub> )   | 0.8944 Vrms ~ 0.8733 Vrms |
| 1.750(V <sub>p-p</sub> )   | 0.6266 Vrms ~ 0.6108 Vrms |
| 1.000 (V <sub>p-p</sub> )  | 0.3588 Vrms ~ 0.3483 Vrms |
| 0.700(V <sub>p-p</sub> )   | 0.2517 Vrms ~ 0.2433 Vrms |

- b. Set the range of the digital multimeter to AC 200 mV

| LCD Display in AMPL Column | Amplitude Range             |
|----------------------------|-----------------------------|
| 0.500 (V <sub>p-p</sub> )  | 0.1803 Vrms ~ 0.1733 Vrms   |
| 0.350 (V <sub>p-p</sub> )  | 0.1267 Vrms ~ 0.1208 Vrms   |
| 0.250 (V <sub>p-p</sub> )  | 0.09103 Vrms ~ 0.08574 Vrms |
| 0.125 (V <sub>p-p</sub> )  | 0.04640 Vrms ~ 0.04199 Vrms |
| 0.100 (V <sub>p-p</sub> )  | 0.03747 Vrms ~ 0.03324 Vrms |
| 0.050 (V <sub>p-p</sub> )  | 0.01962 Vrms ~ 0.01574 Vrms |

7. Change the output waveform to SQUA (square). Set the controls of the function generator to AMPL item.

Press the buttons on the front panel in the following order:

FUNC → ^ → ENTER → AMPL

8. Check that the amplitude for the square waveform is within the range listed in following tables.

Use the numeric keys and unit keys to change the amplitude of the function generator.

| LCD Display in AMPL Column | Amplitude Range             |
|----------------------------|-----------------------------|
| 0.050 (V <sub>p-p</sub> )  | 0.02775 Vrms ~ 0.02225 Vrms |
| 0.100 (V <sub>p-p</sub> )  | 0.05300 Vrms ~ 0.04700 Vrms |
| 0.125 (V <sub>p-p</sub> )  | 0.06562 Vrms ~ 0.05938 Vrms |
| 0.250 (V <sub>p-p</sub> )  | 0.1287 Vrms ~ 0.1213 Vrms   |
| 0.350 (V <sub>p-p</sub> )  | 0.1792 Vrms ~ 0.1708 Vrms   |

- a. Set the range of the digital multimeter to AC 2V and check that the square waveform is within the range listed in following table.

| LCD Display in AMPL Column | Amplitude Range           |
|----------------------------|---------------------------|
| 0.500 (V <sub>p-p</sub> )  | 0.2550 Vrms ~ 0.2450 Vrms |
| 0.700 (V <sub>p-p</sub> )  | 0.3560 Vrms ~ 0.3440 Vrms |
| 1.000 (V <sub>p-p</sub> )  | 0.5075 Vrms ~ 0.4925 Vrms |
| 1.750 (V <sub>p-p</sub> )  | 0.8862 Vrms ~ 0.8638 Vrms |
| 2.500 (V <sub>p-p</sub> )  | 1.265 Vrms ~ 1.235 Vrms   |
| 3.500 (V <sub>p-p</sub> )  | 1.770 Vrms ~ 1.730 Vrms   |

- b. Set the range of the digital multimeter to AC 20 V and check that the square waveform is within the range listed in following table.

| LCD Display in AMPL Column | Amplitude Range         |
|----------------------------|-------------------------|
| 5.000 (V <sub>p-p</sub> )  | 2.527 Vrms ~ 2.473 Vrms |
| 7.000 (V <sub>p-p</sub> )  | 3.537 Vrms ~ 3.463 Vrms |
| 10.00 (V <sub>p-p</sub> )  | 5.052 Vrms ~ 4.948 Vrms |

9. Change the output waveform to TRIA (triangle). Set the controls of the function generator to AMPL item.

Press the buttons on the front panel in the following order:

**FUNC → ^ → ENTER → AMPL**

10. Check that the amplitude for the triangle waveform is within the range listed in the tables below.

Use the numeric keys and unit keys to change the amplitude of the function generator.

| LCD Display in AMPL Column | Amplitude Range         |
|----------------------------|-------------------------|
| 10.00 (V <sub>p-p</sub> )  | 2.917 Vrms ~ 2.857 Vrms |
| 7.000 (V <sub>p-p</sub> )  | 2.042 Vrms ~ 2.000 Vrms |

- a. Set the range of the digital multimeter to AC 2 V.

| LCD Display in AMPL Column | Amplitude Range           |
|----------------------------|---------------------------|
| 5.000 (V <sub>p-p</sub> )  | 1.459 Vrms ~ 1.428 Vrms   |
| 3.500 (V <sub>p-p</sub> )  | 1.0219 Vrms ~ 0.9989 Vrms |
| 2.500 (V <sub>p-p</sub> )  | 0.7303 Vrms ~ 0.7131 Vrms |
| 1.750 (V <sub>p-p</sub> )  | 0.5116 Vrms ~ 0.4987 Vrms |
| 1.000 (V <sub>p-p</sub> )  | 0.2930 Vrms ~ 0.2844 Vrms |
| 0.700 (V <sub>p-p</sub> )  | 0.2055 Vrms ~ 0.1987 Vrms |

- b. Set the range of the digital multimeter to AC 200 mV.

| LCD Display in AMPL Column | Amplitude Range             |
|----------------------------|-----------------------------|
| 0.500 (V <sub>p-p</sub> )  | 0.1472 Vrms ~ 0.1415 Vrms   |
| 0.350 (V <sub>p-p</sub> )  | 0.10349 Vrms ~ 0.09859 Vrms |
| 0.250 (V <sub>p-p</sub> )  | 0.07433 Vrms ~ 0.07001 Vrms |
| 0.125 (V <sub>p-p</sub> )  | 0.03788 Vrms ~ 0.03429 Vrms |
| 0.100 (V <sub>p-p</sub> )  | 0.03059 Vrms ~ 0.02714 Vrms |
| 0.050 (V <sub>p-p</sub> )  | 0.01602 Vrms ~ 0.01285 Vrms |

Follow the steps below to check the CH2 amplitude accuracy.

1. Remove the BNC cable from CH1 connector on the front panel and connect it to the CH2 connector.
2. Press the CH2 to set the waveform output to on.
3. Press the CH button to change the target channel to CH2.
4. Check the CH2 output amplitude accuracy using the same procedure described in Steps 6 through 10 on page B-12.

**DC Voltage Accuracy Test**

Check the DC voltage accuracy of the offset output.

Use a 50 Ω coaxial cable to connect the CH1 output of the function generator to a 50 Ω precision terminator on the input of the digital multimeter. Refer to Figure B-3.

**Table B-9: DC Voltage Accuracy Test Requirements**

| Equipment Required                                 | Prerequisites   |
|--|---|
| One 50 Ω precision terminator (Item 2 on page B-5) | The Arbitrary Function Generator must meet the prerequisites listed on page B-4 |
| One dual-banana connector (Item 6 page B-5)        |   |
| One coaxial cable (Item 3 page B-5)                |   |
| One digital multimeter (Item 10 page B-5)          |   |

1. Set the DMM measurement range to DC 20 V.
2. Select INITIALIZE in the SYSTEM menu on the function generator to initialize the system. Press the buttons on the front panel in the following order:
  - SHIFT → PHASE → < button until INITIALIZE is displayed → ENTER → ENTER
3. Set the CH1 and CH2 FUNC waveforms to DC and offset to +5 V then press the CH button to change the target channel back to CH1.
  - FUNC → ^ button until DC is displayed → ENTER
  - OFFSET → 5 → Hz/s/V
  - CH → FUNC → ^ button until DC is displayed → ENTER
  - OFFSET → 5 → Hz/s/V → CH
4. Press the CH1 button to set waveform output to on.



5. Check that the offset voltage for the DC waveform is within the range listed in the table below.
  - a. Use the numeric keys and unit keys to change the offset of the function generator.
  - b. Set the range of the digital multimeter to DC 20 V.

| LCD Display in AMPL Column | Amplitude Range   |
|----------------------------|-------------------|
| 5.000 (V)                  | 5.055 V ~ 4.945 V |

- c. Set the range of the digital multimeter to DC 2 V.

|           |                   |
|-----------|-------------------|
| 1.000 (V) | 1.015 V ~ 0.985 V |
| 0.500 (V) | 0.510 V ~ 0.490 V |

- d. Set the range of the digital multimeter to DC 200 mV.

|            |                     |
|------------|---------------------|
| 0.100 (V)  | 0.106 V ~ 0.094 V   |
| 0.000 (V)  | 0.005 V ~ -0.005 V  |
| -0.100 (V) | -0.106 V ~ -0.094 V |

- e. Set the range of the digital multimeter to DC 2 V.

|            |                     |
|------------|---------------------|
| -0.500 (V) | -0.510 V ~ -0.490 V |
| -1.000 (V) | -1.015 V ~ -0.985 V |

- f. Set the range of the digital multimeter to DC 20 V.

|            |                     |
|------------|---------------------|
| -5.000 (V) | -5.055 V ~ -4.945 V |
|------------|---------------------|

6. Check the CH2 DC voltage accuracy by following the steps below:
  - a. Remove the BNC cable from the CH1 connector on the front panel and connect it to the CH2 connector.
  - b. Press the CH2 button above the BNC connector to set the waveform output to on.
  - c. Press the CH button on the front panel to change the target channel to CH2.
  - d. Check the CH2 output DC voltage accuracy using the same procedure described in step 5 on page B-17.

### **Operating Mode and Phase Test**

Check the phase of the output waveform in the triggered and burst mode.

Refer to Table B-10 and Figure B-4 for test requirements and connections.

Follow the steps below to make the proper connections:

1. Use a 50  $\Omega$  coaxial cable to connect the CH1 output of function generator to a 50  $\Omega$  terminator on the CH1 input of the digital oscilloscope. See Figure B-4.
2. Use a 50  $\Omega$  coaxial cable to connect the output of the signal generator to one side of a BNC T connector.
3. Use a 50  $\Omega$  coaxial cable to connect the CH2 input of the digital oscilloscope to the other side of the BNC T connector.
4. Connect the BNC T connector to the EXT TRIG IN connector of function generator.

Refer to Table B-10 for the accuracy test requirements.

**Table B-10: Operating Mode and Phase Test Requirements**

| Equipment Required                                 | Prerequisites   |
|--|---|
| One 50 $\Omega$ terminator<br>(Item 1 on page B-5) | The Arbitrary Function Generator must meet the prerequisites listed on page B-4 |
| BNC "T" connector (Item 4 page B-5)                |   |
| Three coaxial cables<br>(Item 3 page B-5)          |   |
| One signal generator<br>(Item 9 page B-5)          |   |
| One digital oscilloscope<br>(item 10 page B-5)     |   |

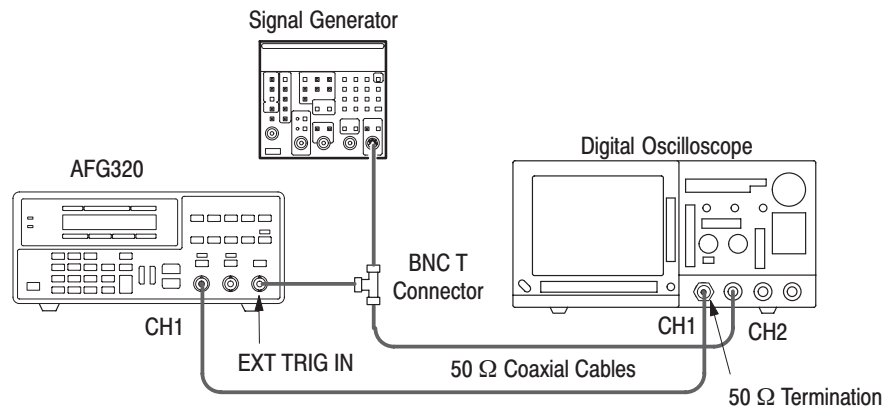

**Figure B-4: Initial Test Hookup**

5. Refer to Table B-11 to set the oscilloscope controls.

**Table B-11: Oscilloscope settings**

| Function        | Setting      |
|-----------------|--------------|
| CH 1 Vertical   |              |
| Coupling        | DC           |
| Scale           | 0.2V/DIV     |
| Input Impedance | 1 M $\Omega$ |
| CH 2 Vertical   |              |
| Coupling        | DC           |

**Table B-11: Oscilloscope settings (Cont.)**

| <b>Function</b> | <b>Setting</b>   |
|-----------------|--|
| Scale           | 0.5 V/DIV  |
| Input Impedance | 1 M $\Omega$ (or external termination if required by source) |
| Horizontal      |  |
| Sweep           | 20 $\mu$ s (adjust for best display)                         |
| Trigger         |  |
| Source          | CH 2   |
| Coupling        | DC   |
| Slope           | Positive   |
| Level           | +500 mV  |
| Mode            | Auto   |

6. Refer to Table B-12 to set the signal generator controls.

**Table B-12: Signal generator settings**

| Function  | Setting                         |
|-----------|---------------------------------|
| Frequency | 10 kHz (square wave)            |
| Amplitude | 0 - 5 V (TTL compatible output) |

7. Select INITIALIZE in the SYSTEM menu on the function generator to initialize the system. Press the buttons on the front panel in the following order:

SHIFT → PHASE → < button until INITIALIZE is displayed → ENTER  
→ ENTER

8. Set the CH1 and CH2 burst count to 3 and set the operating mode to TRIG (triggered). Press the CH button to change the target channel back to CH1.

SHIFT → MODE → 3 → ENTER

MODE → ^ → ENTER

CH → SHIFT → MODE → 3 → ENTER

MODE → ^ → ENTER → CH

9. Press the CH1 button above the BNC connector to set the waveform output to on.
10. Check that the one cycle of the sine wave is output with the phase according to the phase changing from  $+360^\circ$  to  $-360^\circ$  in  $90^\circ$  steps. The phase shift is observed at the starting point of the waveform.

Press the following buttons or keys on the front panel to change the phase by  $-90^\circ$  (relative value).

PHASE → +/- → 9 → 0 → ENTER

The following Figures are examples of waveforms for the different phase settings.

These screen shots were made with a TDS 700 series oscilloscope with CH 1 set to 200 mV/DIV, and using a TTL compatible (0 – 5 V) 10 kHz square wave for the external trigger source.

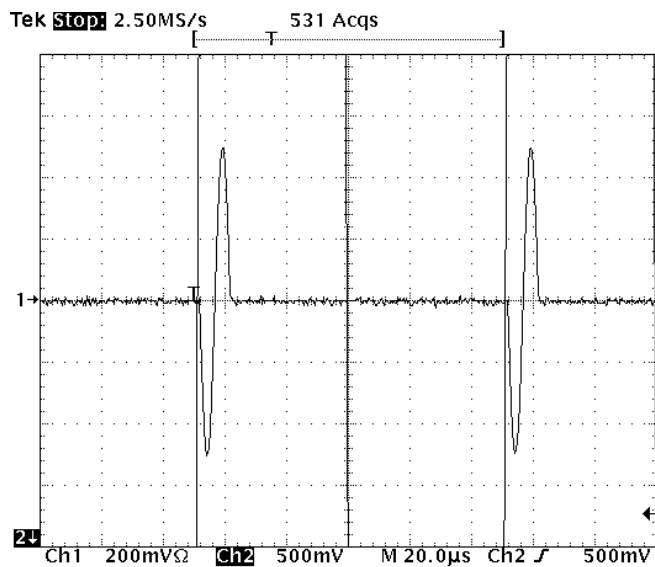

Figure B-5: 1 cycle,  $\pm 180^\circ$  phase

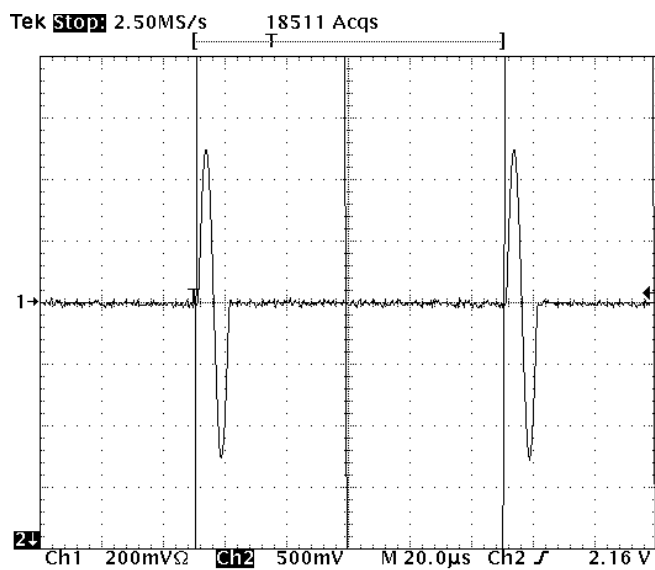

Figure B-6: 1 cycle,  $0^\circ$  phase ( $\pm 360^\circ$ )

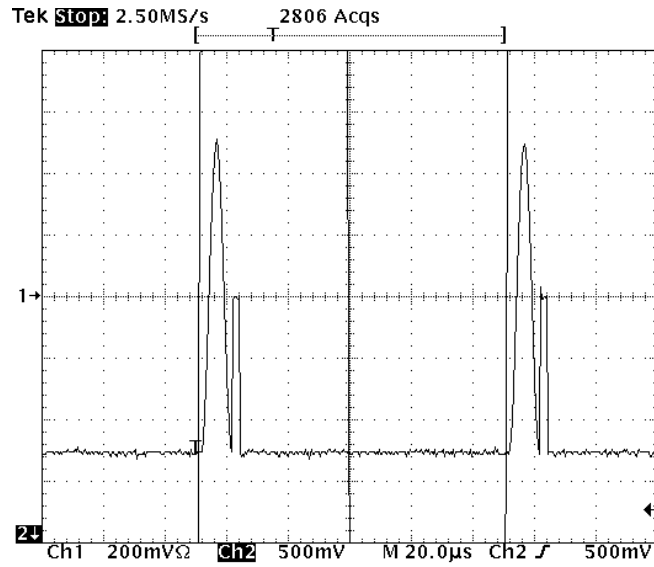

Figure B-7: 1 cycle, +270° phase (-90°)

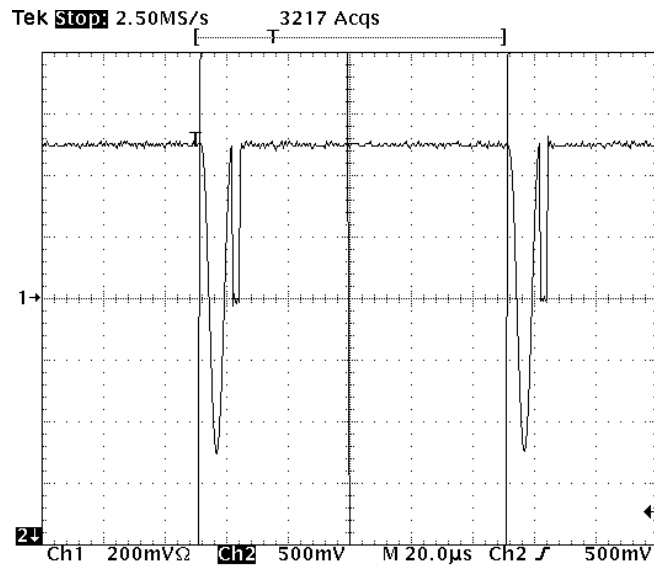

Figure B-8: 1 cycle, +90° phase (-270°)

11. Follow the steps below to change the operating mode to burst.

Press the following buttons on the front panel to change the mode.

MODE → ^ → ENTER

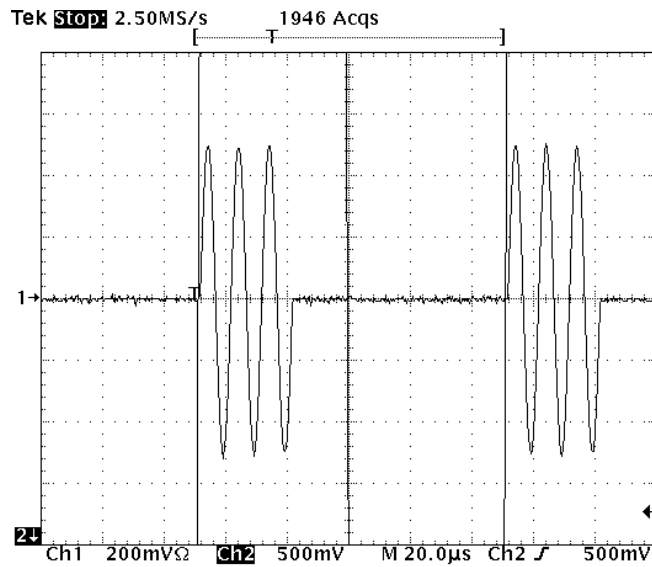

Figure B-9: 3 cycle, 0° phase ( $\pm 360$ )

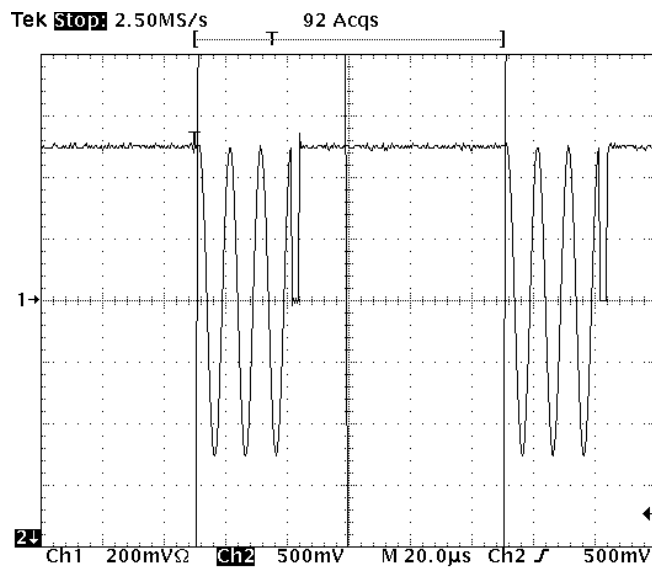

Figure B-10: 3 cycle, +90° phase ( $-270$ )



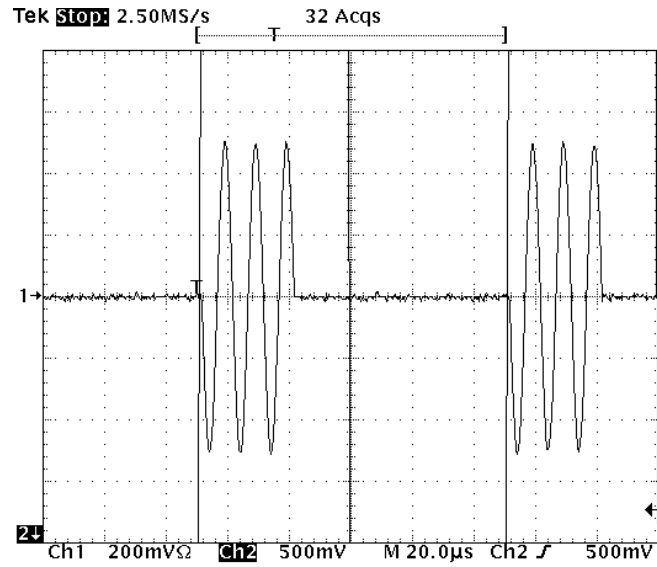

Figure B-11: 3 cycle, +180° phase (-180)

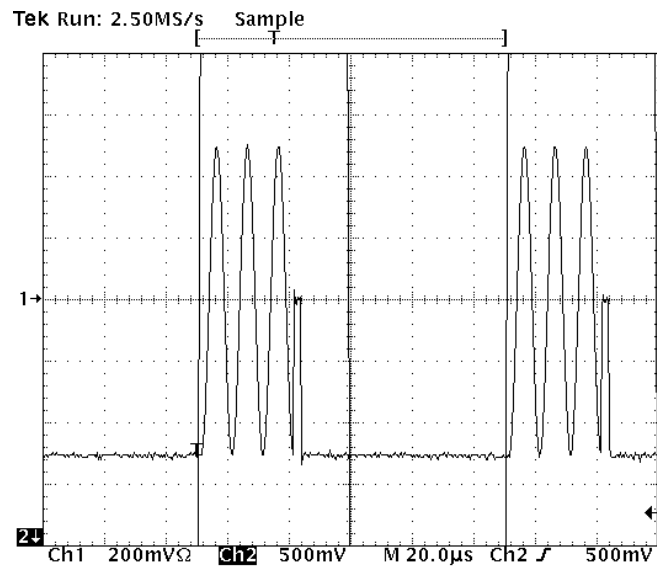

Figure B-12: 3 cycle, +270° phase (-90)

12. Check that the three cycles of the sine wave is output with the phase according to the phase changing from  $+360^\circ$  to  $-360^\circ$  in  $90^\circ$  steps.
13. Follow the steps below to check the phase of the CH2 output.
  - a. Remove the BNC cable from the CH1 connector on the front panel and connect it to the CH2 connector.
  - b. Press the CH2 button above the BNC connector to set the waveform output to on.
  - c. Press the CH button on the front panel to change the target channel to CH2.
  - d. Check the phase of the CH2 output using the same procedure described in Step 10 to 12.

### Modulation Function Test

Check that the sweep, FM modulation, FSK modulation and AM modulation are functioning. Refer to Table B-13.

**Table B-13: Modulation Function Test Requirements**

| Equipment Required                                 | Prerequisites   |
|--|---|
| One 50 $\Omega$ terminator<br>(Item 1 on page B-5) | The Arbitrary Function Generator must meet the prerequisites listed on page B-4 |
| One coaxial cable (Item 3 page B-5)                |   |
| One digital oscilloscope<br>(item 7 page B-5)      |   |

14. Connect the function generator to a digital oscilloscope.

Use a 50  $\Omega$  coaxial cable to connect the CH1 output of the function generator to a 50  $\Omega$  terminator on the CH1 input of the digitizing oscilloscope. Refer to Figure B-13.

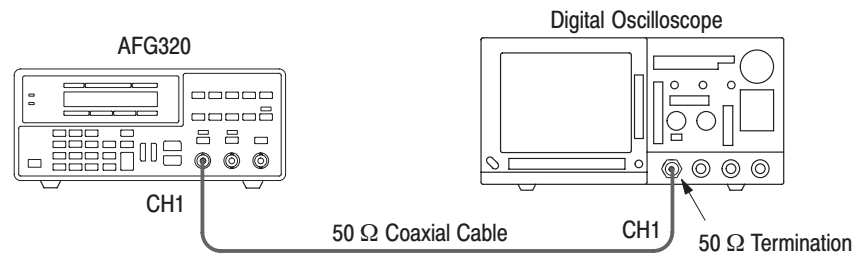

**Figure B-13: Initial Test Hookup**

15. Set the oscilloscope controls as shown in Table B-14.

**Table B-14: Oscilloscope settings**

| Function        | Setting                         |
|-----------------|---------------------------------|
| CH 1 Vertical   |                                 |
| Coupling        | DC                              |
| Scale           | 0.2 V/DIV                       |
| Input Impedance | 1 MΩ                            |
| Horizontal      |                                 |
| Sweep           | 20 μs (adjust for best display) |
| Trigger         |                                 |
| Source          | CH 1                            |
| Coupling        | DC                              |
| Slope           | Positive                        |
| Level           | +100 mV                         |
| Mode            | Auto                            |

16. Select INITIALIZE in the SYSTEM menu on the function generator to initialize the system. Press the buttons on the front panel in the following order:

SHIFT → PHASE → < button until INITIALIZE is displayed → ENTER  
→ ENTER

17. Press the CH1 button above the BNC connector to set the waveform output to on.

18. Press MODUL button on the front panel.

- 19.** Change the modulation type and check the modulation output listed in the table below.

To change the modulation type on the function generator, place the cursor on the name of the modulation in the **MODUL** item and press the **^** button. When the name of the desired modulation appears, press the **ENTER** button to confirm the selection.

| LCD Display in MODUL Column | Modulation Output Description  |
|-----------------------------|--|
| SWP                         | 1 V <sub>p-p</sub> , Sweep output of Sine wave   |
| FM                          | 1 V <sub>p-p</sub> , FM modulation output of Sine wave   |
| FSK                         | 1 V <sub>p-p</sub> , FSK modulation output of Sine wave (frequency alternates between 10 kHz and 100 kHz each 500 ms.) |
| AM                          | 0.5 V <sub>p-p</sub> , Continuous Sine wave  |

- 20.** Follow the steps below to check the CH2 modulation output.
- a.** Remove the BNC cable from CH1 connector on the front panel and connect it to the CH2 connector.
  - b.** Press the **CH2** button above the BNC connector to set waveform output to on.
  - c.** Press the **CH** button on the front panel to change the target channel to CH2.
  - d.** Check the modulation of the CH2 output using the same procedure described in Step 18 to 19. Note that there is no AM modulation function for the CH2 output.

This completes the performance verification procedures. If you require further assistance, contact your nearest Tektronix Service Center.

# Appendix C: Inspection and Cleaning

Inspect and clean the instrument as often as operating conditions require. The collection of dirt can cause instrument overheating and breakdown. Dirt acts as an insulating blanket, preventing efficient heat dissipation. Dirt also provides an electrical conduction path that can cause an instrument failure, especially under high-humidity conditions.



**CAUTION.** *Avoid the use of chemical cleaning agents that might damage the plastics used in this instrument. Use only deionized water when cleaning the menu buttons or front-panel buttons. Use a ethyl alcohol solution as a cleaner and rinse with deionized water.*

## Exterior Inspection

Using Table C-1 as a guide, inspect the outside of the instrument for damage, wear, and missing parts. You should thoroughly check instruments that appear to have been dropped or otherwise abused to verify correct operation and performance. Immediately repair defects that could cause personal injury or lead to further damage to the instrument.

**Table C-1: External Inspection Check List**

| Item                             | Inspect for   | Repair action  |
|----------------------------------|---|--|
| Cabinet, front panel, and cover  | Cracks, scratches, deformations, damaged hardware or gaskets                                | Replace defective module   |
| Front-panel knobs                | Missing, damaged, or loose knobs  | Repair or replace missing or defective knobs                           |
| Connectors                       | Broken shells, cracked insulation, and deformed contacts. Dirt in connectors                | Replace defective modules. Clear or wash out dirt                      |
| Carrying handle and cabinet feet | Correct operation   | Replace defective module   |
| Accessories                      | Missing items or parts of items, bent pins, broken or frayed cables, and damaged connectors | Replace damaged or missing items, frayed cables, and defective modules |

### **Cleaning the Instrument Exterior**



---

**WARNING.** *To avoid injury or death, unplug the power cord from line voltage before cleaning the instrument. Avoid getting moisture inside the instrument during external cleaning. Use only enough liquid to dampen the cloth or applicator.*

---

1. Remove loose dust on the outside of the instrument with a lint-free cloth.
2. Remove remaining dirt with a lint free cloth dampened in a general purpose detergent-and-water solution. Do not use abrasive cleaners.
3. Clean the monitor screen with a lint-free cloth dampened with either ethyl alcohol or, preferably, a gentle, general purpose detergent-and-water solution.

### **Cleaning the Instrument Interior**

Only qualified personnel should access the inside of the AFG310 and AFG320 for inspection and cleaning, refer to the *Maintenace* section in the AFG310 and AFG320 service manual.

# Appendix D: Floating Connections

This appendix covers four floating connection examples you can make between the instrument and other equipment.

Since the common (input and output channel common) of the Arbitrary Function Generator is electrically isolated from the chassis ground (the instrument chassis and ground line of the AC connector), you can make floating connection between the instrument and other equipment.



**WARNING.** To prevent electrical shocks, do not apply voltages in excess of 42 Vpk to any BNC connector ground or to the chassis ground.



**CAUTION.** To prevent damage to the instrument, be sure to all BNC commons are at the same potential.



**CAUTION.** To prevent damage to the instrument, when you make floating connections, pay attention to following examples.

**Example 1.** The maximum rated voltage between the chassis and common is 42 V<sub>p-p</sub> (DC + peak AC).

When the potential voltage between the chassis ground and common goes over 42 V<sub>p-p</sub>, the internal protective circuit will be activated to protect the circuits. However, higher voltage may cause the internal circuits in the instrument to be damaged.

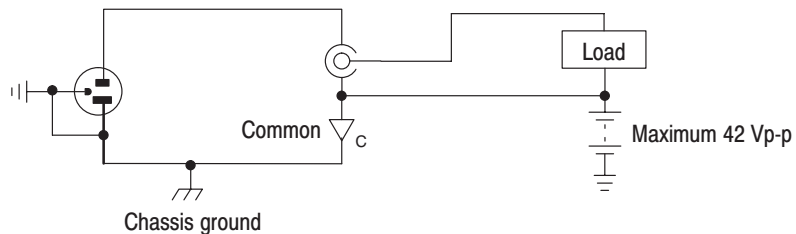

**Example 2.** When the output signal line and the common are shorted, the internal protective circuit is activated to disable the line to the output. The output will automatically be activated when the short is removed. This function is effective for both floating and nonfloating connections.

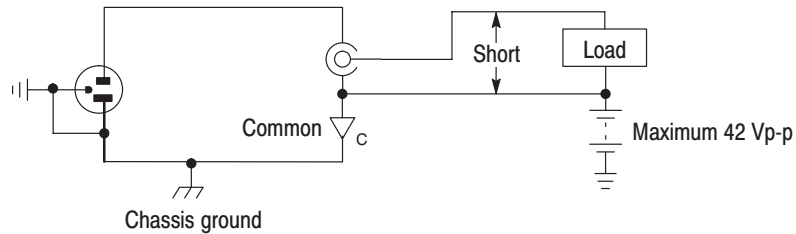

**Example 3.** When a potential voltage exists between the chassis ground and common, a short from output to ground causes the instrument internal fuse to open and the output is stopped. If the fuse opens, you need to contact your local Tektronix Service Center to make arrangements for a service person to replace the fuse.

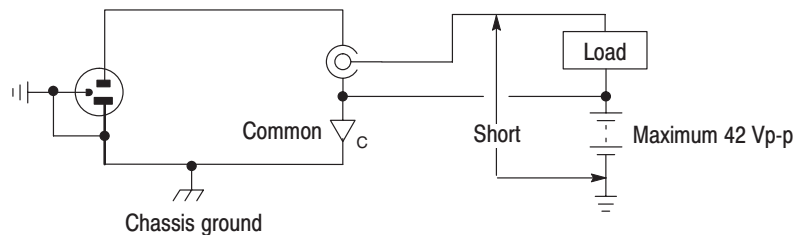

**Example 4.** When a potential voltage exists between the common and chassis ground, shorting between them may lead to excessive current flow and the internal or external circuits may be damaged.

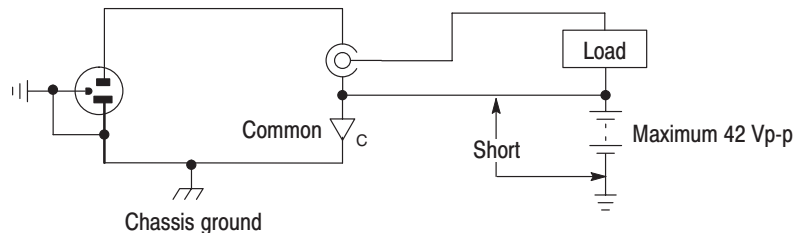



# Appendix E: Miscellaneous

This appendix covers the following items:

- Timing chart of SYNC signal output
- Initial settings
- Secure settings
- Initial Settings for the Command Argument
- Character Charts
- SCPI Conformance
- GPIB Interface Specification

## SYNC Signal Output

SYNC signal output timing information is provided in the following charts.

### Sine and Square Wave

The SYNC pulse goes high when the output waveform exceeds nearly at the zero level (nearly zero cross). The SYNC pulse is delayed from the output waveform about 10 to 15 % of its period.

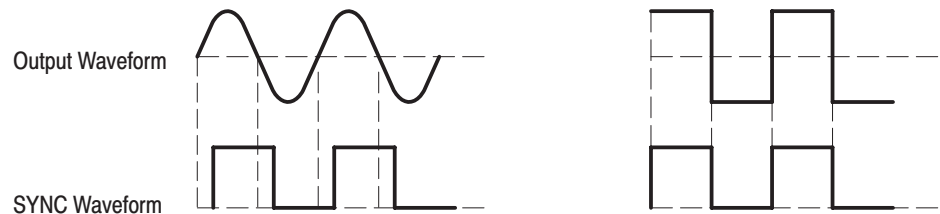

When a waveform is output with the phase set to a value other than 0 degrees in burst or trigger mode, SYNC pulses are also generated on zero crossings as described above according to the output level, including the levels before the trigger event and after waveform output completes.

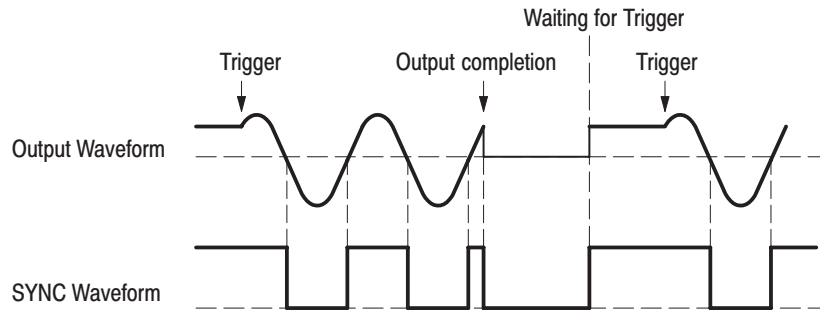

**Triangle, Ramp, Pulse, Noise, User Waveform, and Edit Waveform**

For these waveforms, the SYNC pulse falls immediately prior to the completion of the output of a single cycle of the waveform. The width of the SYNC pulse will vary with the frequency of the output signal.

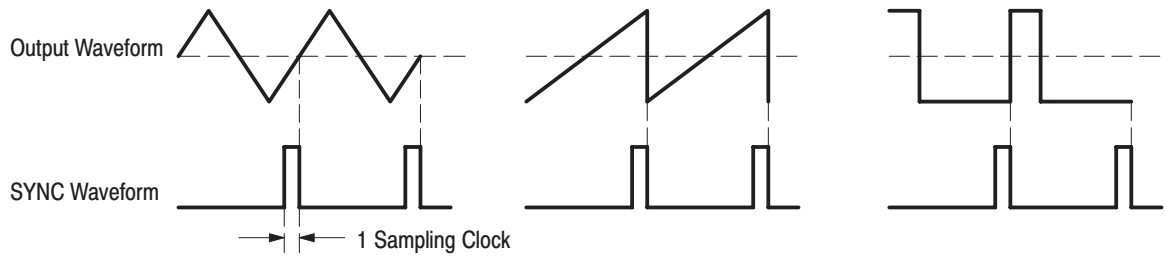

**Modulation and Sweep (except AM)**

The SYNC pulse falls before the frequency switches to the last frequency. The pulse width is about 45 ns.

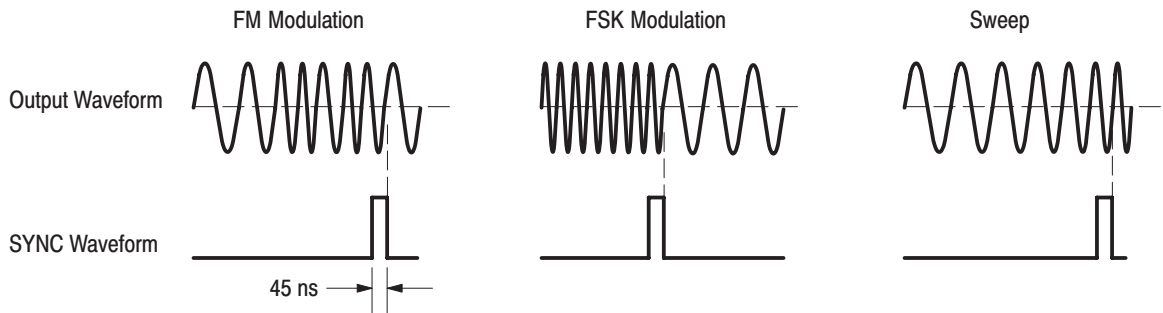

**Initial Settings**

When the INITIALIZE item selection is confirmed in the SYSTEM menu and the ENTER button is pressed, this instrument performs the initialize function.

When the initialize function is performed the instrument goes to power on default settings except for menu item selection states, cursor position, edit memory data, and edit menu item settings.

Table E-1 shows the list of initial settings.

**Table E-1: Initial Settings**

| Menu and Menu Item            | Selection and Value |
|-------------------------------|---------------------|
| <b>Setting Menu</b>           |                     |
| FUNC                          | SINE                |
| FREQ                          | 100.000 0 kHz       |
| AMPL                          | 1.000 V             |
| OFFSET                        | 0.000 V             |
| PHASE                         | 0 °                 |
| MODE                          | CONT                |
| MODUL                         | OFF                 |
| <b>PARAMETER Menu</b>         |                     |
| FUNC PARAMETER<br>PULSE DUTY  | 50 %                |
| MODE PARAMETER<br>BURST COUNT | 10                  |
| MODUL PARAMETER<br>SWP START  | 1.000 0 kHz         |
| SWP STOP                      | 100.00 kHz          |
| SWP TIME                      | 1.000 s             |
| SWP SPACING                   | LINEAR              |
| FM FUNC                       | SINE                |
| FM FREQ                       | 1.000 kHz           |
| FM DEVIA                      | 1.000 00 kHz        |
| FSK RATE                      | 1.000 kHz           |
| FSK FREQ                      | 10.000 0 kHz        |
| <b>RECALL Menu</b>            |                     |
| RECALL                        | 0                   |
| <b>SAVE Menu</b>              |                     |
| SAVE                          | 0                   |
| <b>Other Settings</b>         |                     |
| Channel                       | CH1                 |
| OUTPUT Switch<br>CH1          | OFF                 |
| CH2                           | OFF                 |

## Secure Settings (Factory Settings)

When the SECURE item selection is confirmed in the SYSTEM menu and the ENTER button is pressed, this instrument performs the secure function.

This function initializes all the instrument's setting items, edit memory data, and edit item settings and data stored in nonvolatile memory, thus restoring the instrument to the factory settings. However, the instrument's internal calibration data is not changed.

Table E-2 shows the list of secure settings in addition to performing INITIALIZE function.

**Table E-2: Secure Settings**

| Menu and Menu Item          | Selection and Value        |
|-----------------------------|----------------------------|
| <b>Edit Menu</b>            |                            |
| EDIT                        |                            |
| NUM OF POINTS               | 1000                       |
| NEW                         | SINE                       |
| COPY FROM                   | USER1                      |
| APPEND                      | USER1                      |
| PREPEND                     | USER1                      |
| LINE                        | 1,2047 ~ 1000,2047         |
| DATA                        | 1,2047                     |
| CUT                         | 1 <-> 1                    |
| Save                        | USER1                      |
| IMPORT FROM                 | TDS                        |
| <b>System Menu</b>          |                            |
| SYSTEM                      |                            |
| GPIB ADDRESS                | 1                          |
| GPIB CONFIG                 | T/L                        |
| STEP RECALL                 | OFF                        |
| LAST RECALL STEP            | 1                          |
| BEEP                        | ON                         |
| KEY CLICK                   | ON                         |
| LOCK WAVE                   | USER1 ~ USER4              |
| UNLOCK WAVE                 | NONE                       |
| <b>User Waveform Memory</b> |                            |
| EDIT                        |                            |
| USER1                       | Sampling Function SIN(X)/X |
| USER2                       | Double Exponential Pulse   |
| USER3                       | Damped Sine Wave           |
| USER4                       | NRZ Random Signal          |
| <b>Setting Memory</b>       |                            |
| RECALL(SAVE)                |                            |
| 0 ~ 19                      | Initial Settings           |

## Initial Settings for the Command Arguments

When the \*RST command is sent to the Arbitrary Function Generator or the instrument is powered on, the initial value for the command argument will be set.

The following table shows the list of initial settings for the command argument.

**Table E-3: Initial Value for the Command Argument**

| Command Header                                      | Initial Value | Page |
|---|---------------|------|
| FORMat:BORDer                                       | NORMal        | 4-31 |
| INSTrument:COUPlE                                   | NONE          | 4-33 |
| INSTrument:COUPlE:AMPLitude                         | NONE          | 4-33 |
| INSTrument:COUPlE:FREQuency                         | NONE          | 4-34 |
| INSTrument:COUPlE:OFFSet                            | NONE          | 4-35 |
| INSTrument:COUPlE:PHASe                             | NONE          | 4-36 |
| MODE<n>[:TYPE]                                      | CONTInuous    | 4-37 |
| MODE<n>:BCOunt                                      | 10            | 4-38 |
| OUTPut<n>[:STATe]                                   | 0 (OFF)       | 4-39 |
| [SOURce<n>]:AM:STATe                                | 0 (OFF)       | 4-42 |
| [SOURce<n>]:FM[:DEVIation]                          | 1.000 00 kHz  | 4-43 |
| [SOURce<n>]:FM:INTernal:FREQuency                   | 1.000 kHz     | 4-44 |
| [SOURce<n>]:FM:INTernal:FUNCTion                    | SINusoid      | 4-45 |
| [SOURce<n>]:FM:STATe                                | 0 (OFF)       | 4-45 |
| [SOURce<n>]:FREQuency[:CW]:FIXed]                   | 100.000 0 kHz | 4-46 |
| [SOURce<n>]:FREQuency:MODE                          | FIXed         | 4-47 |
| [SOURce<n>]:FREQuency:START                         | 1.000 0 kHz   | 4-48 |
| [SOURce<n>]:FREQuency:STOP                          | 100.00 kHz    | 4-49 |
| [SOURce<n>]:FSKey[:FREQuency]                       | 10.000 00 kHz | 4-50 |
| [SOURce<n>]:FSKey:INTernal:RATE                     | 1.000 kHz     | 4-52 |
| [SOURce<n>]:FSKey:STATe                             | 0 (OFF)       | 4-52 |
| [SOURce<n>]:FUNCTion[:SHAPe]                        | SINusoid      | 4-54 |
| [SOURce<n>]:PHASe[:ADJust]                          | 0             | 4-54 |
| [SOURce<n>]:PULSe:DCYClE                            | 50 %          | 4-55 |
| [SOURce<n>]:SWEp:TIME                               | 1.000 s       | 4-56 |
| [SOURce<n>]:SWEp:SPACing                            | LINear        | 4-57 |
| [SOURce<n>]:VOLTage[:LEVel][:IMMediate][:AMPLitude] | 1.000 V       | 4-58 |
| [SOURce<n>]:VOLTage[:LEVel][:IMMediate]:OFFSet      | 0.000 V       | 4-59 |

## Character Charts

Table E-4 shows the Arbitrary Function Generator character sets and Table E-5 shows the ASCII and GPIB codes.

**Table E-4: The Arbitrary Function Generator Character Set**

|          | 0               | 1                | 2                  | 3                 | 4              | 5              | 6               | 7                    |
|----------|-----------------|------------------|--------------------|-------------------|----------------|----------------|-----------------|----------------------|
| <b>0</b> | <b>NUL</b><br>0 |                  | <b>space</b><br>32 | <b>0</b><br>48    | <b>@</b><br>64 | <b>P</b><br>80 | <b>'</b><br>96  | <b>p</b><br>112      |
| <b>1</b> |                 | <b>Ω</b><br>17   | <b>!</b><br>33     | <b>1</b><br>49    | <b>A</b><br>65 | <b>Q</b><br>81 | <b>a</b><br>97  | <b>q</b><br>113      |
| <b>2</b> |                 | <b>Δ</b><br>18   | <b>”</b><br>34     | <b>2</b><br>50    | <b>B</b><br>66 | <b>R</b><br>82 | <b>b</b><br>98  | <b>r</b><br>114      |
| <b>3</b> |                 |                  | <b>#</b><br>35     | <b>3</b><br>51    | <b>C</b><br>67 | <b>S</b><br>83 | <b>c</b><br>99  | <b>s</b><br>115      |
| <b>4</b> |                 |                  | <b>\$</b><br>36    | <b>4</b><br>52    | <b>D</b><br>68 | <b>T</b><br>84 | <b>d</b><br>100 | <b>t</b><br>116      |
| <b>5</b> |                 |                  | <b>%</b><br>37     | <b>5</b><br>53    | <b>E</b><br>69 | <b>U</b><br>85 | <b>e</b><br>101 | <b>u</b><br>117      |
| <b>6</b> |                 | <b>μ</b><br>22   | <b>&amp;</b><br>38 | <b>6</b><br>54    | <b>F</b><br>70 | <b>V</b><br>86 | <b>f</b><br>102 | <b>v</b><br>118      |
| <b>7</b> | <b>'</b><br>7   |                  | <b>,</b><br>39     | <b>7</b><br>55    | <b>G</b><br>71 | <b>W</b><br>87 | <b>g</b><br>103 | <b>w</b><br>119      |
| <b>8</b> |                 | <b>—</b><br>24   | <b>(</b><br>40     | <b>8</b><br>56    | <b>H</b><br>72 | <b>X</b><br>88 | <b>h</b><br>104 | <b>x</b><br>120      |
| <b>9</b> | <b>HT</b><br>9  | <b>—</b><br>25   | <b>)</b><br>41     | <b>9</b><br>57    | <b>I</b><br>73 | <b>Y</b><br>89 | <b>i</b><br>105 | <b>y</b><br>121      |
| <b>A</b> | <b>LF</b><br>10 | <b>∞</b><br>26   | <b>*</b><br>42     | <b>:</b><br>58    | <b>J</b><br>74 | <b>Z</b><br>90 | <b>j</b><br>106 | <b>z</b><br>122      |
| <b>B</b> |                 | <b>ESC</b><br>27 | <b>+</b><br>43     | <b>;</b><br>59    | <b>K</b><br>75 | <b>[</b><br>91 | <b>k</b><br>107 | <b>{</b><br>123      |
| <b>C</b> | <b>±</b><br>12  |                  | <b>,</b><br>44     | <b>&lt;</b><br>60 | <b>L</b><br>76 | <b>\</b><br>92 | <b>l</b><br>108 | <b> </b><br>124      |
| <b>D</b> | <b>CR</b><br>13 | <b>≠</b><br>29   | <b>—</b><br>45     | <b>=</b><br>61    | <b>M</b><br>77 | <b>]</b><br>93 | <b>m</b><br>109 | <b>}</b><br>125      |
| <b>E</b> |                 | <b>~</b><br>30   | <b>.</b><br>46     | <b>&gt;</b><br>62 | <b>N</b><br>78 | <b>^</b><br>94 | <b>n</b><br>110 | <b>~</b><br>126      |
| <b>F</b> | <b>•</b><br>15  |                  | <b>/</b><br>47     | <b>?</b><br>63    | <b>O</b><br>79 | <b>-</b><br>95 | <b>o</b><br>111 | <b>rubout</b><br>127 |

**Table E-5: ASCII and GPIB Code Chart**

| B7<br>B6<br>BITS<br>B4 B3 B2 B1 | 0 0 0   |                       | 0 0 1 |                       | 0 1 0              |                     | 0 1 1 |      | 1 0 0      |                   | 1 0 1 |      | 1 1 0      |                                    | 1 1 1 |                 |
|---------------------------------|---------|-----------------------|-------|-----------------------|--------------------|---------------------|-------|------|------------|-------------------|-------|------|------------|------------------------------------|-------|-----------------|
|                                 | CONTROL |                       |       |                       | NUMBERS<br>SYMBOLS |                     |       |      | UPPER CASE |                   |       |      | LOWER CASE |                                    |       |                 |
| 0 0 0 0                         | 0       | NUL                   | 20    | DLE                   | 40                 | LA0                 | 60    | LA16 | 100        | TA0               | 120   | TA16 | 140        | SA0                                | 160   | SA16            |
|                                 | 0       |                       | 10    |                       | 20                 | SP                  | 30    | 0    | 40         | @                 | 50    | P    | 60         | ,                                  | 70    | p               |
| 0 0 0 1                         | 1       | GTL                   | 21    | LL0                   | 41                 | LA1                 | 61    | LA17 | 101        | TA1               | 121   | TA17 | 141        | SA1                                | 161   | SA17            |
|                                 | 1       | SOH                   | 11    | DC1                   | 21                 | !                   | 31    | 1    | 41         | A                 | 51    | Q    | 61         | a                                  | 71    | q               |
| 0 0 1 0                         | 2       |                       | 22    | DC2                   | 42                 | ”                   | 62    | LA18 | 102        | TA2               | 122   | TA18 | 142        | SA2                                | 162   | SA18            |
|                                 | 2       | STX                   | 12    |                       | 22                 | ”                   | 32    | 2    | 42         | B                 | 52    | R    | 62         | b                                  | 72    | r               |
| 0 0 1 1                         | 3       |                       | 23    | DC3                   | 43                 | LA3                 | 63    | LA19 | 103        | TA3               | 123   | TA19 | 143        | SA3                                | 163   | SA19            |
|                                 | 3       | ETX                   | 13    |                       | 23                 | #                   | 33    | 3    | 43         | C                 | 53    | S    | 63         | c                                  | 73    | s               |
| 0 1 0 0                         | 4       | SDC                   | 24    | DCL                   | 44                 | LA4                 | 64    | LA20 | 104        | TA4               | 124   | TA20 | 144        | SA4                                | 164   | SA20            |
|                                 | 4       | EOT                   | 14    | DC4                   | 24                 | \$                  | 34    | 4    | 44         | D                 | 54    | T    | 64         | d                                  | 74    | t               |
| 0 1 0 1                         | 5       | PPC                   | 25    | PPU                   | 45                 | LA5                 | 65    | LA21 | 105        | TA5               | 125   | TA21 | 145        | SA5                                | 165   | SA21            |
|                                 | 5       | ENQ                   | 15    | NAK                   | 25                 | %                   | 35    | 5    | 45         | E                 | 55    | U    | 65         | e                                  | 75    | u               |
| 0 1 1 0                         | 6       |                       | 26    | SYN                   | 46                 | LA6                 | 66    | LA22 | 106        | TA6               | 126   | TA22 | 146        | SA6                                | 166   | SA22            |
|                                 | 6       | ACK                   | 16    |                       | 26                 | &                   | 36    | 6    | 46         | F                 | 56    | V    | 66         | f                                  | 76    | v               |
| 0 1 1 1                         | 7       |                       | 27    | ETB                   | 47                 | LA7                 | 67    | LA23 | 107        | TA7               | 127   | TA23 | 147        | SA7                                | 167   | SA23            |
|                                 | 7       | BEL                   | 17    |                       | 27                 | ,                   | 37    | 7    | 47         | G                 | 57    | W    | 67         | g                                  | 77    | w               |
| 1 0 0 0                         | 10      | GET                   | 30    | SPE                   | 50                 | LA8                 | 70    | LA24 | 110        | TA8               | 130   | TA24 | 150        | SA8                                | 170   | SA24            |
|                                 | 8       | BS                    | 18    | CAN                   | 28                 | (                   | 38    | 8    | 48         | H                 | 58    | X    | 68         | h                                  | 78    | x               |
| 1 0 0 1                         | 11      | TCT                   | 31    | SPD                   | 51                 | LA9                 | 71    | LA25 | 111        | TA9               | 131   | TA25 | 151        | SA9                                | 171   | SA25            |
|                                 | 9       | HT                    | 19    | EM                    | 29                 | )                   | 39    | 9    | 49         | I                 | 59    | Y    | 69         | i                                  | 79    | y               |
| 1 0 1 0                         | 12      |                       | 32    | SUB                   | 52                 | LA10                | 72    | LA26 | 112        | TA10              | 132   | TA26 | 152        | SA10                               | 172   | SA26            |
|                                 | A       | LF                    | 1A    |                       | 2A                 | *                   | 3A    | :    | 4A         | J                 | 5A    | Z    | 6A         | j                                  | 7A    | z               |
| 1 0 1 1                         | 13      |                       | 33    | ESC                   | 53                 | LA11                | 73    | LA27 | 113        | TA11              | 133   | TA27 | 153        | SA11                               | 173   | SA27            |
|                                 | B       | VT                    | 1B    |                       | 2B                 | +                   | 3B    | ;    | 4B         | K                 | 5B    | [    | 6B         | k                                  | 7B    | {               |
| 1 1 0 0                         | 14      |                       | 34    | FS                    | 54                 | LA12                | 74    | LA28 | 114        | TA12              | 134   | TA28 | 154        | SA12                               | 174   | SA28            |
|                                 | C       | FF                    | 1C    |                       | 2C                 | ,                   | 3C    | <    | 4C         | L                 | 5C    | \    | 6C         | l                                  | 7C    | ;               |
| 1 1 0 1                         | 15      |                       | 35    | GS                    | 55                 | LA13                | 75    | LA29 | 115        | TA13              | 135   | TA29 | 155        | SA13                               | 175   | SA29            |
|                                 | D       | CR                    | 1D    |                       | 2D                 | -                   | 3D    | =    | 4D         | M                 | 5D    | ]    | 6D         | m                                  | 7D    | }               |
| 1 1 1 0                         | 16      |                       | 36    | RS                    | 56                 | LA14                | 76    | LA30 | 116        | TA14              | 136   | TA30 | 156        | SA14                               | 176   | SA30            |
|                                 | E       | SO                    | 1E    |                       | 2E                 | .                   | 3E    | >    | 4E         | N                 | 5E    | ^    | 6E         | n                                  | 7E    | ~               |
| 1 1 1 1                         | 17      |                       | 37    | US                    | 57                 | LA15                | 77    | UNL  | 117        | TA15              | 137   | UNT  | 157        | SA15                               | 177   | RUBOUT<br>(DEL) |
|                                 | F       | SI                    | 1F    |                       | 2F                 | /                   | 3F    | ?    | 4F         | O                 | 5F    | -    | 6F         | o                                  | 7F    |                 |
|                                 |         | ADDRESSED<br>COMMANDS |       | UNIVERSAL<br>COMMANDS |                    | LISTEN<br>ADDRESSES |       |      |            | TALK<br>ADDRESSES |       |      |            | SECONDARY ADDRESSES<br>OR COMMANDS |       |                 |

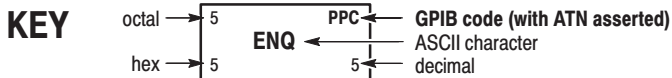

**Tektronix**  
 REF: ANSI STD X3.4-1977  
 IEEE STD 488.1-1987  
 ISO STD 646-2973

## SCPI Conformance

The Arbitrary Function Generator conforms to the 1994.0 version of the SCPI standard.

### SCPI Conformed Commands

The following commands are SCPI approved commands that are used by the Arbitrary Function Generator.

```

CALibration[:ALL]
CALibration[:ALL]?

FORMat:BORDER NORMal|SWAPped
FORMat:BORDER?

INSTrument:COUPle ALL|NONE
INSTrument:COUPle?
INSTrument:COUPle:AMPLitude ALL|NONE
INSTrument:COUPle:AMPLitude?
INSTrument:COUPle:FREQuency ALL|NONE
INSTrument:COUPle:FREQuency?
INSTrument:COUPle:OFFSet ALL|NONE
INSTrument:COUPle:OFFSet?
INSTrument:COUPle:PHASe ALL|NONE
INSTrument:COUPle:PHASe?

OUTPut<n>[:STATe] <Boolean>
OUTPut<n>[:STATe]?

[SOURce<n>]:AM:STATe <Boolean>
[SOURce<n>]:AM:STATe?
[SOURce<n>]:FM[:DEViation] <numeric_value>
[SOURce<n>]:FM[:DEViation]? [MINimum|MAXimum]
[SOURce<n>]:FM:INTernal:FREQuency <numeric_value>
[SOURce<n>]:FM:INTernal:FREQuency? [MINimum|MAXimum]
[SOURce<n>]:FM:INTernal:FUNCTion SINusoid|SQUare|TRIangle|RAMP|
USER[1]|USER2|USER3|USER4|EMEMory
[SOURce<n>]:FM:INTernal:FUNCTion?
[SOURce<n>]:FM:STATe <Boolean>
[SOURce<n>]:FM:STATe?
[SOURce<n>]:FREQuency[:CW]:FIXed <numeric_value>
[SOURce<n>]:FREQuency[:CW]:FIXed? [MINimum|MAXimum]
[SOURce<n>]:FREQuency:MODE CW|FIXed|SWEep
[SOURce<n>]:FREQuency:MODE?
[SOURce<n>]:FREQuency:STARt <numeric_value>
[SOURce<n>]:FREQuency:STARt? [MINimum|MAXimum]
[SOURce<n>]:FREQuency:STOP <numeric_value>
[SOURce<n>]:FREQuency:STOP? [MINimum|MAXimum]
[SOURce<n>]:FUNCTion[:SHAPe] SINusoid|SQUare|TRIangle|RAMP|PULSe|
PRNoise|DC|USER[1]|USER2|USER3|USER4|EMEMory
[SOURce<n>]:FUNCTion[:SHAPe]?

```





### NonSCPI Commands

The following commands are not SCPI approved commands and are designed specifically for the Arbitrary Function Generator. These commands follow the command syntax rules defined by the standard.

```

MODE<n>[:TYPE] CONTInuous|TRIGgered|BURSt
MODE<n>[:TYPE]?
MODE<n>:BCOunt <numeric_value>|INFinity
MODE<n>:BCOunt? [MINimum|MAXimum]

[SOURce<n>]:FSKey[:FREQuency] <numeric_value>
[SOURce<n>]:FSKey[:FREQuency]? [MINimum|MAXimum]
[SOURce<n>]:FSKey:INTernal:RATE <numeric_value>
[SOURce<n>]:FSKey:INTernal:RATE? [MINimum|MAXimum]
[SOURce<n>]:FSKey:STATe <Boolean>
[SOURce<n>]:FSKey:STATe?

SYSTem:SRECall[:STATe] <Boolean>
SYSTem:SRECall[:STATe]?
SYSTem:SRECall[:ULIMit <numeric_value>
SYSTem:SRECall[:ULIMit? [MINimum|MAXimum]

TRACe|DATA:LOCK[:STATe] <trace_name>,<boolean>
TRACe|DATA:LOCK[:STATe]? <trace_name>
    
```

## GPIB Interface Specification

Interface functions are defined by IEEE Std. 488.1 – 1987. These functions are used to send and receive messages and to control the Arbitrary Function Generator in response to messages. Table E–6 shows the interface functions built into this instrument. The abbreviations in parentheses after the names are codes that indicate commonly used interface functions defined by IEEE Std. 488.1 – 1987.

### Interface Functions

**Table E–6: GPIB Interface Function Implementation**

| Interface Function      | Implemented Subset | Capability  |
|-------------------------|--------------------|---|
| Acceptor Handshake (AH) | AH1                | Complete  |
| Source Handshake (SH)   | SH1                | Complete  |
| Listener (L)            | L4                 | Basic Listener<br>Unaddress if my talk address (MTA)<br>No listen only mode |

**Table E-6: GPIB Interface Function Implementation (Cont.)**

| <b>Interface Function</b> | <b>Implemented Subset</b> | <b>Capability</b>  |
|---------------------------|---------------------------|--|
| Talker (T)                | T6                        | Basic Talker, Serial Poll<br>Unaddress if my-listen-address (MLA)<br>No talk only mode |
| Device Clear (DC)         | DC1                       | Complete   |
| Remote/Local (RL)         | RL1                       | Complete   |
| Service Request (SR)      | SR1                       | Complete   |
| Parallel Poll (PP)        | PP0                       | None   |
| Device Trigger (DT)       | DT1                       | Complete   |
| Controller (C)            | C0                        | None   |
| Electrical Interface      | E2                        | Three-state driver   |

- Acceptor Handshake (AH). Allows a listening device to help coordinate the the proper reception of data. The AH function holds off initiation or termination of a data transfer until the listening device is ready to receive the next data byte.
- Source Handshake (SH). Allows a talking device to help coordinate the proper transfer of data. The SH function controls the initiation and termination of the transfer of data bytes.
- Listener (L). Allows a device to receive device-dependent data over the interface. This capability exists only when the device is addressed to listen. This function uses a one-byte address.
- Talker (T). Allows a device to send device-dependent data over the interface. This capability exists only when the device is addressed to talk. The function uses a one-byte address.
- Device Clear (DC). Allows a device to be cleared or initialized, either individually or as part of a group of devices.
- Remote/Local (RL). Allows a device to select between two sources for operating control. This function determines whether input information from the front-panel controls (local) or GPIB commands (remote) control the waveform generator.
- Service Request (SR). Allows a device to request service from the controller.
- Controller (C). Allows a device with the capability to send the device address, universal commands, and addressed commands to other devices over the interface to do so.

- Electrical Interface (E) Identifies the type of the electrical interface. The notation E1 indicates the electrical interface uses open collector drivers, while E2 indicates the electrical interface uses three-state drivers.

## Interface Messages

Table E-7 lists the GPIB Universal and Addressed commands that the Arbitrary Function Generator implements. A brief description of each function follows the table.

**Table E-7: GPIB Interface Messages**

| Interface Message               | Type <sup>1</sup> | Implemented |
|---------------------------------|-------------------|-------------|
| Device Clear (DC)               | UC                | Yes         |
| Local Lockout (LLO)             | UC                | Yes         |
| Serial Poll Disable (SPD)       | UC                | Yes         |
| Serial Poll Enable (SPE)        | UC                | Yes         |
| Parallel Poll Unconfigure (PPU) | UC                | No          |
| Go To Local (GTL)               | AC                | Yes         |
| Selected Device Clear (SDC)     | AC                | Yes         |
| Group Execute Trigger (GET)     | AC                | Yes         |
| Take Control (TCT)              | AC                | No          |
| Parallel Poll Configure (PPC)   | AC                | No          |

<sup>1</sup> **UC and AC stand for universal command and address command, respectively.**

- Device Clear (DCL). Clears (initializes) all devices on the bus that have a device clear function, whether the controller has addressed them or not.
- Local Lockout (LLO). Disables the return to local function.
- Serial Poll Enable (SPE). Puts all devices on the bus that have a service request function into the serial poll enabled state. In this state, each device sends the controller its status byte, instead of its normal output, after the device receives its talk address on the data lines. This function may be used to determine which device sent a service request.
- Serial Poll Disable (SPD). Changes all devices on the bus from the serial poll state to the normal operating state.
- Go To Local (GTL). Causes the listen-addressed device to switch from remote to local (front panel) control.
- Select Device Clear (SDC). Clears or initializes all listen-addressed devices.

- Group Execute Trigger (GET). Triggers all applicable devices and causes them to initiate their programmed actions.
- Take Control (TCT). Allows controller in charge to pass control of the bus to another controller on the bus.
- Parallel Poll Configure (PPC). Causes the listen-addressed device to respond to the secondary commands Parallel Poll Enable (PPE) and Parallel Poll Disable (PPD), which are placed on the bus following the PPC command. PPE enables a device with parallel poll capability to respond on a particular data line. PPD disables the device from responding to the parallel poll.



# Index

## A

- Abbreviation of Commands, 4–13
- Accessories, 1–3
- AM IN Connector, 2–6
- AM Modulation, 3–17
- AMPL Button, 3–10
- APPEND, 3–24
- Append a Waveform at the End of the Edit Waveform, 3–24
- Append a Waveform at the Front of the Edit Waveform, 3–25
- Arbitrary Block, 4–10
- Arguments, 4–8
- ASCII, code and character charts, E–6

## B

- BEEP, 3–33
- BOTH Button, 3–9
- BOTH Input Mode, 2–15
- Burst Count, 2–16
- Burst Mode, 3–15

## C

- \*CAL?, 4–28
- CALIBRATION, 3–37
- Calibration command
  - \*CAL?, 4–28
  - CALibration[:ALL], 4–29
- CALibration Subsystem Commands, 4–16
- Calibration Test, B–3
- CALibration[:ALL], 4–29
- Cancel the Both Input Mode, 2–15
- Certification, specifications, A–9
- CH / BOTH Button, 3–8
- CH Button, 3–9
- Channel Representation, 4–6
- Characteristic, specifications, A–1, A–7
- Characters, ASCII chart, E–6
- Cleaning the Instrument Exterior, C–2
- Cleaning the Instrument Interior, C–2
- \*CLS, 4–30
- Codes and Messages, 5–10
- Command Conventions, 4–13
- Command Descriptions, 4–28
- Command errors, 5–11
- Command Groups, 4–16

- Command Notation, 4–5
- Command Syntax, 4–5
- Common Command
  - \*CAL?, 4–28
  - \*CLS, 4–30
  - \*ESE, 4–30
  - \*ESR?, 4–31
  - \*IDN?, 4–32
  - \*OPC, 4–38
  - \*OPT?, 4–39
  - \*RCL, 4–40
  - \*RST, 4–41
  - \*SAV, 4–41
  - \*SRE, 4–60
  - \*STB?, 4–65
  - \*TRG, 4–74
  - \*TST?, 4–75
  - \*WAI, 4–75

- Compliances, specifications, A–9
- Concatenating Commands, 4–11
- Contacting Tektronix, xiii
- Continuous Mode, 3–14
- Conventions, xi
  - Self Test Procedure, B–1
- Copy a Waveform from User Waveform Memory, 3–24
- COPY CH1 → 2, 3–34
- Copy CH1 Parameter to CH2, 3–34
- COPY FROM, 3–24
- Creating a User Waveform and Output Waveform, 2–38
- CUT, 3–27
- Cut Data Points on the Designated Range, 3–27

## D

- Damped Sine Wave, 2–21
- DATA, 3–27
- Data Transfer Procedures, 4–15
- Decimal Numeric, 4–9
- Default Display, 2–7
- Dequeuing Event Code and Message, 5–10
- Device Dependent Device Errors
  - Calibration Errors, 5–15
  - Read/Write Errors, 5–15
  - Self Test Errors, 5–14
- Difference between SQUARE and PULSE, 3–13
- Display Firmware Version, 3–36
- Double Exponential Pulse, 2–20
- DSOLINK, 3–32
- Duty, 2–16

**E**

- EDIT Button, 3–22
- Editing a Waveform, 2–23
- Editing by Data Point, 3–27
- Editing, saving, and importing waveforms, 2–23
- Effective and Uneffective Trigger Input for the Dual
  - Channel Instrument, 3–15
- Electrical, specifications, A–1
- Enable Register, 5–7
- Enable Registers, Defined, 5–3
- Environment, 1–4
- Environmental, specifications, A–8
- Error, No events, 5–11
- Error and Event Status Block, 5–1
- \*ESE, 4–30, 5–7
- ESER register, 5–7
- \*ESR?, 4–31
- \*ESR? query, 5–5
- Event Codes and Messages, 5–10
- Event handling, 5–1
- Event Queue, 5–9
- Example 1: Set up a Waveform Output, 4–76
- Example 2: Waveform Transfer and Copy, 4–77
- Executing Calibration, 3–37
- Executing Factory Reset, 3–35
- Executing Initialization, 3–35
- Executing Self Test, 3–36
- Execution Errors, 5–12
- Exterior Inspection, C–1
- Exterior inspection, procedures, C–2

**F**

- Factory Settings, E–4
- Floating Connections, D–1
- FM DEVIA, 3–20
- FM FREQ, 3–20
- FM FUNC, 3–20
- FM Modulating Waveform, 3–20
- FM Modulating Waveform Frequency, 3–20
- FM Modulation, 3–17
- FORMat Subsystem Commands, 4–17
- FORMat:BORDER, 4–31
- FREQ Button, 3–9
- Frequency Deviation for the FM Modulation, 3–20
- Frequency Shift Rate, 3–21
- Front Panel Controls and Connectors, 2–2
- FSK FREQ, 3–22
- FSK Modulation, 3–17
- FSK RATE, 3–21
- FUNC Button, 3–12

- FUNC–PARAMETER Button, 3–13

**G**

- GPIB ADDRESS, 3–32
- GPIB CONFIG, 3–32
- GPIB Interface Specification, E–10
- GPIB System Configurations, 4–2

**H**

- Header, 4–6
- Header Mnemonic, 4–6
- Header Structure, 4–7
- Hop FREQUENCY, 3–22

**I**

- \*IDN?, 4–32
- IEEE–488.2 Common Commands, 4–27
- Import a Waveform from Other Instrument, 3–28
- IMPORT FROM, 3–28
- Importing a Waveform from Other Instrument, 2–48
- Importing Waveform, 2–24
- Initial Inspection, 1–2
- Initial Settings, E–2
- Initial Settings for the Command Arguments, E–5
- INITIALIZE, 3–35
- Input and output connectors, 2–5
- Inspection and Cleaning, C–1
- Installation, 1–4
- Installing for GPIB Communication, 4–1
- INSTrument:COUPlE, 4–33
- INSTrument:COUPlE:AMPLitude, 4–33
- INSTrument:COUPlE:FREQuency, 4–34
- INSTrument:COUPlE:OFFSet, 4–35
- INSTrument:COUPlE:PHASe, 4–36
- Interface Functions, E–10
- Interface Messages, E–12
- Interior inspection, procedures, C–2
- Internal Device Errors, 5–14

**K**

- KEY CLICK, 3–33

**L**

- LAST RECALL STEP, 3–33
- LCD Display, 2–7



LINE, 3–25  
 Line Editing, 3–25  
 Linked to DSO, 3–32  
 Lock User Waveform Memory, 3–34  
 LOCK WAVE, 3–34  
 Logical Data, 4–9

## M

Mechanical, specifications, A–7  
 Menu Button Functions, 3–8  
 Menu Item Display, 2–7  
 Menu Structure, 3–1  
 Menus other than Setting Menu, 3–2  
 Message Handling, 5–1  
 Miscellaneous, E–1  
 MODE Button, 3–14  
 MODE Subsystem Commands, 4–18  
 MODE–PARAMETER Button, 3–16  
 MODE<n>:BCOut, 4–38  
 MODE<n>[:TYPE], 4–37  
 Modify Modulation/Sweep, 2–17  
 MODUL Button, 3–16  
 MODUL–PARAMETER Button, 3–18  
 Modulation/Sweep to the Output Waveform, 2–17  
 Moving between menus, 2–8

## N

NEW, 3–24  
 Nondecimal Numeric, 4–9  
 NonSCPI Commands, E–10  
 Normal Recall Mode, 3–30  
 NRZ Random Signal, 2–22  
 NUM OF POINTS, 3–23  
 Number of Points, 3–23  
 Numeric Input, 2–10

## O

OCR register, 5–6  
 OENR register, 5–8  
 OEVR register, 5–6  
 OFF BUS, 3–33  
 OFFSET Button, 3–11  
 On/Off Setting for Key Click and Beep Sound, 3–33  
 \*OPC, 4–38  
 Operation for Setting Menu Items, 2–8  
 Operation for the Main Menus, 2–9  
 Operation Status Block, 5–3  
 \*OPT?, 4–39

Optional Accessories, 1–3  
 OUTPUT Connector, 2–5  
 Output Queue, 5–9  
 OUTPut Subsystem Commands, 4–19  
 OUTPut<n>[:STATe], 4–39  
 Outputting Standard Waveforms, 2–28  
 Outputting Waveform, 2–14

## P

PHASE Button, 3–11  
 Power cord identification, 1–9  
 Power Cord Options, 1–2  
 PREPEND, 3–25  
 Procedure  
   inspect exterior, C–2  
   inspect interior, C–2  
 Product Description, 1–1  
 Program and Response Messages, 4–5  
 Programming Examples, 4–76

## Q

QCR register, 5–7  
 QENR register, 5–8  
 QEVR register, 5–6  
 Query Error, 5–14  
 Query Responses, 4–13  
 Questionable Status Block, 5–3  
 Queue, 5–9  
   Event, 5–9  
   Output, 5–9

## R

\*RCL, 4–40  
 Rear Panel, 2–4  
 Rear Panel Controls and Connectors, 2–4  
 Recall a Setting, 2–18  
 RECALL Button, 3–30  
 Recall Menu Structure, 3–6  
 Register  
   ESER, 5–7  
   OCR, 5–6  
   OENR, 5–8  
   OEVR, 5–6  
   QCR, 5–7  
   QENR, 5–8  
   QEVR, 5–6  
   SBR, 5–4  
   SESR, 5–5

- SRER, 5–8
- Registers, 5–3
  - Status, 5–4
- Remote Interface, 4–1
- Repackaging for Shipment, 1–12
- Response Messages, 4–13
- Retrieving Response Messages, 4–14
- \*RST, 4–41

## S

- Sample Waveform
  - Damped Sine Wave, 2–21
  - Double Exponential Pulse, 2–20
  - NRZ Random Signal, 2–22
- Sample Waveforms, 2–19
- \*SAV, 4–41
- SAVE Button, 3–29
- Save Menu Structure, 3–6
- Save the Edit Waveform to the User Waveform
  - Memory, 3–28
- SAVE TO, 3–28
- Saving Edited Waveform, 2–24
- Saving Setup, 2–19
- SBR register, 5–4
- SCPI Conformance, E–8
- SCPI Conformed Commands, E–8
- SECURE, 3–35
- Secure Settings, E–4
- Selecting Modulation Sweep, 2–17
- Selecting Operation Mode, 2–16
- Selecting Waveform, 2–14
- SELF TEST, 3–36
- Self Test, 1–10, B–2
- Self Test and Calibration Procedure, B–1
- SESR register, 5–5
- Setting GPIB Address, 3–32
- Setting GPIB Configuration, 3–32
- Setting Instrument System, 2–26
- Setting Menu, 3–1
- Setting On / Off State for the Step Recall Mode, 3–33
- Setting Operation Mode, 2–16
- Setting the Both Input Mode, 2–15
- Setting the GPIB Parameters, 4–3
- Setting Up Sweep and Output Waveform, 2–33
- Setting Waveform Parameters, 2–15
- SHIFT Button, 3–8
- SOURCE Subsystem Commands, 4–19
  - [SOURCE<n>]:AM:STATE, 4–42
  - [SOURCE<n>]:FM:DEVIation], 4–43
  - [SOURCE<n>]:FM:INternal:FREQuency, 4–44
  - [SOURCE<n>]:FM:INternal:FUNction, 4–45
  - [SOURCE<n>]:FM:STATE, 4–45
  - [SOURCE<n>]:FREQuency[:CW]:FIXed], 4–46
  - [SOURCE<n>]:FREQuency:MODE, 4–47
  - [SOURCE<n>]:FREQuency:STARt, 4–48
  - [SOURCE<n>]:FREQuency:STOP, 4–49
  - [SOURCE<n>]:FSKey[:FREQuency], 4–50
  - [SOURCE<n>]:FSKey:INternal:RATE, 4–51
  - [SOURCE<n>]:FSKey:STATE, 4–52
  - [SOURCE<n>]:FUNction[:SHAPE], 4–53
  - [SOURCE<n>]:PHASE[:ADJust], 4–54
  - [SOURCE<n>]:PULSe:DCYCLE, 4–55
  - [SOURCE<n>]:SWEep:SPACing, 4–57
  - [SOURCE<n>]:SWEep:TIME, 4–56
  - [SOURCE<n>]:VOLTage[:LEVel][:IMMediate]:AM-PLitude, 4–58
  - [SOURCE<n>]:VOLTage[:LEVel][:IMMediate]:OFF-Set, 4–59
- Specifications
  - certification, A–9
  - characteristic, A–1, A–7
  - compliances, A–9
  - electrical, A–1
  - environmental, A–8
  - mechanical, A–7
  - specifications, A–1
- Specify the Last Setting Memory Number for the Step Recall, 3–33
- \*SRE, 4–60
- \*SRE command, 5–8
- SRER register, 5–8
- Standard Accessories, 1–3
- Starting Output, 2–15
- Status and error commands
  - \*ESE, 5–7
  - \*ESR?, 5–5
  - \*SRE, 5–8
    - STATus:OPERation:ENABLE, 5–8
    - STATus:QUESTionable:ENABLE, 5–8
- Status Register, 5–4
- Status Registers, Defined, 5–3
- STATus Subsystem Commands, 4–23
  - STATus:OPERation:CONDition?, 4–60
  - STATus:OPERation:ENABLE, 4–61, 5–8
  - STATus:OPERation[:EVENT]?, 4–61
  - STATus:PRESet, 4–62
  - STATus:QUESTionable:CONDition?, 4–62
  - STATus:QUESTionable:ENABLE, 4–63, 5–8
  - STATus:QUESTionable[:EVENT]?, 4–63
  - STATus:QUEue[:NEXT]?, 4–64
  - \*STB?, 4–65
- STEP RECALL, 3–33
- Step Recall, 3–30

Step Recall Mode, 3–31  
 String, 4–10  
 Style Fun, Style Name, Page# Sep  
   Equipment List, for Performance Verification, B–5  
   Performance Verification  
     Amplitude Accuracy Checks, B–11  
     DC Voltage Accuracy Checks, B–16  
     Equipment Required, B–5  
     Frequency Accuracy Checks, B–9  
     Modulation Function Checks, B–26  
     Of Warranted Characteristics, B–4  
     Operating Mode and Phase Checks, B–18  
     Output Waveform Checks, B–6  
     Prerequisites, B–4  
 Sweep, 3–16  
 Sweep Spacing, 3–20  
 Sweep Start Frequency, 3–19  
 Sweep Stop Frequency, 3–19  
 Sweep Time, 3–19  
 SWP, 3–16  
 SWP SPACING, 3–20  
 SWP START, 3–19  
 SWP STOP, 3–19  
 SWP TIME, 3–19  
 SYNC OUT Connector, 2–5  
 SYNC Signal Output, E–1  
 Syntactic Delimiters, 4–6  
 SYSTEM Button, 3–31  
 System events, 5–14  
 System Menu Structure, 3–6  
 SYSTEM Subsystem Commands, 4–24  
 SYSTEM:BEEPer:STATe, 4–65  
 SYSTEM:ERRor?, 4–66  
 SYSTEM:KLOCK, 4–66  
 SYSTEM:SECurity:IMMEDIATE, 4–67  
 SYSTEM:SRECall[:STATe], 4–68  
 SYSTEM:ULIMit, 4–68  
 SYSTEM:VERSion?, 4–69

## T

T / L, 3–32  
 Talk / Listen, 3–32  
 TRACe|DATA Subsystem Commands, 4–25  
 TRACe|DATA:CATalog?, 4–69

TRACe|DATA:COPIY, 4–70  
 TRACe|DATA[:DATA], 4–70  
 TRACe|DATA[:DATA]:LINE, 4–71  
 TRACe|DATA[:DATA]:VALue, 4–72  
 TRACe|DATA:DEFine, 4–72  
 TRACe|DATA:LOCK[:STATe], 4–73  
 TRACe|DATA:POINts, 4–74  
 \*TRG, 4–74  
 TRIGGER EXT IN Connector, 2–6  
 Trigger Input for the Dual Channel Instrument, 3–15  
 Triggered Mode, 3–14  
 \*TST?, 4–75  
 Tutorial 1. Outputting Standard Waveforms, 2–28  
 Tutorial 2. Setting Up Sweep and Output Waveform, 2–33  
 Tutorial 3. Creating a User Waveform and Output Waveform, 2–38  
 Tutorial 4. Importing a Waveform from Other Instrument, 2–48  
 Tutorials, 2–27

## U

Unit and SI Prefix, 4–10  
 Unlock User Waveform Memory, 3–34  
 UNLOCK WAVE, 3–34  
 Upper and Lower Case, 4–13  
 USER Waveform and EDIT Waveform, 3–13  
 Using the Control Buttons, 2–12  
 Using the Numeric Buttons, 2–11

## V

VERSION, 3–36  
 Voltage Settings, 1–7

## W

\*WAI, 4–75  
 Warranted characteristics, performance conditions for, A–1  
 Waveform Data Format, 4–15  
 Waveform Transfer, 4–14  
 Write a New Waveform, 3–24

