

Instructions



TDS 200-Series Extension Modules

070-9565-04

This document supports TDS 200-Series firmware version 1.06 and greater, TDS2HM firmware all versions, TDS2CM firmware version 1.04 and greater, and TDS2MM firmware version 1.00 and greater. Refer to *Read Me First* on page 1 for more information.



Copyright © Tektronix, Inc. All rights reserved.

Tektronix products are covered by U.S. and foreign patents, issued and pending. Information in this publication supercedes that in all previously published material. Specifications and price change privileges reserved.

Printed in the U.S.A.

Tektronix, Inc., P.O. Box 1000, Wilsonville, OR 97070-1000

TEKTRONIX and TEK are registered trademarks of Tektronix, Inc.

WARRANTY SUMMARY
(TDS2HM, TDS2CM, and TDS2MM Extension Modules)

Tektronix warrants that the products that it manufactures and sells will be free from defects in materials and workmanship for a period of three (3) years from the date of shipment from an authorized Tektronix distributor. If a product proves defective within the respective period, Tektronix will provide repair or replacement as described in the complete warranty statement.

To arrange for service or obtain a copy of the complete warranty statement, please contact your nearest Tektronix sales and service office.

EXCEPT AS PROVIDED IN THIS SUMMARY OR THE APPLICABLE WARRANTY STATEMENT, TEKTRONIX MAKES NO WARRANTY OF ANY KIND, EXPRESS OR IMPLIED, INCLUDING WITHOUT LIMITATION THE IMPLIED WARRANTIES OF MERCHANTABILITY AND FITNESS FOR A PARTICULAR PURPOSE. IN NO EVENT SHALL TEKTRONIX BE LIABLE FOR INDIRECT, SPECIAL OR CONSEQUENTIAL DAMAGES.

Table of Contents

General Safety Summary	ii
Preface	iv
Conventions	iv
Command Entry	v
Contacting Tektronix	vi
Getting Started	1
Dependencies	1
Features	2
Removing and Installing Modules	3
Checking Module Installation	6
Troubleshooting Module Installation	6
TDS2HM Hard Copy Module	7
Hard Copy Setup	8
Testing the Hard Copy Port	9
Printing an Oscilloscope Screen	9
TDS2CM Communications Module	10
RS-232 Setup	11
GPIB Setup	21
TDS2MM Measurement Module	27
Changed Math Operations	28
Signal Measurements	29
Using the FFT	30
Appendix A: Certifications and Compliances	42
Appendix B: Comparing GPIB and RS-232	43
Appendix C: Manuals	45



General Safety Summary

Review the following safety precautions to avoid injury and prevent damage to this product or any products connected to it. To avoid potential hazards, use the product only as specified.

Only qualified personnel should perform service procedures.

While using this product, you may need to access other parts of the system. Read the *General Safety Summary* in other system manuals for warnings and cautions related to operating the system.

Injury Precautions

Avoid Electric Overload. To avoid electric shock or fire hazard, do not apply a voltage to a terminal that is outside the range specified for that terminal.

Do Not Operate Without Covers. To avoid electric shock or fire hazard, do not operate this product with covers or panels removed.

Do Not Operate in Wet/Damp Conditions. To avoid electric shock, do not operate this product in wet or damp conditions.

Do Not Operate in an Explosive Atmosphere. To avoid injury or fire hazard, do not operate this product in an explosive atmosphere.

Product Damage Precautions

Do Not Operate With Suspected Failures. If you suspect there is damage to this product, have it inspected by qualified service personnel.

Safety Terms and Symbols

Terms in This Manual. These terms may appear in this manual:



CAUTION. *Caution statements identify conditions or practices that could result in damage to this product or other property.*

Terms on the Product. These terms may appear on the product:

DANGER indicates an injury hazard immediately accessible as you read the marking.

WARNING indicates an injury hazard not immediately accessible as you read the marking.

CAUTION indicates a hazard to property including the product.

Symbols on the Product. These symbols may appear on the product:



DANGER
High Voltage



Protective Ground
(Earth) Terminal



ATTENTION
Refer to Manual



Double
Insulated



Preface

These instructions describe how to install, set up, and test the TDS2CM, TDS2HM, and TDS2MM Extension modules. This manual presumes that you understand how to operate the TDS 200-Series oscilloscope.

Conventions

This manual uses the following conventions:

- Labeled oscilloscope panel buttons are shown in the manual in all uppercase letters. For example: UTILITY, HARDCOPY.
- On-screen menu items are shown in the manual with the first letter of each menu word in upper case. For example: Options, Recall Factory.
- A list of panel buttons, separated by the ► symbol, represents the order in which to push the listed buttons. For example, UTILITY ► Options ► RS-232 means that you first push the UTILITY panel button, then push the side menu button to the right of the Options menu item, and then push the side menu button to the right of the RS-232 menu item.

Command Entry

Follow these general rules when entering oscilloscope commands over the RS-232 or GPIB bus:

- You can enter commands in upper or lower case.
- You can abbreviate many oscilloscope commands. These abbreviations are shown in uppercase letters. For example, the command ACQUIRE:NUMAVg can be entered simply as ACQ:NUMAV or acq:numav.
- You can precede any command with white space characters. White space characters include any combination of the ASCII control characters 00 through 09 and 0B through 20 hexadecimal (0 through 9 and 11 through 32 decimal).
- The oscilloscope ignores commands that consist of just a combination of white space characters and line feeds.

Contacting Tektronix

Product Support	<p>For application-oriented questions about a Tektronix measurement product, call toll free in North America: 1-800-TEK-WIDE (1-800-835-9433 ext. 2400) 6:00 a.m. – 5:00 p.m. Pacific time</p> <p>Or contact us by e-mail: tm_app_supp@tek.com</p> <p>For product support outside of North America, contact your local Tektronix distributor or sales office.</p>
Service Support	<p>Contact your local Tektronix distributor or sales office. Or visit our web site for a listing of worldwide service locations.</p> <p>http://www.tek.com/measurement</p>
For other information	<p>In North America: 1-800-TEK-WIDE (1-800-835-9433) An operator will direct your call.</p>
To write us	<p>Tektronix, Inc. P.O. Box 1000 Wilsonville, OR 97070-1000</p>

Getting Started

This chapter describes important module and oscilloscope dependencies, and how to install and check the TDS 200-Series extension modules.

Read Me First

NOTE. Read the following text before installing your module. To display oscilloscope and module firmware version numbers, press **UTILITY** ► **System Status** ► **Misc.**

TDS2MM and TDS 200-Series

The TDS2MM Module only operates on TDS 200-Series oscilloscopes with firmware version v1.06 and greater. Contact Tektronix for information on how to upgrade your TDS 200-Series oscilloscope firmware.

Seiko Printer Support

Seiko printer support (DPU411, DPU412) is only available with the following firmware configurations:

Module and firmware	TDS 200 firmware
TDS2HM v1.00 and greater	v1.09 and greater
TDS2CM v1.04 and greater ¹	v1.09 and greater
TDS2MM v1.00 and greater	v1.06 and greater

¹ You cannot select the DPU411 or DPU412 over a remote interface with TDS2CM v1.03 and earlier.

Features

The following table lists the module features.

Module	Centronics	RS-232	GPIB	FFT, rise/fall time, pos/neg pulse width
TDS2HM	•			
TDS2CM	•	•	•	
TDS2MM	•	•	•	•

Removing and Installing Modules

The following sections describe how to safely remove and install a module on your oscilloscope.

Preventing Electrostatic Damage



CAUTION. *Electrostatic discharge (ESD) can damage components in the extension module and the oscilloscope. To prevent ESD, follow the steps below when installing, removing, or handling the extension modules:*

1. Always turn off the oscilloscope before removing or installing extension modules.
2. Handle extension modules as little as possible.
3. Transport and store extension modules in a static-protected bag or container.
4. Do not slide the extension module over any surface
5. Wear a grounded antistatic wrist strap to discharge the static voltage from your body while installing or removing an extension module from the oscilloscope.
6. Do not touch the oscilloscope extension module connector pins.
7. Do not use any devices capable of generating or holding a static charge in the work area where you install or remove extension modules.
8. Avoid handling modules in areas that have a floor or work-surface covering capable of generating a static charge.
9. Make sure that you install the extension module cover after you remove an extension module.

Removing an Extension Module



CAUTION. *Electrostatic discharge (ESD) can damage components in the extension module and the oscilloscope. To prevent ESD, follow the steps on page 3 when installing, removing, or handling the extension modules.*

After removing a module, install the dummy module cover to protect the contact pins.

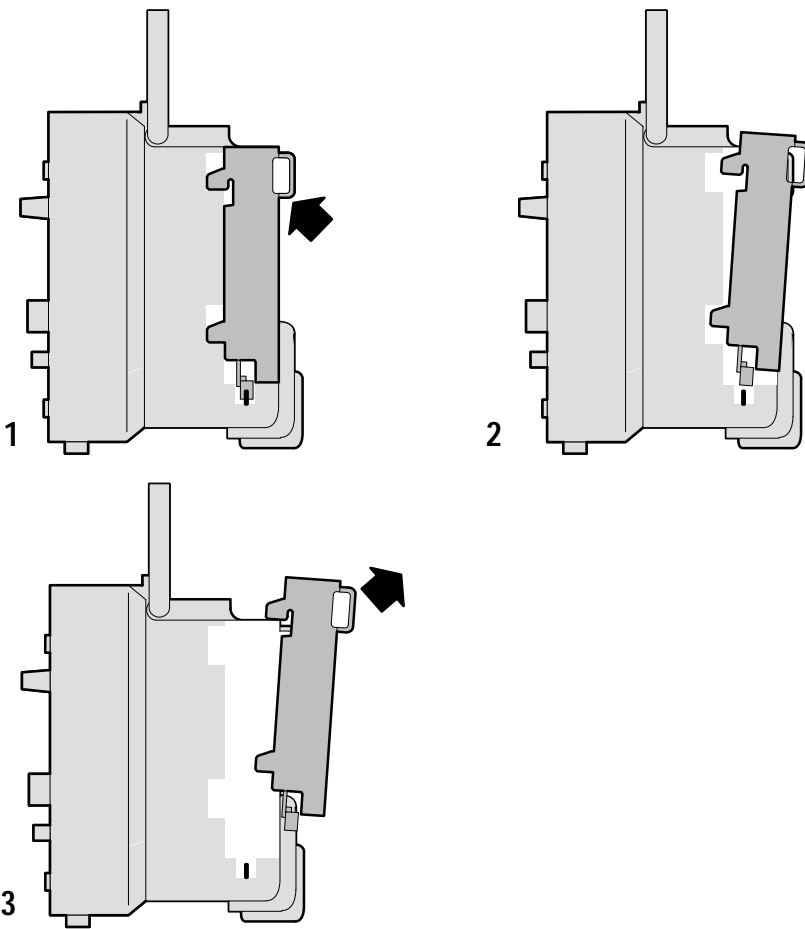

Installing an Extension Module

Make sure that you align the module connector to the oscilloscope connector pins before seating the module.

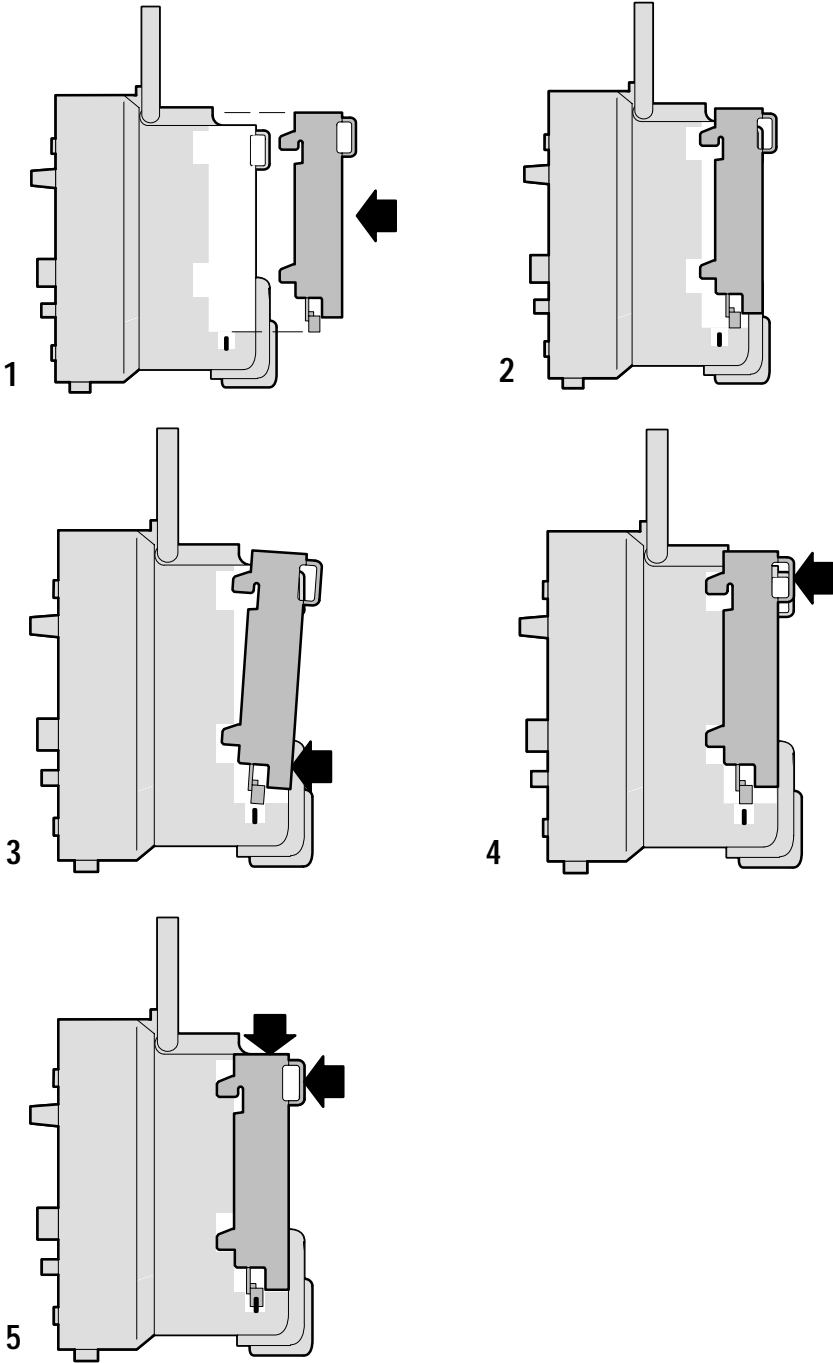

Checking Module Installation

To check that the extension module is correctly installed, turn on the oscilloscope. The power-up screen should include the message "Extension Module Passed". If the oscilloscope does not recognize the extension module at power-up, do the steps in *Troubleshooting Module Installation* below.

Troubleshooting Module Installation

If the oscilloscope does not recognize the extension module at power-up, do the following steps:

1. Turn off the oscilloscope.
2. Follow the ESD precautions listed on page 3.
3. Disconnect all cables from the extension module.
4. Remove the extension module (refer to page 4).
5. Examine the oscilloscope option connector for bent, broken, or missing pins. If any pins are bent, carefully straighten them out.
6. Reinstall the extension module onto the oscilloscope.
7. Turn on the oscilloscope. If the oscilloscope still does not show the module installed, contact the nearest Tektronix service center.

TDS2HM Hard Copy Module

The TDS2HM Module lets you print the oscilloscope screen data on a printer. This chapter describes how to set up and test the TDS2HM Hard Copy Extension Module. This information also applies to the hard copy portion of the TDS2CM Communications Module and the TDS2MM Measurement Module.

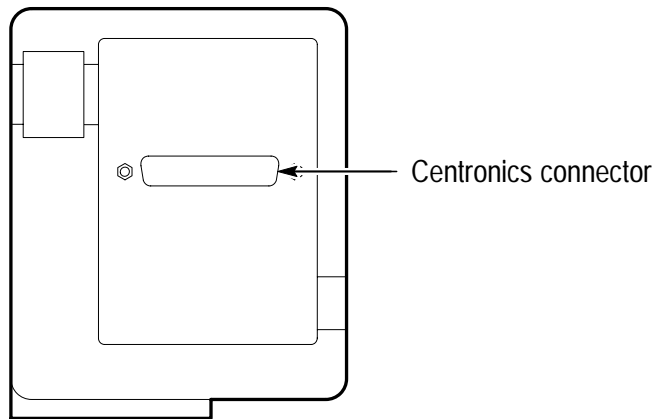

Hard Copy Setup

To setup the TDS2HM Module, do the following:

1. Turn on the oscilloscope.
2. Push UTILITY ► Options ► Hard Copy Setup.
3. Push the menu button next to the menu item to change the settings to match those of your printer device. The following table lists the settings you can change.

The oscilloscope stores these settings until you change them. Turning off the oscilloscope does not erase these settings.

Menu	Settings	Comments
Layout	Portrait, Landscape	Hard copy output orientation
Format	Epson, ThinkJet, DeskJet, LaserJet, BMP, PCX, EPSIMAGE, INTERLEAF, DPU411 ¹ , DPU412 ¹	Type of device connected to the hard copy port
Port (TDS2CM and TDS2MM only)	Centronics, RS-232, GPIB	Module port to which the printer is connected
Abort Hardcopy		Stops sending screen data to the hard copy device

¹ Refer to *Read Me First* on page 1 for more Seiko printer information.

Testing the Hard Copy Port

1. If you have already connected the oscilloscope to a printer, go to step 4.
2. Turn off the oscilloscope and the printer.
3. Connect the oscilloscope to the printer using the appropriate cable.
4. Turn on the oscilloscope and the printer.
5. If you have not done so already, do the hard copy setup appropriate for your extension module. Refer to page 8.
6. On the oscilloscope, push the HARDCOPY button. The printer should begin printing a copy of the oscilloscope screen after a few seconds.

Printing an Oscilloscope Screen

To print the screen data, push the HARDCOPY button. The oscilloscope takes a few seconds to capture the screen data and send it to the printer. The printer then begins printing a copy of the oscilloscope screen. Your printer settings determine how long it takes to print the screen data.

TDS2CM Communications Module

This chapter describes how to set up and test the TDS2CM Communications Extension Module RS-232 and GPIB interfaces. The TDS2CM Module includes all features of the TDS2HM Module, described in *TDS2HM Hard Copy Module* starting on page 7. This information also applies to the communications portion of the TDS2MM Measurement Module.

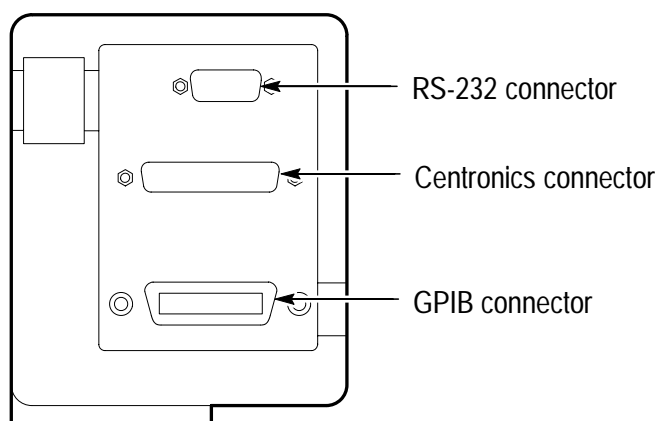

RS-232 Setup

This section describes how to set up and test the extension module RS-232 interface. RS-232 is an 8-bit serial communications standard that lets the oscilloscope communicate with an external RS-232 device such as a computer, terminal, or printer. The standard defines two device types: Data Terminal Equipment (DTE) and Data Communications Equipment (DCE). The TDS 200-Series oscilloscope is a DTE device.

RS-232 Conventions on page 19 describes RS-232 conventions. *RS-232 Connector Pinout Diagram* on page 20 shows a diagram of the 9-pin RS-232 connector with its pin numbers and signal assignments.

Selecting an RS-232 Cable

You will need an RS-232 cable to connect the oscilloscope to an external device. Use the following table to choose the correct cable to connect the module to your RS-232 equipment.

To connect the oscilloscope to	You need this type cable	Tektronix part number
PC/AT or laptop computers	9-pin female to 9-pin female, null modem	012-1379-00
PCs with 25-pin serial port connector	9-pin female to 25-pin female, null modem	012-1380-00
Serial printers, such as an HP Deskjet, and Sun workstations	9-pin female to 25-pin male, null modem	012-1298-00
Telephone modems	9-pin female to 25-pin male, modem	012-1241-00

Connecting an External Device

Follow these guidelines when connecting the module to an external RS-232 device:

- Use the correct cable (refer to the table on page 12).
- Use a cable that is no longer than 50 feet.
- Turn off the oscilloscope and the external device before inserting the cable into the connectors.
- Connect the oscilloscope only to a DCE device.
- Check that the oscilloscope signal ground (pin 5) is connected to the external device signal ground.
- Connect the chassis ground of the oscilloscope to the chassis ground of the external device.

RS-232 Settings

To set the oscilloscope RS-232 interface:

1. Push **UTILITY** ► **Options** ► **RS-232**.
2. Push the menu button next to the menu item to change settings to match those of the external device. The following table lists the settings you can change.

The oscilloscope stores these settings until you change them. Turning off the oscilloscope does not erase these settings.

Menu	Settings	Comments
Set to defaults		Sets the RS-232 interface to factory defaults (Baud=9600, Flow=Hardflag, EOL String=LF, Parity=None).
Baud	300, 600, 1200, 2400, 4800, 9600, 19200	Sets the data transmission rate.
Flow Control	Hardflag, Softflag, None	Sets data flow control (Softflag=Xon/Xoff, Hardflag= RTS/CTS). Use hardware flagging when transferring binary data.
EOL String	CR, LF, CR/LF, LF/CR	Sets the end-of-line terminator sent by the oscilloscope.
Parity	None, Even, Odd	Adds an error check bit (ninth bit) to each character.

Testing the RS-232 Interface

To test the oscilloscope RS-232 interface:

1. Connect the oscilloscope to a personal computer (PC) using an appropriate RS-232 cable (refer to the table on page 12).
2. Turn on the PC.
3. On the PC, run a terminal-emulator program such as the Microsoft Windows Terminal. Make sure the PC serial port is set as follows:

Function	Setting
Baud rate	9600
Data flow control	Hardflag
Parity	None
EOL string	LF

4. Turn on the oscilloscope.
5. Connect the oscilloscope probe to the channel 1 input connector. Attach the probe tip and ground lead to the PROBE COMP connectors.

The PROBE COMP signal is a square wave with a frequency of ≈ 1 kHz and a peak voltage of ≈ 5 V. The following figure shows how to hook up the probe to the oscilloscope.

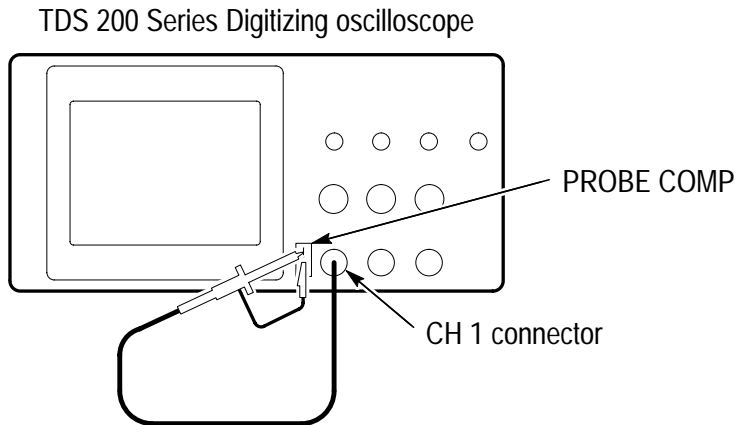

6. On the oscilloscope, push **UTILITY** ► **Options** ► **RS-232**.
7. Check that the menu settings match those listed in the table on page 15.
8. From your PC terminal program, type **ID?**, then press the **RETURN** key to send the command. The oscilloscope sends back its identification string, which should look similar to the following:

```
ID TEK/TDS 220,CF:91.1CT,FV:V1.09 TDS2CM:CMV:V1.04
```

If you do not get any response, refer to the troubleshooting steps that start on page 18.

9. Send the command **FACtory** to reset the oscilloscope to factory settings.
10. Send the command **AUTOSet EXECute** to have the oscilloscope automatically acquire the input signal.

- 11.** Send the command MEASUrement:IMMed:SOURCE CH1 to select measurements on channel 1.
- 12.** Send the command MEASUrement:IMMed:TYPe PK2 to set up the voltage measurement.
- 13.** Send the query MEASUrement:IMMed:VALue? to request the measurement result. The oscilloscope will respond with a result similar to 5.16E0, which is the voltage measurement of the PROBE COMP signal using the standard 10x probe.

This completes the RS-232 interface test.

RS-232 Troubleshooting

If the oscilloscope and the external device (personal computer or printer) have trouble communicating, use the following steps to correct the problem:

1. Verify that the module is working. Refer to *Checking Module Installation* on page 6.
2. Check that you are using the correct RS-232 cable. Determine whether your external device requires a null-modem or a straight-through connection. Refer to the table on page 12 for information about RS-232 cables.
3. Check that the RS-232 cable is firmly connected to both the oscilloscope and the correct port on the external device.
4. Check that the printer or the program on the personal computer is using the same port to which you connected the RS-232 cable. Try your program or printer again.
5. Check that the oscilloscope RS-232 settings match the settings used by the external device:
 - a. Determine the RS-232 settings for the external device.
 - b. On the oscilloscope, push UTILITY ► Options ► RS-232.
 - c. Set the oscilloscope to match the settings of the external device.
 - d. Try your terminal-emulator program or printer again.
6. Try setting both the oscilloscope and the external device to a slower baud rate.

RS-232 Conventions

There are processing conventions that are specific to the RS-232 interface. The next sections discuss transferring binary data, processing break signals, reporting RS-232 I/O errors, and checking command status.

Transferring Binary Data

When using the RS-232 port to transfer binary data to the oscilloscope, note the following points:

- Use hardware flagging (RTS/CTS) whenever possible. Hardware flagging guarantees no data loss.
- All eight bits of binary data contain meaningful information. To make sure that all eight bits are received or transmitted, configure the external RS-232 device to receive and transmit eight-bit characters (set the RS-232 word length to eight bits).

Reporting RS-232 I/O Errors

Errors are reported when there is a problem with parity, framing, or input/output buffer overruns. To report errors, the oscilloscope posts an event code. When an error occurs, the oscilloscope discards all input and output and waits for a new command.

Checking Command Status

If you want to check the status of each command sent, you can append an `*STB?` query after every command and read the response string.

Processing Break Signals

When the oscilloscope senses a break signal on the RS-232 port, it returns DCL followed by the end of line terminator. Internally, the oscilloscope acts as if it received a GPIB <DCL> command, causing the oscilloscope to erase the contents of the input and output buffers and then wait for a new command. Break signals do not change oscilloscope settings or stored data and do not interrupt front-panel operation or nonprogrammable functions.

If a break signal is sent in the middle of a character stream, several characters immediately preceding or following the break can be lost. The controller should wait until it receives the DCL and the end of line terminator string before sending more characters.

RS-232 Connector Pinout Diagram

The following diagram shows the pin numbering and signal assignments for the TDS2CM RS-232 connector.

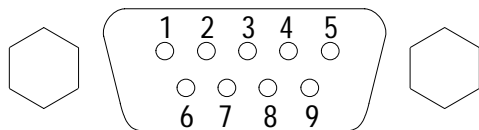

- | | | |
|---|---------------------------|----------|
| 1 | No connection | |
| 2 | Receive data (RXD) | (input) |
| 3 | Transmit data (TXD) | (output) |
| 4 | Data terminal ready (DTR) | (output) |
| 5 | Signal ground (GND) | |
| 6 | Data set ready (DSR) | (input) |
| 7 | Request to send (RTS) | (output) |
| 8 | Clear to send (CTS) | (input) |
| 9 | No connection | |

GPIB Setup

This section describes how to set up and test the extension module GPIB interface. GPIB is an 8-bit parallel communications standard that lets the oscilloscope communicate with an external device such as a controller, computer, terminal, or printer.

Connecting to External GPIB Devices

Follow these guidelines when you connect your oscilloscope to a GPIB network:

- Turn off the oscilloscope and all external devices before connecting the oscilloscope to the GPIB network.
- Connect the oscilloscope to the GPIB network. Use an appropriate GPIB cable. You can stack cable connectors. The following table lists cables that you can order to connect the oscilloscope to the GPIB network.

Cable type	Tektronix part number
GPIB, 6.6 feet (2 meters)	012-0991-00
GPIB, 3.3 feet (1 meter)	012-0991-01

- Assign a unique device address to the oscilloscope. No two devices can share the same device address. The following section describes how to set the oscilloscope GPIB interface.
- Turn on at least two-thirds of the GPIB devices while using the network.

GPIB Settings

To set the oscilloscope GPIB interface:

1. If you have not done so yet, connect the oscilloscope to the GPIB network.
2. On the oscilloscope, push **UTILITY** ► **Options** ► **GPIB Setup**.
3. Push the menu button next to the menu item to change the settings to assign a unique address to the oscilloscope. The following table lists the settings you can change.

The oscilloscope stores these settings until you change them. Turning off the oscilloscope does not erase these settings.

Menu	Settings	Comments
Address	0 ... 30	Sets oscilloscope GPIB bus address
Bus Connection	Talk-listen, Off-bus	Select Talk-listen to turn on oscilloscope GPIB bus communications. Select Off-bus to turn off oscilloscope GPIB bus communications.

Testing the GPIB Interface

To test the oscilloscope GPIB interface, you will need to refer to the documentation that came with your controller.

The following procedure verifies communication with the oscilloscope by acquiring a signal and returning a voltage measurement. This procedure assumes that the oscilloscope is connected to the GPIB network, the oscilloscope has been assigned a unique bus address, and that the controller software is running.

To test the GPIB interface:

1. Connect the oscilloscope probe to the channel 1 input connector. Attach the probe tip and ground lead to the PROBE COMP connectors. The figure on the next page shows how to hook up the probe to the oscilloscope.

The PROBE COMP signal is a square wave with a frequency of ≈ 1 kHz and a peak voltage of ≈ 5 V.

2. In the controller software, send the ID? command to the oscilloscope. The oscilloscope should send back its identification string which looks similar to the following:

```
ID TEK/TDS 220,CF:91.1CT,FV:V1.09 TDS2CM:CMV:V1.04
```

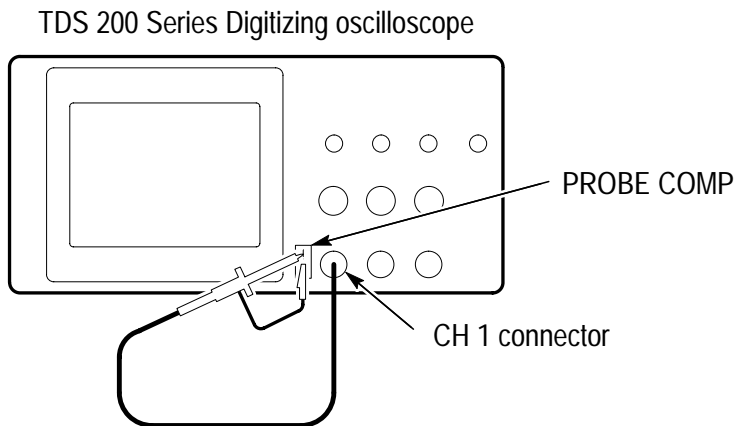

3. Send the command `FACtory` to reset the oscilloscope to factory settings.
4. Send the command `AUTOSet EXECute` to have the oscilloscope automatically acquire the input signal.
5. Send the command `MEASUrement:IMMed:SOURCE CH1` to select measurements on channel 1.
6. Send the command `MEASUrement:IMMed:TYPE PK2` to set up the voltage measurement.
7. Send the query `MEASUrement:IMMed:VALue?` to request the measurement result. The oscilloscope will respond with a result similar to `5.16E0`, which is the voltage measurement of the `PROBE COMP` signal using the standard 10x probe.

This completes the GPIB interface test.

GPIB Network Conventions

Follow these guidelines when you assemble your GPIB network:

- Connect the GPIB devices in a star, linear, or combination star/linear network, as shown in the following figure.

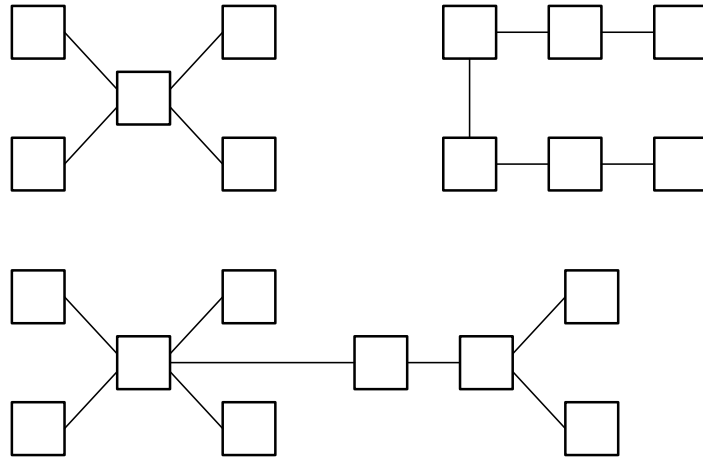

- Do not use loop or parallel configurations (shown in the following figure).

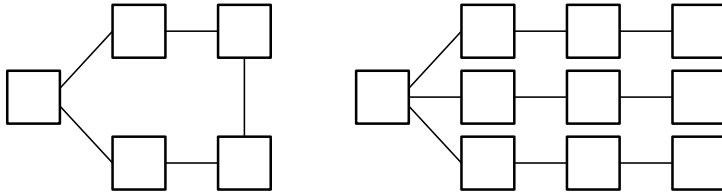

- The maximum number of devices in a network is 15.
- The maximum cable length between any two devices is 6.6 feet (2 meters).
- The maximum cable length in the entire network is 65 feet (20 meters).
- Assign a unique device address to each device on the network. No two devices can share the same device address.



TDS2MM Measurement Module

This section describes the operation of the TDS2MM Measurement Extension Module. The TDS2MM Module includes all communications capabilities of the TDS2CM Module, and adds these new measurement capabilities to the TDS 200-Series oscilloscopes:

- Rise time, fall time, positive pulse width, and negative pulse width (discussed in *Signal Measurements*, on page 29)
- Fast Fourier Transform (FFT) (discussed in *Using the FFT*, starting on page 30)

Changed Math Operations

The TDS2MM Module changes the following math operations:

- The TDS2MM Module does not have the CH1–CH2 and CH2–CH1 math functions. To do the same functions, invert the channel you want to subtract (using the CH1 or CH2 menu) and then select the CH1+CH2 math function.

Default channel subtraction	TDS2MM channel subtraction	Comments
CH1–CH2	CH1+(-CH2)	(-CH2) means invert channel 2
CH2–CH1	(-CH1)+CH2	(-CH1) means invert channel 1

- The TDS2MM Module moves the channel invert function from the MATH menu to the Vertical CH1 and CH2 menus.

Signal Measurements

Push the MEASURE button to display the automated measurement menu. The new measurements are in the Type menu. The TDS2MM Module automatically determines the 10%, 50%, and 90% waveform points.

Type	Definition
Rise Time	Measures the time between 10% and 90% of the first rising edge of the waveform. Rising edge must be displayed to measure.
Fall Time	Measures the time between 90% and 10% of the first falling edge of the waveform. Falling edge must be displayed to measure.
Pos Width	Measures the time between the first rising edge and the next falling edge at the waveform 50% level. Rising and falling edges must be displayed to measure.
Neg Width	Measures the time between the first falling edge and the next rising edge at the waveform 50% level. Falling and rising edges must be displayed to measure.

Using the FFT

The FFT process mathematically converts a time-domain signal into its frequency components. FFT waveforms are useful in the following applications:

- Testing impulse response of filters and systems
- Measuring harmonic content and distortion in systems
- Characterizing noise in DC power supplies
- Analyzing vibration
- Analyzing harmonics in 50 and 60 Hz power lines

There are five steps to using the FFT:

1. Set up the source (time-domain) waveform
2. Display the FFT waveform
3. Select the FFT window type
4. Adjust the sample rate to display fundamental frequency and harmonics without aliasing
5. Use zoom controls and the cursors to magnify and measure the FFT waveform

Setting Up the Time-Domain Waveform

It is important to correctly set up the time-domain (YT) waveform to produce a useable FFT waveform. Follow these steps to set up the YT waveform:

1. Press AUTOSET to display a YT waveform.
2. Position the YT waveform vertically at center screen (zero divisions) to get a true DC value. A standard FFT computation yields a DC value that is twice as large as it should be with respect to the other frequencies. The TDS2MM Module corrects this error.
3. Position the YT waveform horizontally so that the waveform area of interest is contained in the center eight divisions. The TDS2MM Module uses the center 2048 points of the time-domain waveform to transform into an FFT waveform.
4. Set the YT waveform VOLTS/DIV so that the signal does not go off screen. (Off screen waveform peaks can result in FFT waveform errors).
5. Set the YT waveform SEC/DIV to provide the resolution you want in the FFT waveform. It is important to show a number of signal cycles if possible. Setting the time/division to a faster setting means the FFT waveform shows a larger frequency range, has less frequency resolution and reduces aliasing (refer to *Aliasing* on page 38 for more information).

In many cases, you can produce a useful FFT waveform even if the YT waveform is not triggered. This is especially true if your signal is periodic or random (noisy). However, transient or burst waveforms should be triggered and positioned as close as possible to center screen.

Nyquist Frequency

The highest frequency that any real-time digitizing oscilloscope can measure without errors is one-half the sample rate. This frequency is called the Nyquist frequency. Frequency information above the Nyquist frequency is undersampled, causing a situation known as aliasing (refer to *Aliasing* on page 38).

The TDS2MM Module transforms the center 2048 points of the time-domain waveform into an FFT waveform. The resulting FFT waveform contains 1024 points that go from DC (0 Hz) to the Nyquist frequency.

Normally, the display compresses the FFT waveform horizontally into 250 points, but you can use the FFT Zoom function to expand the FFT waveform to more clearly see the frequency components at each of the 1024 data points in the FFT waveform.

NOTE. *The oscilloscope bandwidth rolls off slowly above 20 MHz (Bandwidth Limit ON), 60 MHz (TDS 210), or 100 MHz (TDS 220). Therefore, the FFT waveform can show valid frequency information higher than the oscilloscope bandwidth. However, the magnitude information above the bandwidth will not be accurate.*

Displaying the FFT Waveform

Push the MATH button to display the math menu. Use the menu buttons to select the FFT source channel, window algorithm, and display magnification. You can display only one FFT waveform at a time.

Menu	Settings	Comments
MATH	CH1+CH2	Displays sum of channel 1 and 2 signals (refer to <i>Changed Math Operations</i> on page 28)
	FFT CH1	Switches between the channel 1 FFT and YT waveforms (selected = FFT)
	FFT CH2	Switches between the channel 2 FFT and YT waveforms (selected = FFT)
	Window	Selects the FFT window type (Hanning, Flattop, Rectangular)
	FFT Zoom	Changes the horizontal magnification of the FFT display (X1, X2, X5, X10)

The FFT Display

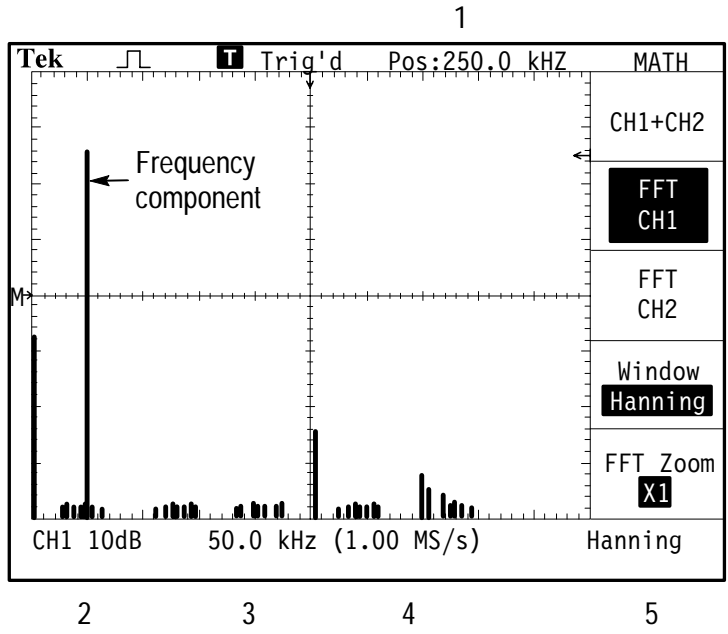

1. Frequency at the center graticule line
2. Vertical scale in dB per division (0 dB = 1 V_{RMS})
3. Horizontal scale in frequency per division
4. Sample rate in number of samples per second
5. FFT window type

FFT Windows

Windows reduce spectral leakage in the FFT waveform. The FFT assumes that the YT waveform repeats forever. With an integral number of cycles (1, 2, 3, ...), the YT waveform starts and ends at the same amplitude and there are no discontinuities in the signal shape.

A non-integral number of cycles in the YT waveform causes the signal start and end points to be at different amplitudes. The transitions between the start and end points cause discontinuities in the signal that introduce high-frequency transients.

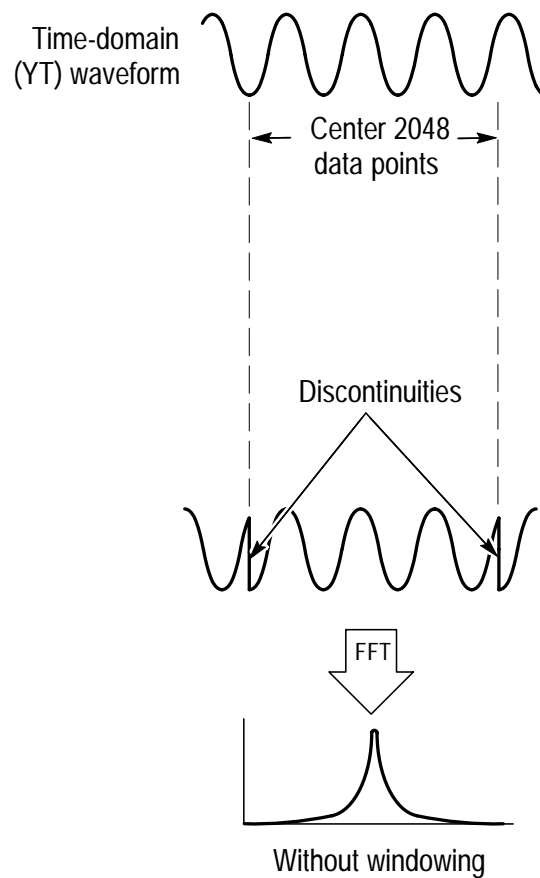

Applying a window to the YT waveform changes the waveform so that the start and stop values are close to each other, reducing the discontinuities.

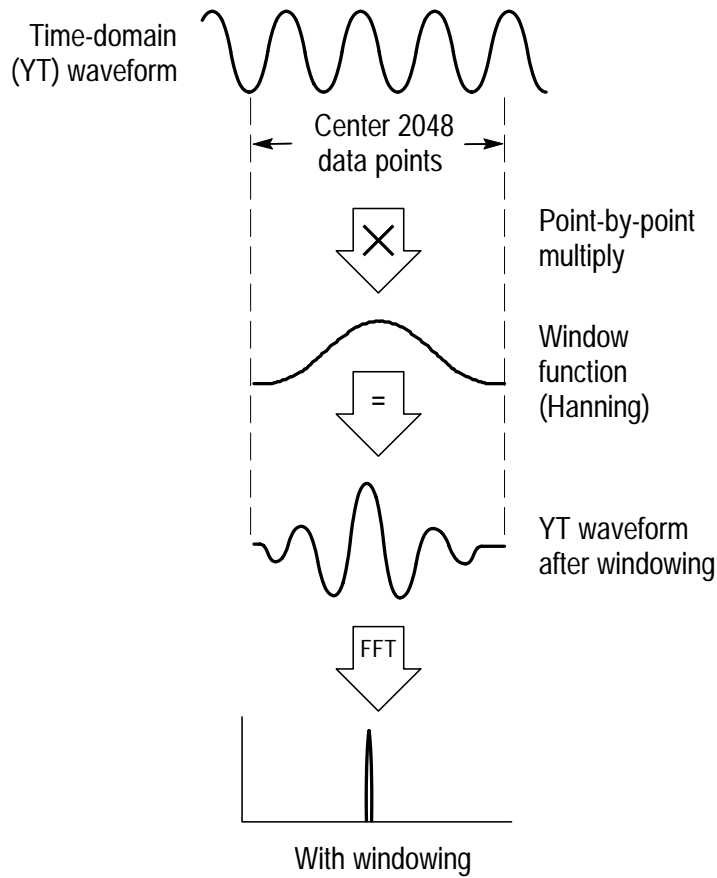

Selecting an FFT Window

The TDS2MM Module provides three FFT windows. Each window is a trade-off between frequency resolution and amplitude accuracy. What you want to measure and your source signal characteristics help determine which window to use. Use the following guidelines to select the best window.

Window	Measure	Characteristics
Hanning	Periodic waveforms	Better frequency, poorer magnitude accuracy than Flattop.
Flattop	Periodic waveforms	Better magnitude, poorer frequency accuracy than Hanning.
Rectangular	Pulses or transients	Special-purpose window for waveforms that do not have discontinuities. This is essentially the same as no window.

Aliasing

Problems occur when the oscilloscope acquires a time-domain waveform containing frequency components that are greater than the Nyquist frequency (refer to *Nyquist Frequency* on page 32). The frequency components that are above the Nyquist frequency are undersampled, appearing as lower frequency components that “fold back” around the Nyquist frequency. These incorrect components are called aliases.

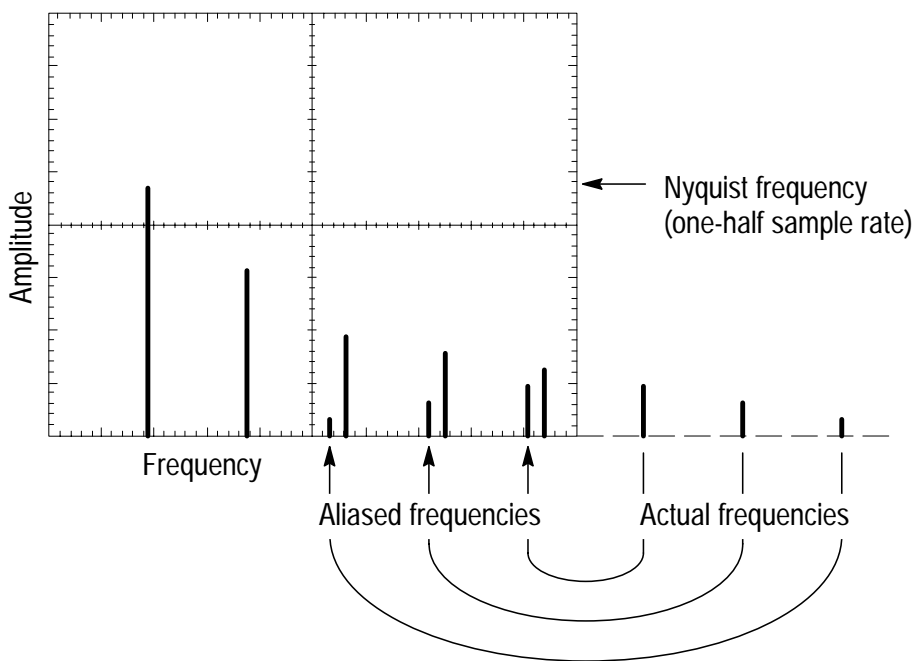

Eliminating Aliases

Use the following methods to eliminate aliases:

- Increase the sample rate by adjusting the time/division to a faster setting. Since you increase the Nyquist frequency as you increase the sample rate, the aliased frequency components should appear at their proper frequency. If too many frequency components are shown on the screen, use FFT Zoom to magnify the FFT waveform.
- Use a filter on the source signal to bandwidth limit the source waveform to frequencies below that of the Nyquist frequency.
- Recognize and ignore the aliased frequencies.

Horizontal Zoom and Position

The FFT Zoom menu lets you horizontally magnify the FFT waveform without changing the sample rate. Zoom factors are X1 (default), X2, X5, and X10. At zoom factor X1, and with the waveform centered in the graticule, the left graticule line is at 0 Hz and the right graticule line is at the Nyquist frequency.

When you change the zoom factor, the FFT waveform is magnified about the center graticule line. In other words, the axis of horizontal magnification is the center graticule line.

The Horizontal Position knob moves the FFT waveform left or right on the screen. Rotate the knob clockwise to move the waveform to the right.

Vertical Zoom and Position

The channel vertical knobs become zoom and position controls for their respective channels when displaying the FFT waveform. The VOLTS/DIV knob provides zoom factors of X0.5, X1 (default), X2, X5, and X10. The FFT waveform is vertically magnified about the M marker (math waveform reference point on the left edge of the display).

The Vertical Position knob moves the FFT waveform up or down on the screen. Rotate the knob clockwise to move the waveform up.

Measuring FFT Waveforms Using Cursors

You can take two measurements on FFT waveforms: magnitude (in dB) and frequency (in Hz). Magnitude is referenced to 0 dB, where 0 dB equals 1 V RMS. You can use the cursors to take measurements at any zoom factor.

Push **CURSOR** ► **Source** and select **Math**. Push the **Type** menu button to select between **Magnitude** and **Frequency**. Use the **Vertical Position** knobs to move cursors 1 and 2.

Use horizontal cursors to measure magnitude and vertical cursors to measure frequency. The menu boxes display the delta between the two cursors, the value at cursor 1 position, and the value at cursor 2 position. Delta is the absolute value of cursor 1 minus cursor 2.

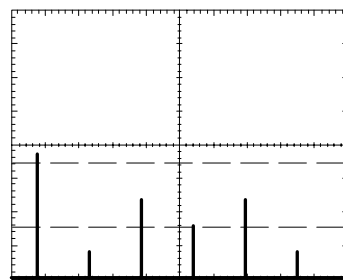

Magnitude cursors

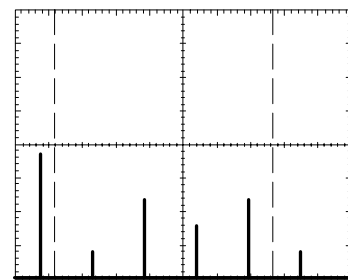

Frequency cursors

You can also do a frequency measurement by using the **Horizontal Position** knob to position a frequency component on the center graticule line and read the frequency at the top right of the display.

Appendix A: Certifications and Compliances

The TDS 200-Series Extension Modules meet the following certifications and compliances.

Certifications and Compliances

<p>EC Declaration of Conformity</p>	<p>Meets intent of Directive 89/336/EEC for Electromagnetic Compatibility for Product Safety. Compliance was demonstrated to the following specifications as listed in the Official Journal of the European Communities:</p> <p>EN 50081-1 Emissions:</p> <ul style="list-style-type: none"> EN 55011 Class A Radiated and Conducted Emissions EN 60555-2 AC Power Line Harmonic Emissions <p>EN 50082-1 Immunity:</p> <ul style="list-style-type: none"> IEC 801-2 Electrostatic Discharge Immunity IEC 801-3 RF Electromagnetic Field Immunity IEC 801-4 Electrical Fast Transient/Burst Immunity IEC 801-5 Power Line Surge Immunity
<p>U.S. Certifications</p>	<p>FCC 47 CFR Part 15, Subpart B, Class A</p>
<p>Australia/New Zealand Declaration of Conformity</p>	<p>Meets intent of Australian Radiocommunications Act of 1992. Compliance demonstrated and declared for the following specification:</p> <p>AS/NZS 2064.1/2 Industrial, Scientific, and Medical Equipment</p>

Appendix B: Comparing GPIB and RS-232

The following table provides an in-depth comparison of the GPIB and RS-232 interfaces. You should select the interface that best meets your requirements.

Operating Attribute	GPIB	RS-232
Cable	IEEE-488 Std.	9-wire
Data flow control	Hardware, 3-wire hand-shake	Flagging: soft (XON/XOFF), hard (RTS/CTS)
Data format	8-bit parallel	8-bit serial
Interface control	Operator low-level control message	None
Interface messages	Most IEEE-488 Std.	Device clear using a break signal
Interrupts reported	Service requests, status and event code	None, must be polled for status

Appendix B: Comparing GPIB and RS-232

Operating Attribute	GPIB	RS-232
Message termination (Receive)	Hardware EOL, software LF, or both	Software CR, LF, CRLF, LFCR
Message termination (Transmit)	Hardware EOL, software LF	Software CR, LF, CRLF, LFCR
Timing	Asynchronous	Asynchronous
Transmission path length (max)	≤ 2 meters between devices; ≤ 20 meters total cabling	≤ 15 meters
Speed	200 kBytes/sec	19,200 bits/sec
System environment	Multiple devices (≤ 15)	Single terminal (point-to-point connection)

Appendix C: Manuals

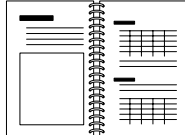

TDS 210 & TDS 220 Service Manual. The service manual (English 070-9693-XX) provides module level repair information.



TDS 210 & TDS 220 User Manuals. The user manual is available in these languages:

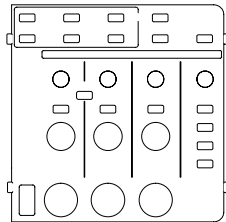

English	070-8483-XX
French	070-8520-XX*
German	070-8484-XX*
Italian	070-8980-XX*
Spanish	070-9560-XX*
Portuguese	070-9561-XX*
Japanese	070-9562-XX
Korean	070-9564-XX
Simplified Chinese	070-9563-XX
Traditional Chinese	070-9568-XX

*These manuals contain a language overlay for the front-panel controls.

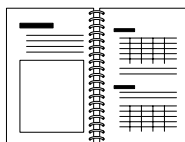

TDS 200-Series Extension Module Instructions. The module instructions are available in these languages:

English	070-9565-XX
French	070-9567-XX
German	070-9566-XX
Italian	070-9569-XX
Spanish	070-9570-XX
Portuguese	070-9571-XX
Japanese	070-9572-XX
Korean	070-9575-XX
Simplified Chinese	070-9573-XX
Traditional Chinese	070-9574-XX

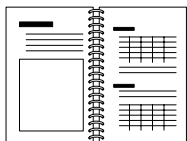

TDS 200-Series Two Channel Digital Oscilloscope Programmer Manual. The programmer manual (English 070-9576-XX) provides command syntax for remote control of the TDS 200-Series oscilloscope.
